



# **Network Video Recorder GUI and Web UI User Guide**

## Copyright Statement

© 2022 Shenzhen Tenda Technology Co., Ltd. All rights reserved.

**Tenda** is a registered trademark legally held by Shenzhen Tenda Technology Co., Ltd. Other brand and product names mentioned herein are trademarks or registered trademarks of their respective holders. Copyright of the whole product as integration, including its accessories and software, belongs to Shenzhen Tenda Technology Co., Ltd. No part of this publication can be reproduced, transmitted, transcribed, stored in a retrieval system, or translated into any language in any form or by any means without the prior written permission of Shenzhen Tenda Technology Co., Ltd.

## Disclaimer

Pictures, images and product specifications herein are for references only. To improve internal design, operational function, and/or reliability, Tenda reserves the right to make changes to the products without obligation to notify any person or organization of such revisions or changes. Tenda does not assume any liability that may occur due to the use or application of the product described herein. Every effort has been made in the preparation of this document to ensure accuracy of the contents, but all statements, information and recommendations in this document do not constitute a warranty of any kind, express or implied.

# Preface

Thank you for choosing Tenda! Please read this guide before you manage the Network Video Recorder (NVR).

## Applicable models

This user guide is applicable to all single NVR products, HD Video Security Kits and PoE HD Video Security Kits.

Unless otherwise specified, the N3L-4H single NVR product, and the K4P-4TR video security kit (NVR model: N6P-4H, camera model: IT7-PRS-K) are used for illustration.





The video security kit includes an NVR and multiple cameras. The NVR supports configuration through GUI and Web, and the camera has no configuration page.

## Conventions

The typographical elements that may be found in this document are defined as follows.

| Item                | Presentation | Example  |
|---------------------|--------------|--|
| Cascading menus     | >            | <b>Playback &gt; File</b>                              |
| Parameter and value | Bold         | Set <b>User Name</b> to <b>Tom</b> .                   |
| Variable            | Italic       | Format: <i>XX:XX:XX:XX:XX:XX</i>                       |
| UI control          | Bold         | On the <b>Policy</b> page, click the <b>OK</b> button. |
| Message             | “ ”          | The “Success” message appears.                         |

The symbols that may be found in this document are defined as follows.

| Symbol  | Meaning  |
|---|--|
|  | This format is used to highlight information of importance or special interest. Ignoring this type of note may result in ineffective configurations, loss of data or damage to the device. |
|  | This format is used to highlight a procedure that will save time or resources.   |

## For more documents

If you want to get more documents of the device, visit [www.tendacn.com](http://www.tendacn.com) and search for the corresponding product model.

The related documents are listed as below.

| Document                 | Description  |
|--------------------------|--|
| Datasheet                | It introduces the basic information of the NVR, including product overview, selling points, and specifications.  |
| Quick Installation Guide | It introduces how to set up the device quickly for internet access, the descriptions of LED indicators, ports, and buttons, FAQ, statement information, and so on. |
| App User Guide           | It introduces how to use the TDSEE app to manage the NVR.  |
| GUI and Web User Guide   | It introduces how to set up the device functions on the GUI and web for more requirements.   |

## Technical Support

If you need more help, contact us by any of the following means. We will be glad to assist you as soon as possible.



Hotline

Global: (86) 755-27657180

(China Time Zone)

United States: 1-800-570-5892

(Toll-Free: 7 x 24 hours)

Canada: 1-888-998-8966

(Toll Free: Mon - Fri 9 am - 6 pm  
PST)

Hong Kong: 00852-81931998



Email

[tendasecurity@tenda.cn](mailto:tendasecurity@tenda.cn)



Website

<https://www.tendacn.com/>

## Revision History

Tenda is constantly searching for ways to improve its products and documentation. The following table indicates any changes that might have been made since the user guide was released.

| Version | Description  | Date       |
|---------|--|------------|
| V1.2    | <ol style="list-style-type: none"><li>1. Optimized OSD configuration and image configuration function.</li><li>2. Added such functions as audio configuration, privacy shutter, shutter detection and camera auto maintenance.</li><li>3. Optimized sentence expression</li></ol>    | 2022-04-30 |
| V1.1    | <ol style="list-style-type: none"><li>1. Web management added</li><li>2. PTZ control added</li><li>3. Such network configuration functions as PoE configuration, port configuration, DDNS and UPnP are added.</li><li>4. DST added</li><li>5. Optimize sentence expression</li></ol> | 2022-01-17 |
| V1.0    | Original publication.  | 2021-12-17 |

# Contents

|   |   |    |
|---|---|----|
| 1 | Product Feature.....                      | 1  |
|   | 1.1 Basic Function .....                  | 1  |
|   | 1.2 Local Monitoring .....                | 2  |
|   | 1.3 File Management .....                 | 2  |
|   | 1.4 Recording and Playback .....          | 2  |
|   | 1.5 Backup.....                           | 3  |
|   | 1.6 Alarm and Exception Management .....  | 3  |
|   | 1.7 Other Local Function .....            | 4  |
|   | 1.8 Network Function.....                 | 4  |
| 2 | Startup and Shutdown .....                | 5  |
|   | 2.1 Startup.....                          | 5  |
|   | 2.2 Shutdown .....                        | 6  |
| 3 | Activation and Quick Setup.....           | 7  |
|   | 3.1 Local Activation and Quick Setup..... | 7  |
|   | 3.2 Web Activation .....                  | 12 |
| 4 | Local Management (GUI) .....              | 15 |
|   | 4.1 Local Login.....                      | 15 |
|   | 4.2 GUI Introduction .....                | 17 |
|   | 4.2.1 Mouse Operation .....               | 17 |
|   | 4.2.2 Layout.....                         | 18 |
|   | 4.2.3 Frequently-used Elements .....      | 19 |
|   | 4.3 General Operation.....                | 20 |
|   | 4.3.1 Logout .....                        | 20 |
|   | 4.3.2 Reboot.....                         | 20 |

|  |     |
|--|-----|
| 4.3.3 Reset Login Password .....                           | 21  |
| 4.3.4 Check Alarm Notification of Exception Detection..... | 23  |
| 4.4 Live View .....  | 24  |
| 4.4.1 Overview .....                                       | 24  |
| 4.4.2 Quick Operation .....                                | 26  |
| 4.4.3 Quickly Add a Camera .....                           | 28  |
| 4.4.4 Instant Playback .....                               | 31  |
| 4.4.5 Zoom in .....  | 33  |
| 4.4.6 Switch Window Division Mode .....                    | 34  |
| 4.4.7 PTZ Control.....                                     | 35  |
| 4.4.8 Check Stream Info .....                              | 45  |
| 4.4.9 Modify Channel Sequence .....                        | 46  |
| 4.5 Playback.....  | 47  |
| 4.5.1 Channel Playback .....                               | 47  |
| 4.5.2 File Playback.....                                   | 51  |
| 4.5.3 Add Tag.....   | 61  |
| 4.5.4 Tag Playback .....                                   | 65  |
| 4.5.5 Clip and Export the Recording File .....             | 72  |
| 4.6 Configuration.....                                     | 75  |
| 4.6.1 Show or Hide Professional Setting .....              | 75  |
| 4.6.2 Channel Management.....                              | 76  |
| 4.6.3 Storage Management.....                              | 105 |
| 4.6.4 Alarm Management .....                               | 114 |
| 4.6.5 Network Configuration.....                           | 131 |
| 4.6.6 System Configuration .....                           | 154 |
| 4.7 Maintenance .....                                      | 169 |
| 4.7.1 Devie Info .....                                     | 169 |
| 4.7.2 Channel Info .....                                   | 170 |

|  |     |
|--|-----|
| 4.7.3 Device Upgrade .....                               | 172 |
| 4.7.4 System Log .....                                   | 175 |
| 4.7.5 Diagnosis .....                                    | 181 |
| 4.7.6 Device Maintenance .....                           | 185 |
| 5 Web Management .....                                   | 188 |
| 5.1 Web Login.....                                       | 188 |
| Scenario 1: With DHCP Server in the Network .....        | 188 |
| Scenario 2: Without DHCP Server in the Network.....      | 191 |
| 5.2 Live View .....                                      | 195 |
| 5.2.1 Overview .....                                     | 195 |
| 5.2.2 Preview the Monitoring Image of Each Channel ..... | 197 |
| 5.2.3 Zoom in .....                                      | 199 |
| 5.3 Playback.....  | 201 |
| 5.3.1 Overview .....                                     | 201 |
| 5.3.2 Play Back the Specific Channel.....                | 202 |
| 5.4 Configuration.....                                   | 204 |
| 5.4.1 Channel .....                                      | 204 |
| 5.4.2 Storage Management.....                            | 204 |
| 5.4.3 Alarm Recording.....                               | 211 |
| 5.4.4 Network Configuration.....                         | 215 |
| 5.5 System Management .....                              | 216 |
| 5.5.1 Device Info.....                                   | 216 |
| 5.5.2 Device Log .....                                   | 216 |
| 5.5.3 System Configuration .....                         | 217 |
| 5.5.4 System Maintenance.....                            | 219 |
| 5.5.5 User Management .....                              | 222 |
| Appendix .....   | 223 |
| Acronyms and Abbreviations .....                         | 223 |



# 1

# Product Feature

## 1.1 Basic Function

- Connectable to cameras of multiple brands.
- Support H.265 video encoding standard, allowing simultaneous connection of the H.265 and H.264 cameras.
- Support H.264+ and H.265+ video coding standards.
- Adopt the standard ONVIF protocol.
- Support main stream and sub-stream live view for each channel.
- Support the maximum resolution of 8 MP for each channel.
- Allow independent adjustment on video coding parameters of each channel, such as the resolution, frame rate and bit rate.
- Support quick connection of cameras.
- Support the Tenda camera upgrade.
- Support such functions as smart search, playback and backup, which can effectively improve the efficiency of recording retrieval and playback.

## 1.2 Local Monitoring

- Provide VGA and HDMI high-definition resolution display output.
- Support parallel live view and playback of different channels.
- Support 1/4/8/9/16-channel image live view.
- Support adjustment of the live view channel sequence.
- Support quick settings on the live view page.
- Support multiple live view modes with customized auto-switch dwell time.
- Allow quick connection of the camera on the live view page.
- Support PTZ control, including setting and calling of preset point and patrol.

## 1.3 File Management

- Support up to 10TB hard disk drive (HDD) with the SATA interface.
- Support the local and remote HDD detection function.

## 1.4 Recording and Playback

- Support simultaneous recording of main stream and sub-stream.
- Support two recording modes: Overwrite and non-overwrite.
- Support normal recording and alarm recording.
- Support post-record of alarm recording.
- Support the setting of 8 recording periods with different recording modes every day
- Support distinguishing recording types through colors, and quick display and playback through ticking recording types.
- Support searching recording by such methods as channel number, recording type, file type, start time and end time.

- Support adding tags to play back recordings, searching and playing back according to tags.
- Support scrolling up or down the mouse to zoom in or out playback time bar.
- The playback function supports pausing, speeding up, speeding down, fast forward/backward and location by a mouse click.
- Support local zoom in any area by scrolling up or down the mouse during single-channel playback.

## **1.5 Backup**

- Support backup through a USB port.
- Support batch and clip backup during playback.
- Support system log backup.

## **1.6 Alarm and Exception Management**

- Alarm for such types as motion detection, human detection, tempering detection, channel error, unauthorized access, internet interruption, IP address conflict, no HDD, HDD error and insufficient HDD space.
- Alarms will trigger such actions as single-screen display, app alarm notification, alarm email, and any channel recording.
- Support firmware watchdog. The system can be automatically rebooted when it runs abnormally.

## 1.7 Other Local Function

- The administrator is allowed to create multiple users and set their permissions. The permissions can be restricted to the channel.
- Support quick retrieval of multiple types of logs, including information, exception, operation, configuration and alarm.

## 1.8 Network Function

- Provide one self-adaptive 10/100 Mbps Ethernet uplink port.
- Support TCP and IP protocol clusters, such as HTTP, HTTPS, WebSockets, TCP/IP, IPv4, RTSP, UDP, NTP, DHCP, DNS, DDNS.
- Support the standard ONVIF protocol.
- Support web management, including preview monitoring, video playback, PTZ control, alarm settings and system management.
- Support remote web management.
- Support the browser without plug-in: Chrome, Edge and Opera.

# 2 Startup and Shutdown

## 2.1 Startup



Use the included power adapter to power on the NVR. An abnormal power supply will cause running failure or even damage to the NVR.

Power on the NVR to start it using the included power adapter.

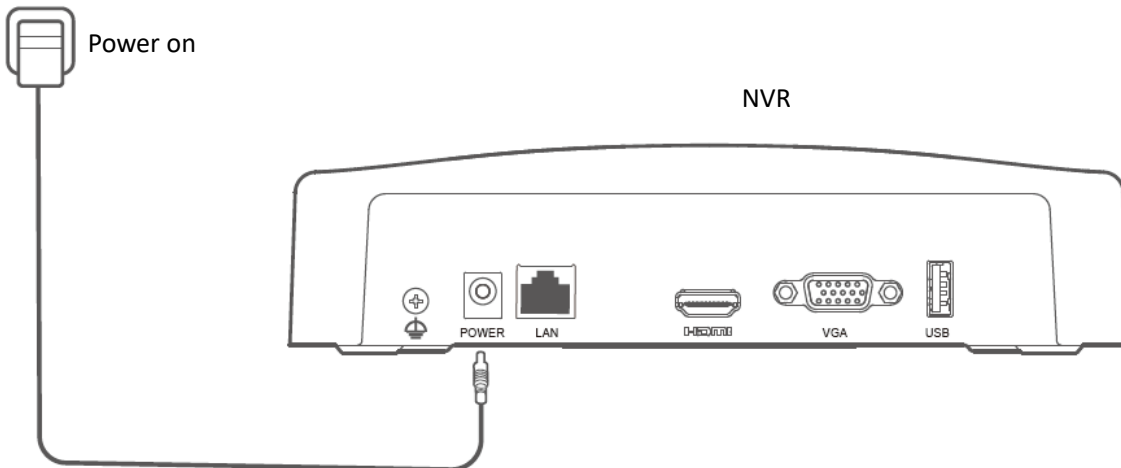



## 2.2 Shutdown



Do not directly cut off the power of the NVR to force a shutdown; otherwise, the HDD may be damaged, causing video loss and even damage to the NVR.

**Step 1** Connect the mouse and monitor to the NVR.

**Step 2** Click  in the upper-right corner on the GUI of the NVR (to exit the full-screen interface), click **Shutdown** , and then click **OK**.

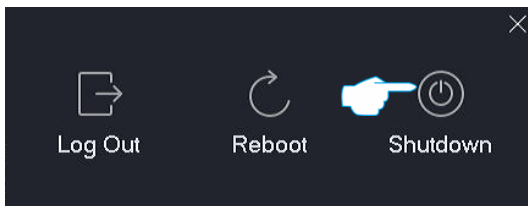

**Step 3** When “The Device is Shutdown. Please Cut Off the Power” appears on the screen, unplug the power adapter of the NVR.



**---End**

# 3 Activation and Quick Setup

## Setup

You can activate the NVR upon the first use or after resetting the NVR. Tenda NVR supports local activation and web activation.

- Local activation: After the activation is completed, you can enter the quick setup page to quickly set up the monitoring network.
- Web activation: After the activation is completed, you need to log in again.

### 3.1 Local Activation and Quick Setup

**Step 1** Power on the NVR, connect the monitor to the VGA port or HDMI port of the NVR using a VGA/HDMI cable, then connect the mouse to the USB port of the NVR.

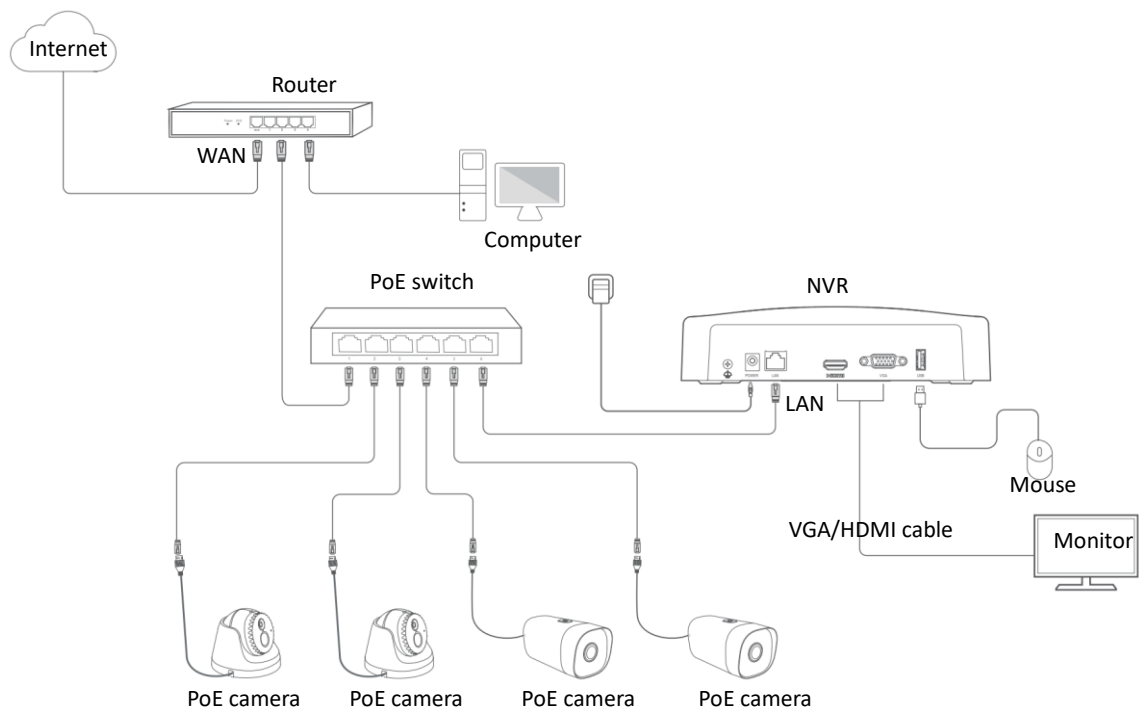

**Step 2** Set login **Password** and **Confirm Password**, enter your **Email Address**, and then click **Activate**.

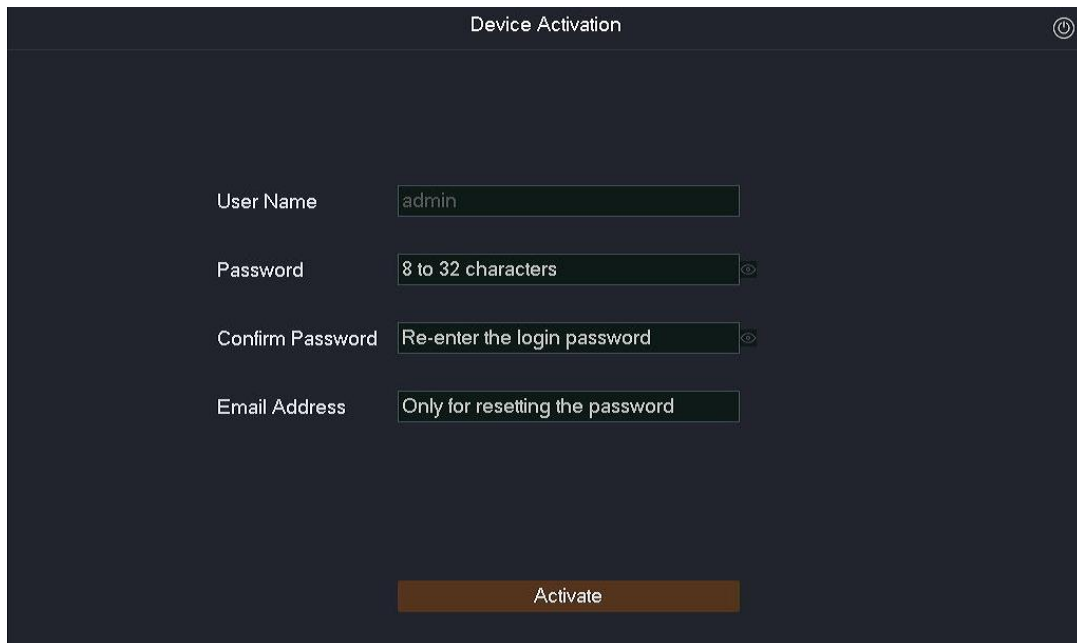

The screenshot shows a 'Device Activation' window with a dark background. At the top, the title 'Device Activation' and a power icon are visible. Below the title, there are four input fields: 'User Name' with the text 'admin', 'Password' with the placeholder '8 to 32 characters', 'Confirm Password' with the placeholder 'Re-enter the login password', and 'Email Address' with the placeholder 'Only for resetting the password'. At the bottom center, there is a brown 'Activate' button.

**Step 3** If you want to use a pattern to unlock the GUI, please draw an unlock pattern. Otherwise, click **Do Not Use Unlock Pattern** and go to **Step 4**.

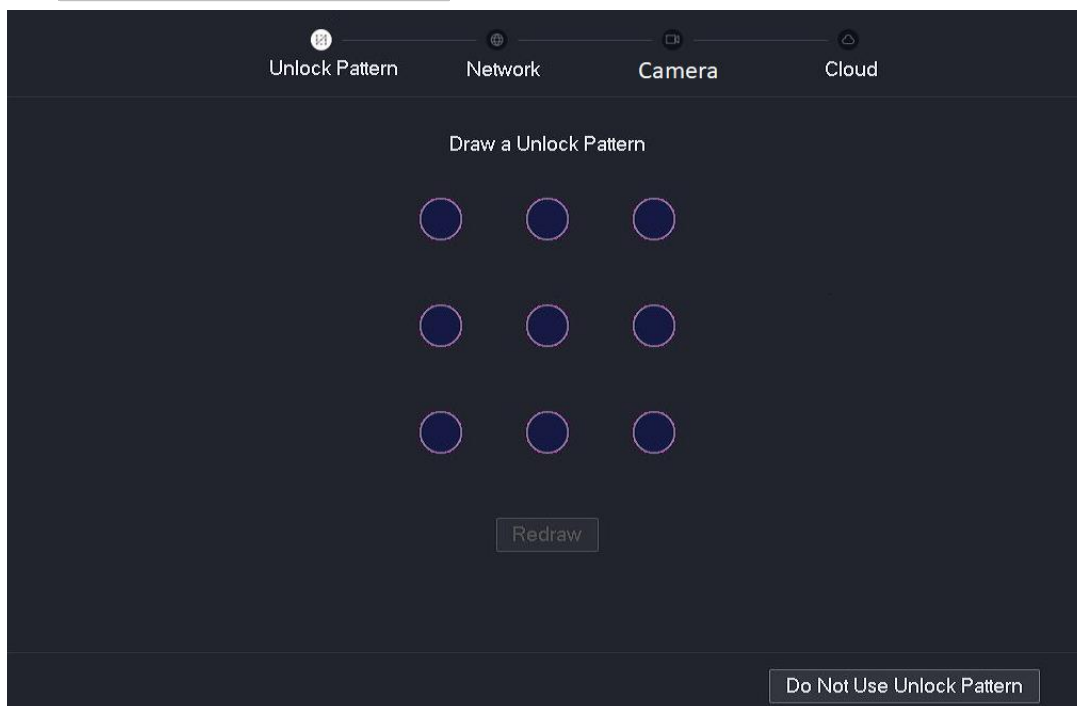

The screenshot shows a screen for drawing an unlock pattern. At the top, there are four tabs: 'Unlock Pattern' (selected), 'Network', 'Camera', and 'Cloud'. Below the tabs, the text 'Draw a Unlock Pattern' is centered. In the center of the screen, there is a 3x3 grid of nine blue circles. Below the grid, there is a 'Redraw' button. At the bottom right, there is a 'Do Not Use Unlock Pattern' button.



**Step 4** Ensure that the connection status is **Connected**, and enable the **Auto add LAN cameras** function as required.

- If you want to automatically add the camera on the LAN port of the NVR, click **Next**, and go to [Step 6](#).
- If you want to manually add the camera on the LAN port of the NVR, disable the **Auto add LAN cameras** function, then click **Next**.



If the connection status is **Disconnected**, try the following solutions:

- Ensure that the LAN port of the NVR is connected properly.
- Ensure that the router to which the NVR is connected has enabled the DHCP server function.

The screenshot displays the 'Network' configuration page of an NVR. At the top, there are three tabs: 'Unlock Pattern', 'Network' (which is selected), and 'Cloud'. Below the tabs, the 'Connection Status' is shown as 'Connected' in green text. The 'Auto add LAN cameras' and 'DHCP' options are both enabled, indicated by orange toggle switches. The 'IP Address' field contains '192 · 168 · 0 · 188', the 'Subnet Mask' field contains '255 · 255 · 255 · 0', and the 'Default Gateway' field contains '192 · 168 · 0 · 1'. At the bottom right, there are two buttons: 'Previous' and 'Next'.

**Step 5** Add the camera.

Select the camera you want to add in the **Online Camera** list, and click **Add**. Wait until the camera appears in the **Added Camera** list and the status is **Online**, and click **Next**.



- Ensure that the IP address of the camera to be added and the IP address of the NVR is in the same network segment.
- If the user name and password of the camera to be added are different from the NVR, click , fill in the related information, and then click **Add**.

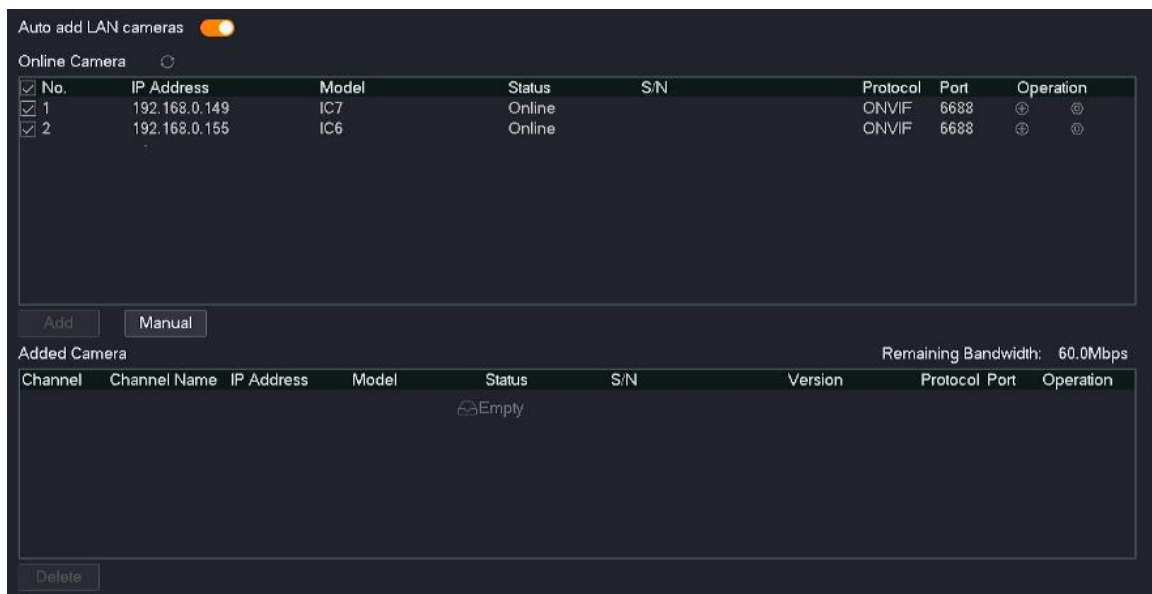

**Step 6** Ensure that the cloud status is **Online** and click **OK**.



- If the cloud status is **Offline**, ensure that the router to which the NVR is connected can access the internet and the filter function is disabled.
- You can also manage the NVR through the **TDSEE** app. Please refer to [Manage the NVR through TDSEE App](#) for details.

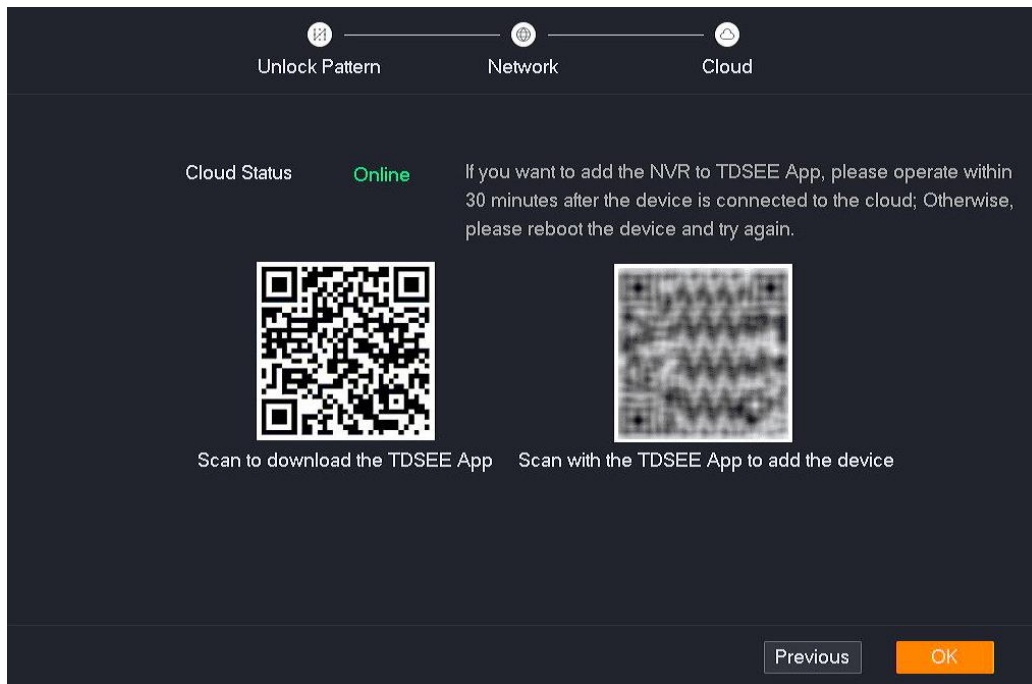

---End

After the activation is completed, you can preview real-time videos, play back the recordings and manage monitoring devices.

## 3.2 Web Activation

**Step 1** Connect the computer to the switch or router that is connected to the NVR.

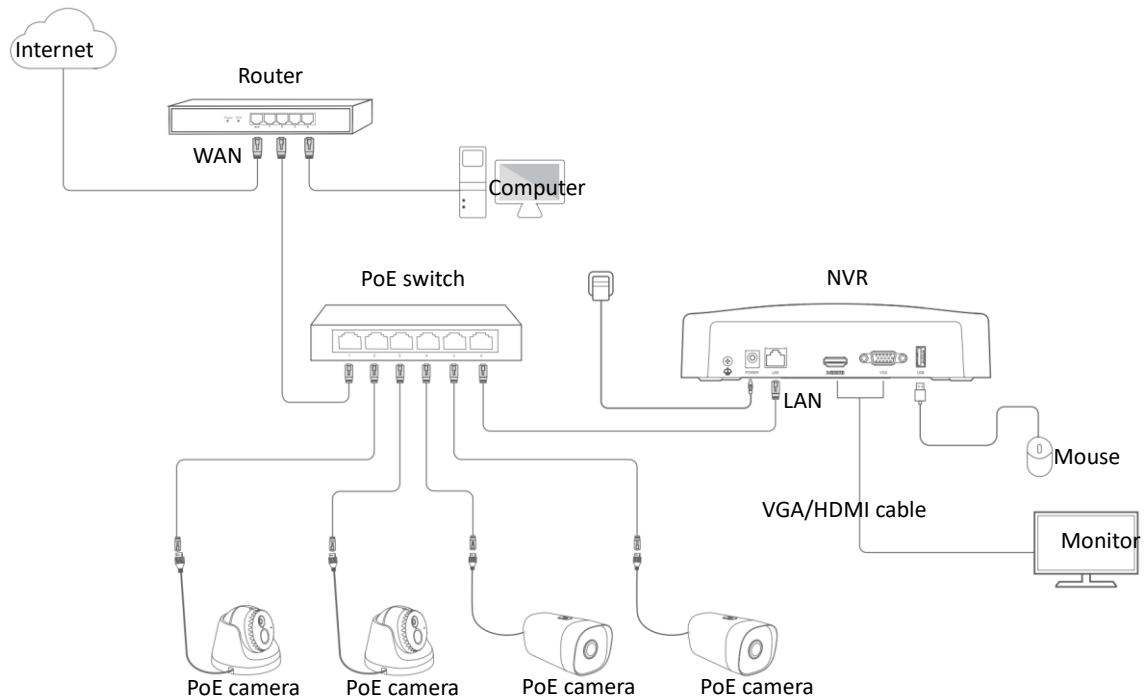

**Step 2** Set the IP address of the computer to 192.168.1.X (X indicates 2 to 253, and is unused by other devices.)

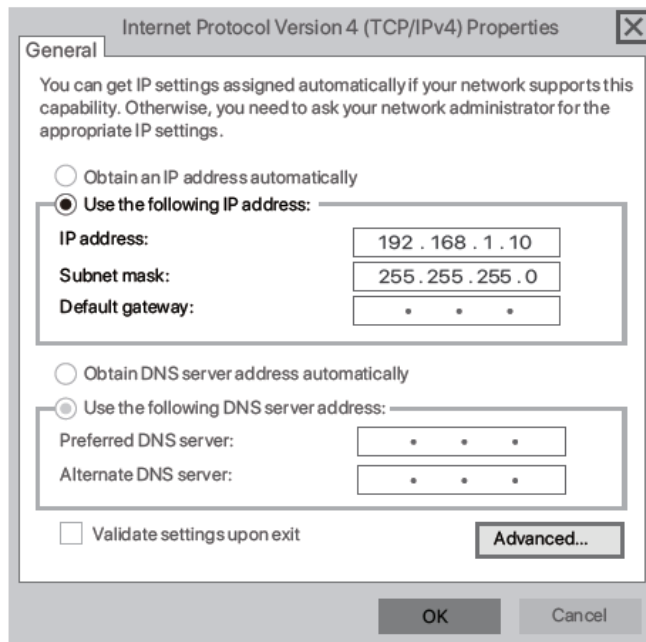

**Step 3** Start a web browser on the computer, enter the IP address of the NVR (default: 192.168.1.254) in the address bar, and press **Enter**.

The NVR supports HTTPS secure login. When you access the web UI of the NVR, the browser may prompt that the address is not safe, just continue. For example, in Google Chrome, click **Advanced** and then click **Proceed to 192.168.1.254 (unsafe)**.

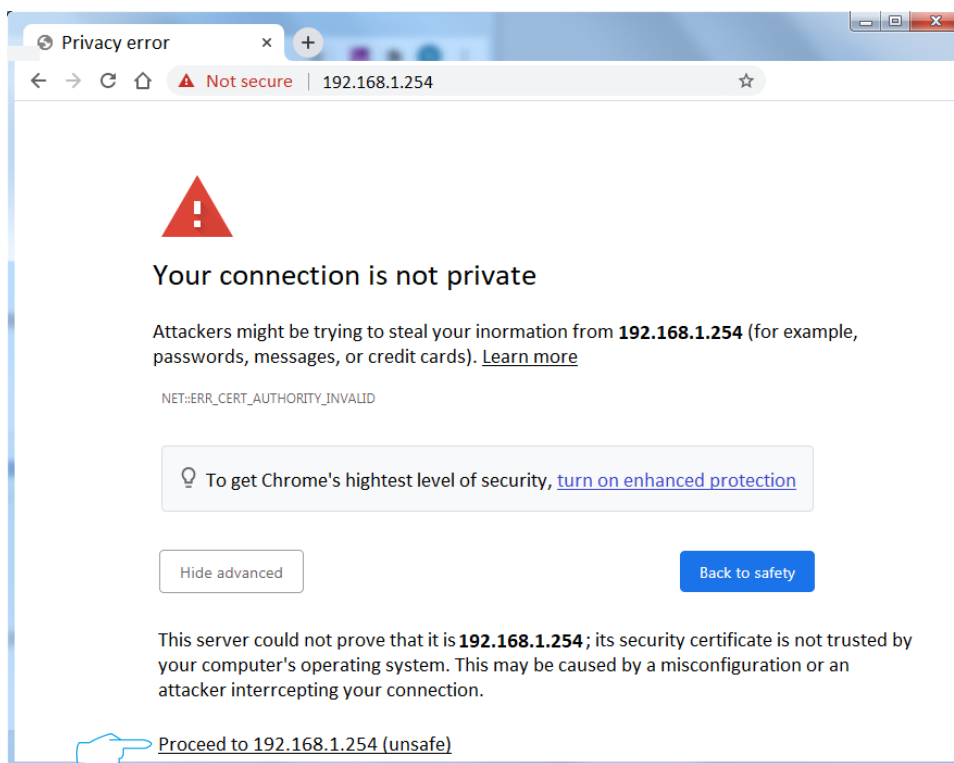
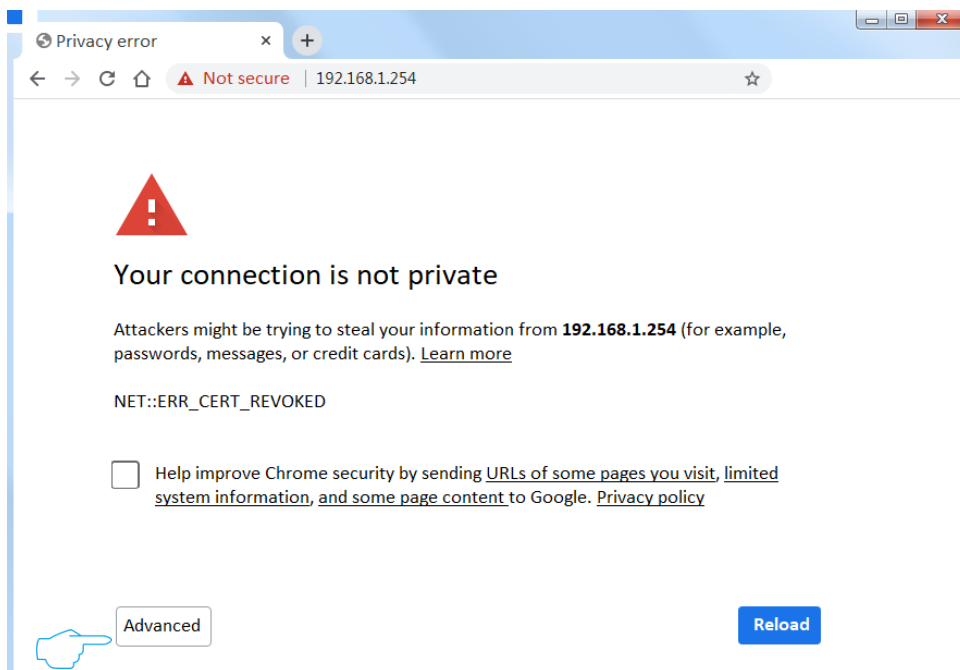

**Step 4** Set the login **Password** and **Confirm Password**, enter your **Email Address**, and click **Activate**.

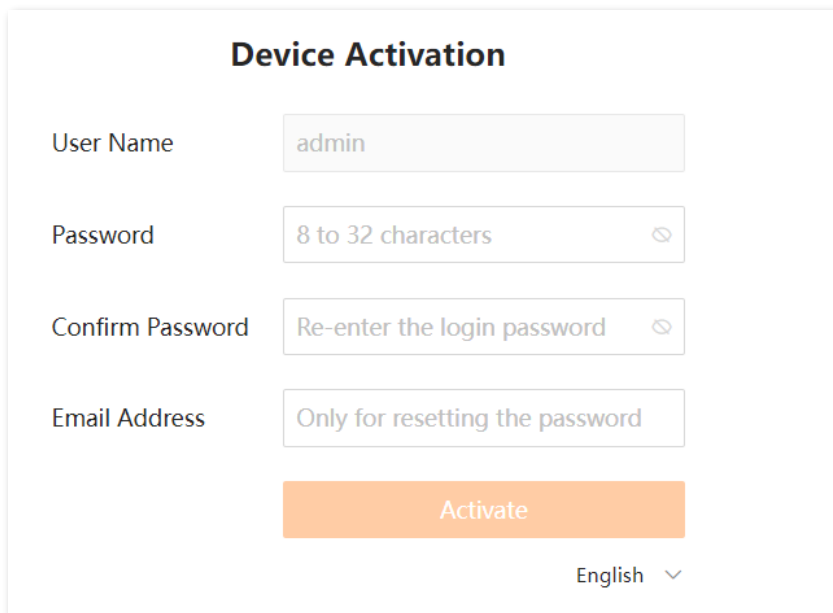

The image shows a 'Device Activation' form with the following fields and elements:

- User Name:** A text input field containing the value 'admin'.
- Password:** A text input field with a placeholder '8 to 32 characters' and a toggle icon on the right.
- Confirm Password:** A text input field with a placeholder 'Re-enter the login password' and a toggle icon on the right.
- Email Address:** A text input field with a placeholder 'Only for resetting the password'.
- Activate:** An orange button with the text 'Activate'.
- Language:** A dropdown menu showing 'English' with a downward arrow.

---End

After the activation is completed, if you want to enter the web UI, you need to log in again. Please refer to [Web Login](#) for details.

# 4

# Local Management (GUI)

## 4.1 Local Login

**Step 1** Ensure that the NVR is powered on and working properly, connect the VGA port or HDMI port of the monitor to the VGA port or HDMI port of the NVR using a VGA/HDMI cable, then connect the mouse to the USB port of the NVR.

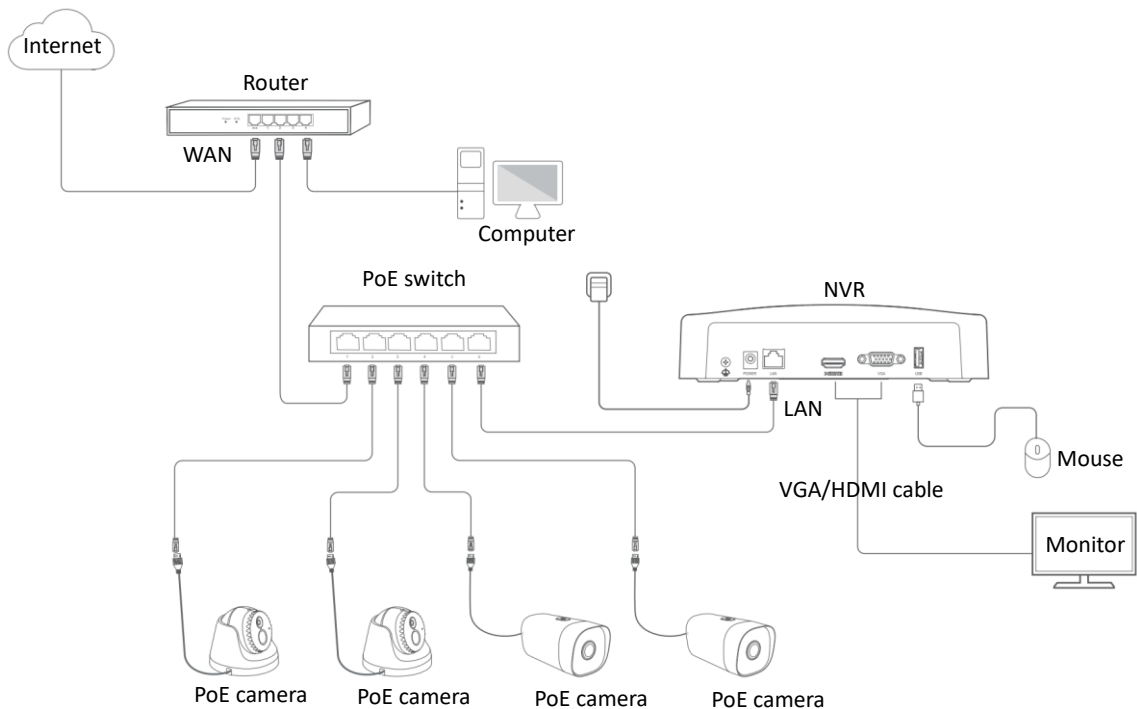

**Step 2** Draw an unlock pattern on the monitor or enter the login password to access the GUI.

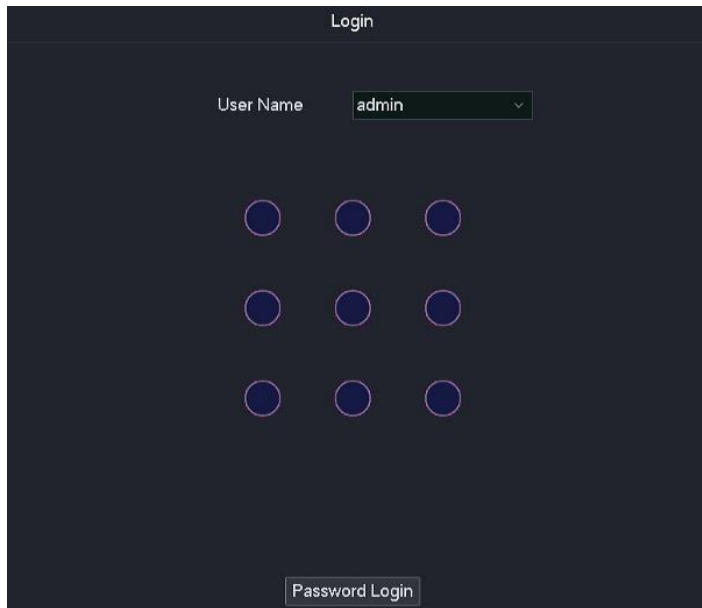

**---End**

Logged in to the GUI successfully. You can perform settings as required.



## 4.2 GUI Introduction

### 4.2.1 Mouse Operation

You can perform settings of the device with the mouse after the mouse is connected to the device. The following table describes the main operations of the mouse.

| Operation          | Description  |
|--------------------|--|
| Single left-click  | <ul style="list-style-type: none"><li>- Select a target.</li><li>- Confirm content.</li></ul>  |
| Double left-click  | <ul style="list-style-type: none"><li>- Switch between single-screen and multi-screen under live view status.</li><li>- Play back the recording file.</li></ul>  |
| Left drag          | <p>Hold the left key of the mouse and drag the mouse.</p> <ul style="list-style-type: none"><li>- Draw an unlock pattern.</li><li>- Draw an area range.</li><li>- Adjust the channel sequence on the live view page.</li></ul> |
| Single right-click | <ul style="list-style-type: none"><li>- Display the quick settings menu.</li><li>- Exit full-screen playback.</li></ul>  |
| Scroll-mouse up    | <ul style="list-style-type: none"><li>- Zoom in the target area.</li><li>- Select folded drop-down list options.</li><li>- Increase volume.</li></ul>  |
| Scroll-mouse down  | <ul style="list-style-type: none"><li>- Zoom out the target area.</li><li>- Select folded drop-down list options.</li><li>- Decrease volume.</li></ul>   |

## 4.2.2 Layout

The GUI of the NVR consists of two sections, including the navigation bar and the configuration area. See the following figure.

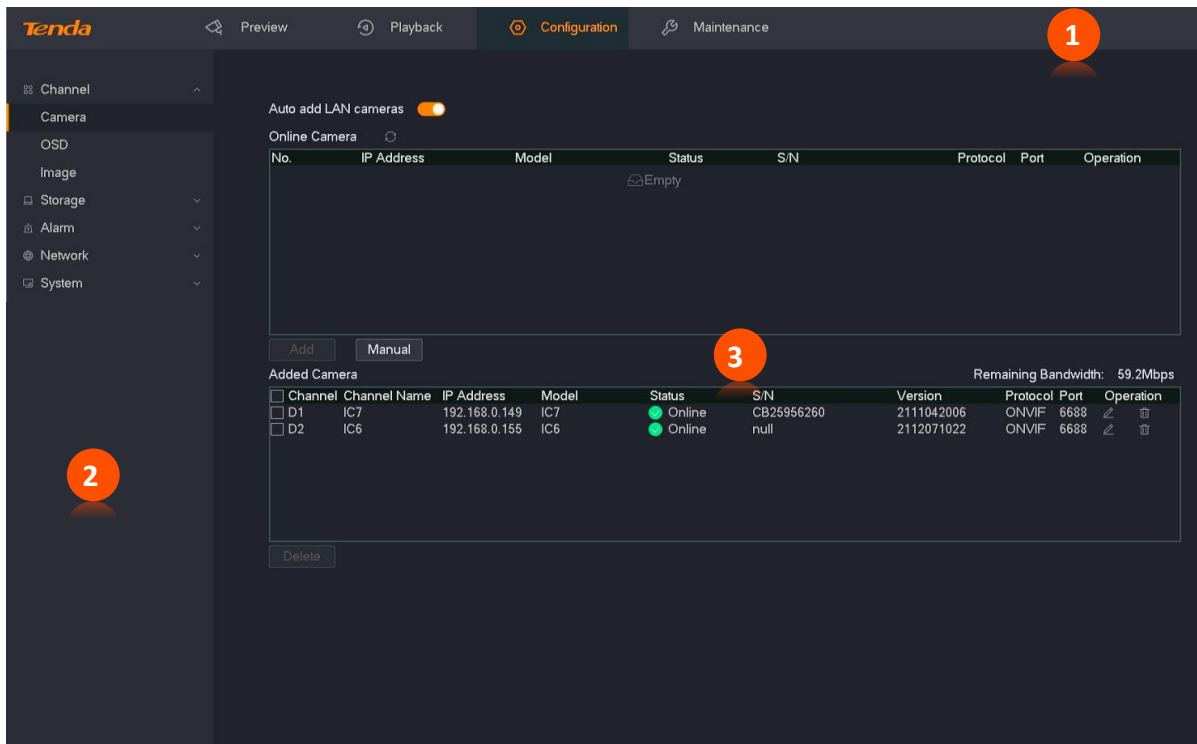

Features and parameters in gray indicate that they are not available or cannot be changed under the current configuration.

| NO. | Name               | Description   |
|-----|--------------------|---|
| 1   | Navigation bar     | They are used to display the function menu of the NVR. Users can select functions in the navigation bar and then the configuration appears in the configuration area. |
| 2   |                    |   |
| 3   | Configuration area | It is used to view or modify your configuration.  |

### 4.2.3 Frequently-used Elements

The following table describes the frequently-used buttons available on the GUI of the NVR.

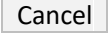
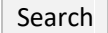

| Button  | Description   |
|---|---|
|  | It is used to save the configuration on the current page and enable the configuration to take effect. |
|  | It is used to cancel the changes you did before.  |
|  | It is used to search for the matched contents.  |

## 4.3 General Operation

### 4.3.1 Logout

The system will exit from the current operation menu to the live view screen after you log out. When you re-enter the settings page, the user name and password need to be verified.

**Step 1** Connect the mouse and monitor to the NVR.

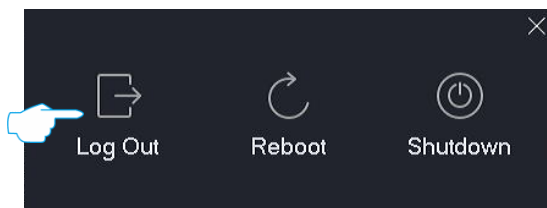

**Step 2** Click  in the upper right corner on the GUI of the NVR (to exit the full-screen interface), click **Log Out** , and then click **OK**.



---End

### 4.3.2 Reboot

**Step 1** Connect the mouse and monitor to the NVR.

**Step 2** Click  in the upper right corner on the GUI of the NVR (to exit the full-screen interface), click **Reboot** , and then click **OK**.

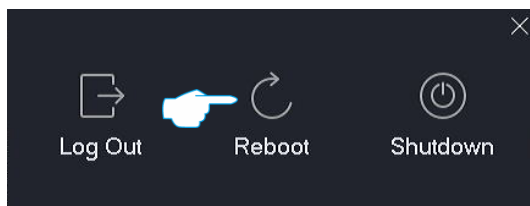

---End

### 4.3.3 Reset Login Password

If you forgot your login password, you can reset it.



You are recommended to reset your password through TDSEE App. If you did not reserve an email address when activating the NVR, you are recommended to add an email address to the administrator account on the [User Management](#) page.

**Step 1** Click **Forgot Password?** on the login page.

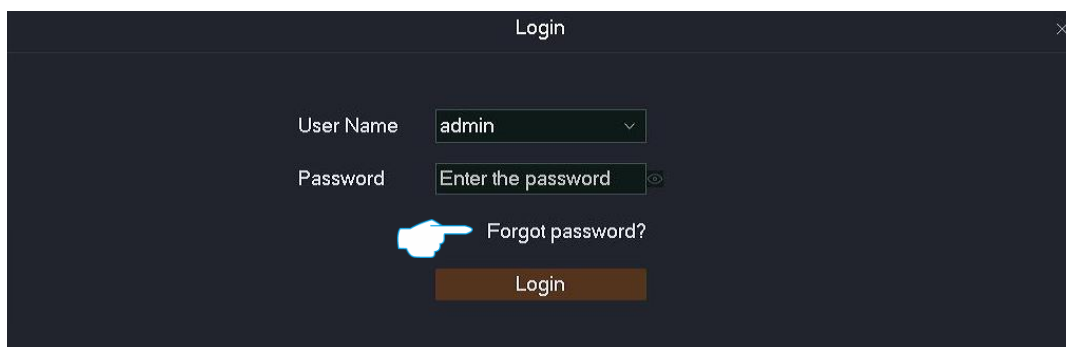

**Step 2** Follow the on-screen instructions to obtain and enter the verification code, and click **Reset**.

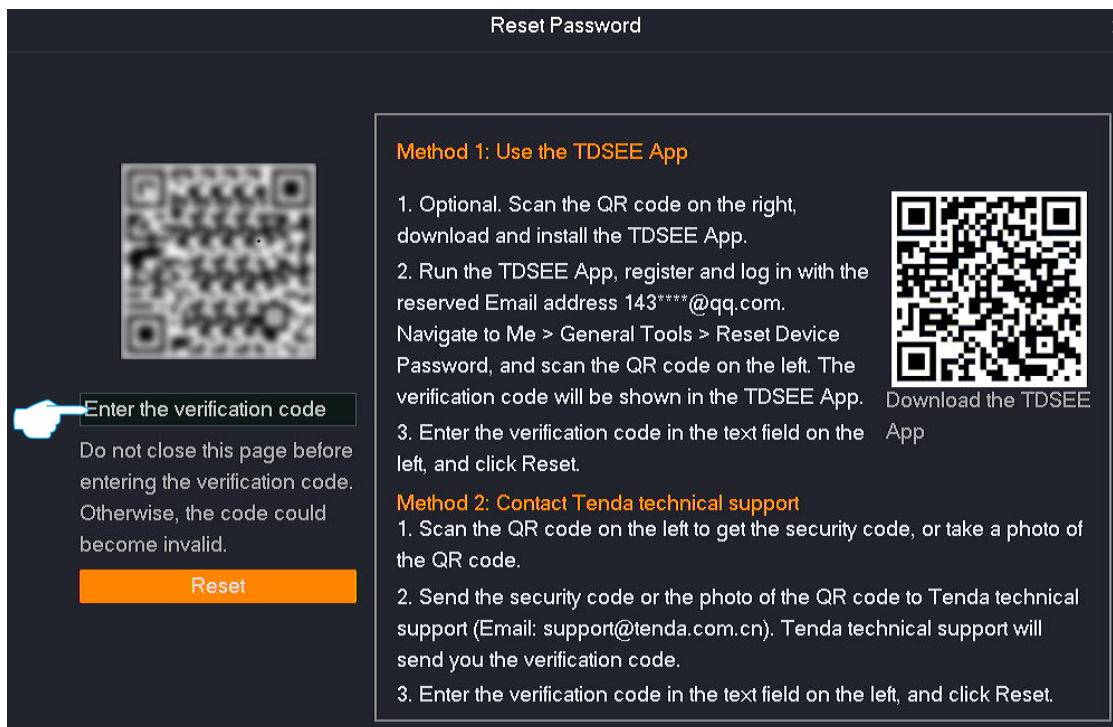

**Step 3** Follow the on-screen instructions to set a new login password, and click **Save**.

The screenshot shows a 'Reset Password' dialog box with the following fields and options:

- User Name: admin
- New Password: 8 to 32 characters
- Confirm Password: Re-enter the login password
- Sync Password to Cameras:
- Unlock Pattern:

Buttons: Cancel, Save

**---End**

## 4.3.4 Check Alarm Notification of Exception Detection



If you want to check the exception alarm notification, you can click the alarm icon  in the upper-right corner of the GUI (a red dot on the upper right of the icon indicates that there is a new alarm). Please configure the linkage mode of the related exception type as **Pop-up Window** on the [Exception Detection](#) page first.

After you click the alarm icon  on the upper-right corner of the GUI, the following figure appears.

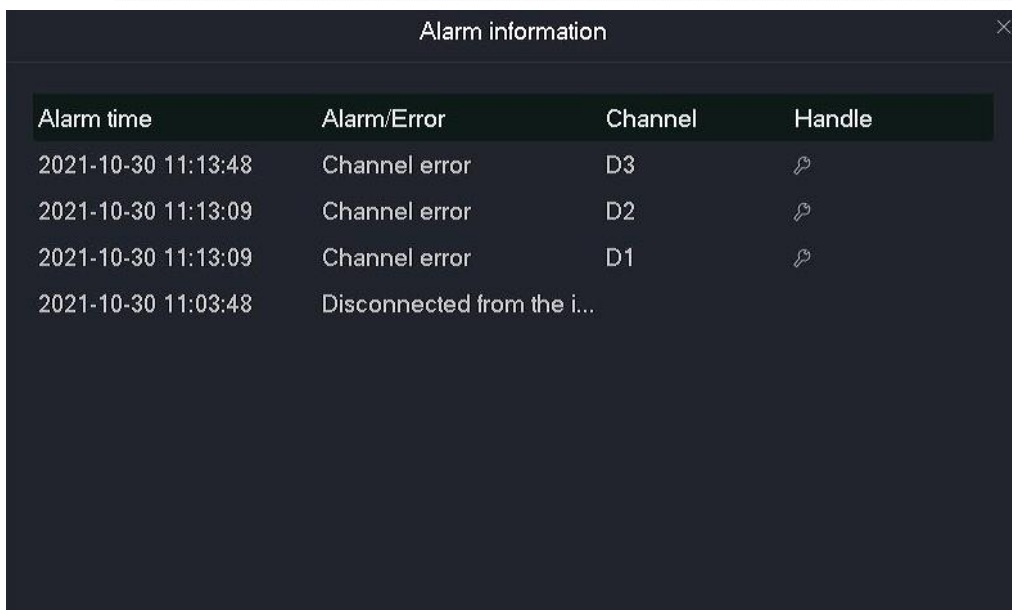

If the content of the **Channel** parameter is empty, it indicates that the alarm notification does not involve the channel. If the content of the **Handle** parameter is empty, it indicates that the alarm notification does not support handling here, or the problem no longer exists.



| Alarm time          | Alarm/Error                | Channel | Handle  |
|---------------------|----------------------------|---------|---|
| 2021-10-30 11:13:48 | Channel error              | D3      |  |
| 2021-10-30 11:13:09 | Channel error              | D2      |  |
| 2021-10-30 11:13:09 | Channel error              | D1      |  |
| 2021-10-30 11:03:48 | Disconnected from the i... |         |   |

### Parameter description

| Parameter   | Description   |
|-------------|---|
| Alarm time  | It specifies the time when an alarm event occurs.   |
| Alarm/Error | It specifies the alarm type.  |
| Channel     | It specifies the channel of triggering an alarm.  |
| Handle      | Click  to redirect to the corresponding page to handle the exceptions. |

## 4.4 Live View

### 4.4.1 Overview

Click **Live View** to enter the page.





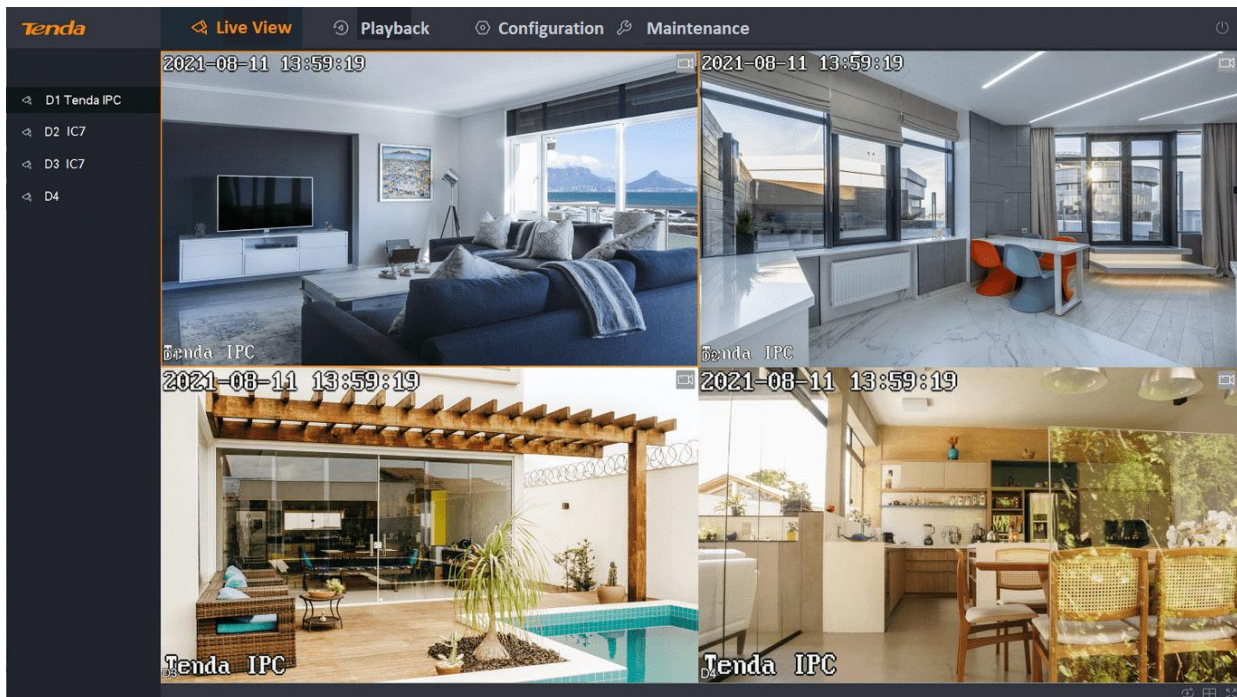





The default page is the live view page after you enter the GUI of the NVR. The number of window divisions of devices varies with different models. The actual model prevails. In this section, you can:





- Check Monitoring Image of All Channels
- [Quickly Add a Camera](#)
- [Instantly Play Back](#)
- [Zoom in Target Area](#)
- [Switch Window Division Mode](#)
- [Perform PTZ Control](#)
- [Check Stream Info](#)
- [Modify Channel Sequence](#)



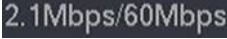
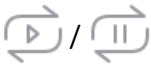

## Parameter description

| Parameter   | Description   |
|---|---|
|    | <p>Instant playback.</p> <p>It is used to play back the recordings of the channel 5 minutes before the current time.</p>  |
|    | <p>Audio switch. On the bottom of the channel. By default, it is mute.</p> <p>You can turn on, turn off or adjust the volume of the audio.</p>  |
|    | <p>PTZ control. Only cameras that support PTZ can be edited.</p> <p>It is used to perform such related operations as adjusting the monitoring direction and speed and setting preset for the PTZ camera. Please refer to <a href="#">PTZ Control</a> for more details.</p>                |
|    | <p>Stream info.</p> <p>Click it to check the current stream info, including stream type, resolution, frame rate and bitrate.</p>  |
|   | <p>On the upper-right corner of the channel.</p> <p>It specifies the audio of the video is enabled.</p>   |
|  | <p>Human detection alarm.</p> <p>Once the human detection function is enabled, if the camera detects a human, this icon will be shown on the upper-right of the channel monitoring image.</p>   |
|  | <p>Motion detection alarm.</p> <p>Once the motion detection function is enabled, if the camera detects that the moving range of the target reaches the threshold corresponding to the preset sensitivity, this icon will be shown on the upper-right of the channel monitoring image.</p> |
|  | <p>Tempering detection alarm.</p> <p>Once the tempering detection function is enabled, if the camera detects that the degree of tempering reaches the threshold corresponding to the preset sensitivity, this icon will be shown on the upper-right of the channel monitoring image.</p>  |
|  | <p>Recording.</p> <p>When the channel is recording, this icon will be shown on the upper-right of the channel monitoring image.</p>   |
|  | <p>Previous Screen.</p> <p>Switch to the previous screen.</p>   |

| Parameter   | Description  |
|---|--|
|    | Next Screen.<br>Switch to the next screen.   |
|    | On the lower-left of the page.<br>It specifies the usage of input bandwidth.   |
|    | Start or stop auto-switch live view.<br>The system displays preview images in cycles from left to right and up to down according to the channel position. The auto-switch dwell time is 5 seconds by default, and you can modify it on the <a href="#">Live View Configuration</a> page. |
|    | Live view division mode.<br>It specifies that the number of windows varies with the division modes.  |
|    | Fullscreen.<br>It specifies that the live view page is displayed on full screen.   |
|   | It is used to add a camera.  |
|  | It specifies the current user account does not have the live view permission for this channel.   |

## 4.4.2 Quick Operation

Right-click the mouse on the live view page to perform a quick operation, such as window division, auto-switch, adding the camera, playback and fullscreen.

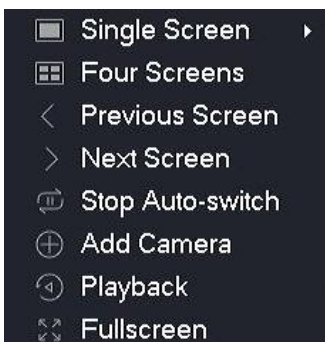

### Parameter description

| Parameter     | Description                                  |
|---------------|--|
| Single Screen | It is used to display single-channel images. |

| <b>Parameter</b>                      | <b>Description</b>  |
|---------------------------------------|---|
| Four Screens                          | It is used to display four-channel images.  |
| Multiple Screens                      | It is used to display multiple channel images. Available in NVRs with more than 4 channels. |
| Previous Screen<br>Next Screen.       | They are used to switch to the previous or next screen.                                     |
| Start Auto-switch<br>Stop Auto-switch | They are used to start or stop the auto switch of the camera monitoring image.              |
| Add Camera                            | Click it to enter the page for adding cameras.  |
| Playback                              | Click it to enter the playback page.  |
| Fullscreen<br>Exit Fullscreen         | They are used to display the live view page in fullscreen or exit fullscreen.               |

### 4.4.3 Quickly Add a Camera



- If you want to add other brand cameras, please connect the camera to the LAN where the NVR is located using an Ethernet cable.
- When adding cameras in the kit, please ensure that the cameras are in the factory settings. If not, please reset the cameras first.
- The camera in the wireless video security kit can be discovered and added automatically within 2 minutes after the NVR is started. After the NVR is working properly, the camera can be discovered automatically, but you need to add it manually.
- In the PoE video security kit, if the camera is connected to the PoE port of the NVR, the camera will be discovered and added by the system within 2 minutes.
- The number of cameras that can be added varies with the NVR models. Please add a camera according to the actual situation.

#### Method 1

**Step 1** Connect the camera to the LAN where the NVR is located. If the Wi-Fi camera is included in the video security kit, place the camera within the coverage range of the NVR.

**Step 2** Click **Live View**, right-click and select **Add Camera**.

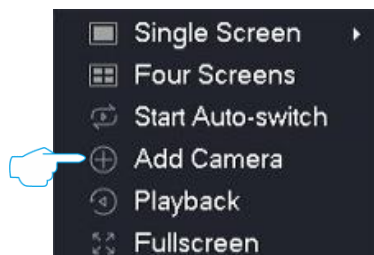

**Step 3** Add the camera on the **Online Camera** module.

Method 1: Locate the camera you want to add according to the serial number (S/N), tick the box before it, and click **Add**.



If the user name and password of the camera to be added are different from those of the NVR, please add the camera by [Method 2](#).



Method 2:

1. Locate the camera you want to add according to the S/N, and click  behind the camera.



2. Select the protocol of the camera, enter the port, username and password, and click **Add**.

| Field         | Value                    |
|---------------|--------------------------|
| IP Address    | 192 . 168 . 0 . 0        |
| Protocol      | Tenda                    |
| Port          | 8000                     |
| User Name     | admin                    |
| Password      |                          |
| Use NVR Pa... | <input type="checkbox"/> |

3. If you want to add other cameras, repeat substep 1 and substep 2.

---End

Wait a moment. The camera is added successfully. You can check the added camera in the **Added Camera** module.

| Channel                     | Channel Name | IP Address    | Model        | Status   | S/N        | Version    | Protocol | Port | Operation |
|-----------------------------|--------------|---------------|--------------|----------|------------|------------|----------|------|-----------|
| <input type="checkbox"/> D1 | IC7          | 192.168.0.149 | IC7          | ● Online | CB25956260 | 2111042006 | ONVIF    | 6688 |           |
| <input type="checkbox"/> D3 |              | 192.168.0.140 | TD-L33DS1201 | ● Online | PC50739472 | 2111220953 | ONVIF    | 6688 |           |

## Method 2



This method is not available in the PoE video security kit series products.

- Step 1** Connect the camera to the LAN where the NVR is located. Place the Wi-Fi camera in the video security kit within the coverage range of the NVR.
- Step 2** Click **Live View**.
- Step 3** In the **New Camera Found** pop-up window, you can find the camera you want to add, and then click in order or click **Add All** directly.

| No. | IP Address    | Status    | Operation |
|-----|---------------|-----------|-----------|
| 1   | 192.168.0.117 | Not added |           |
| 2   | 192.168.0.149 | Not added |           |

---End

Wait a moment until the camera is added successfully. You can view the added cameras in the **Added Camera** module on the **Configuration > Channel > Camera** page.

| Added Camera             |         |              |               |              |        |            |            |          |      | Remaining Bandwidth: 59.0Mbps |  |
|--------------------------|---------|--------------|---------------|--------------|--------|------------|------------|----------|------|-------------------------------|--|
| <input type="checkbox"/> | Channel | Channel Name | IP Address    | Model        | Status | S/N        | Version    | Protocol | Port | Operation                     |  |
| <input type="checkbox"/> | D1      | IC7          | 192.168.0.149 | IC7          | Online | CB25956260 | 2111042006 | ONVIF    | 6688 |                               |  |
| <input type="checkbox"/> | D3      |              | 192.168.0.140 | TD-L33DS1201 | Online | PC50739472 | 2111220953 | ONVIF    | 6688 |                               |  |

Delete

### 4.4.4 Instant Playback

Instant Playback enables you to view the recording files of the channel 5 minutes before the current time.



During instant playing back, other operations are not available on the live view page.

#### Procedure:

**Step 1** [Log in to the GUI of the NVR.](#)

**Step 2** Click **Live View**, hover the mouse over the channel you want to play back, and click  on the bottom of the channel.



**Step 3** You can pause or play, control the playback time and exit as required.

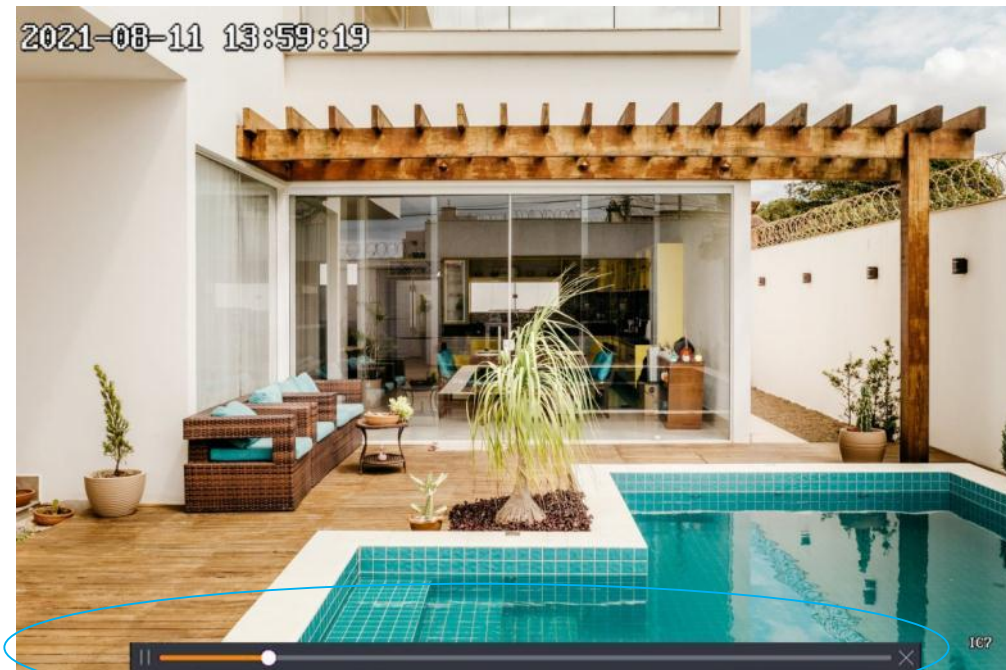

---End



## 4.4.5 Zoom in

The zoom-in function enables you to zoom in the target area of the monitoring image to view the detailed image.

**Procedure:**

- Step 1** [Log in to the GUI of the NVR.](#)
- Step 2** Click **Live View**.
- Step 3** Right-click the channel and select single screen or double-click the channel image to display the channel you want to zoom in.
- Step 4** Scroll up or down the mouse to zoom in on the target area, and you can view the details of the area. Left-click to cancel the zoom-in.

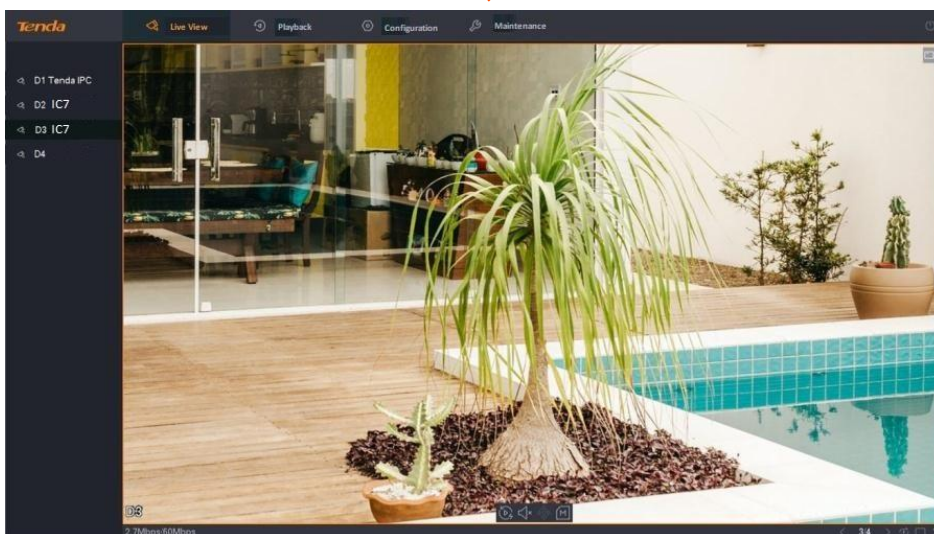

---End

## 4.4.6 Switch Window Division Mode

Different window division modes correspond to different numbers of window divisions. Tenda NVR supports single-screen and window divisions.

### Method 1

**Step 1** [Log in to the GUI of the NVR.](#)

**Step 2** Click **Live View**.

**Step 3** Right-click to select **Single Screen** and the channel to be displayed on the single-screen, or select **Four Screens** (For the NVR with more than 4 channels, please select window division and window division mode.).

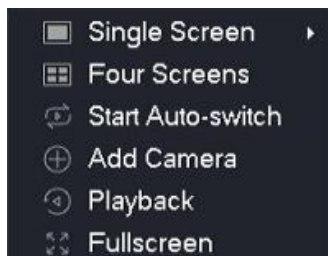

---End

### Method 2

Live view with four screens is used for illustration here.

**Step 1** [Log in to the GUI of the NVR.](#)

**Step 2** Click **Live View**.

**Step 3** Click **Window Division** (  ) in the lower-right corner, then choose the window division mode as required.

---End

## 4.4.7 PTZ Control





### Overview











PTZ indicates that a mechanical platform is composed of motors, which can move horizontally and vertically. Through the control system, the direction and speed of the PTZ camera or speed dome camera can be remotely controlled.

On the live view page, you can control the PTZ camera or speed dome camera, including adjusting the monitoring direction and speed and setting the patrol.



### Parameter & Button description

| Parameter   | Description   |
|---|---|
|  | <p>It is used to control the PTZ direction, including:</p> <ul style="list-style-type: none"><li>– Direction (up, down, left, right, upper left, lower left, upper right and lower right) of the PTZ and speed dome camera.</li><li>– Horizontal 360° automatic patrol (  ) of the PTZ camera or speed dome camera.</li></ul> |
|  | <p>It is used to reduce the multiple of the focal length change of the zoom lens. After you click it, the lens zooms out and the scene becomes smaller.</p>   |
|  | <p>It is used to increase the multiple of the focal length change of the zoom lens. After you click it, the lens zooms in and the scene becomes clearer.</p>  |

| Parameter   | Description  |
|---|--|
|  | It is used to reduce the focal length of the zoom lens. After you click it, the distant scene becomes clear, and the nearby scene gradually blurs.   |
|  | It is used to increase the focal length of the zoom lens. After you click it, the nearby scene becomes clear, and the distant scene gradually blurs.   |
|  | Aperture-.<br>It is used to reduce luminous flux.  |
|  | Aperture+.<br>It is use to increase luminous flux.   |
| Speed   | It specifies the speed of the camera PTZ. The larger the value, the faster the speed.  |
|   | No. It specifies the number of presets.  |
|   | Name It specifies the name of the preset.  |
| Preset  | It is used to perform operations for the preset:   |
|   | Operation  |
|   | <ul style="list-style-type: none"> <li>– Click  to use the currently adjusted monitoring direction and zoom as the parameters of the preset.</li> <li>– Click  to call the preset, control the PTZ camera to rotate to the monitoring position of the preset and apply the zoom of the preset.</li> <li>– Click  to delete the preset.</li> </ul> |
|   | No. It specifies the number of the patrol.   |
|   | Name It specifies the name of the patrol.  |
| Patrol  | It is used to perform operations for the patrol:   |
|   | Operation  |
|   | <ul style="list-style-type: none"> <li>– Click  to set preset for this patrol.</li> <li>– Click  to start patrol according to the added preset. Only one path can be patrolled at a time.</li> <li>– Click  to stop patrol.</li> </ul>  |

## Set Preset

Set the monitoring direction for a specific preset.

### Procedure:

**Step 1** [Log in to the GUI of the NVR.](#)

**Step 2** Click **Live View**, hover the mouse over the PTZ camera or dome channel you want to set preset, and click the PTZ control icon  at the bottom of the channel.

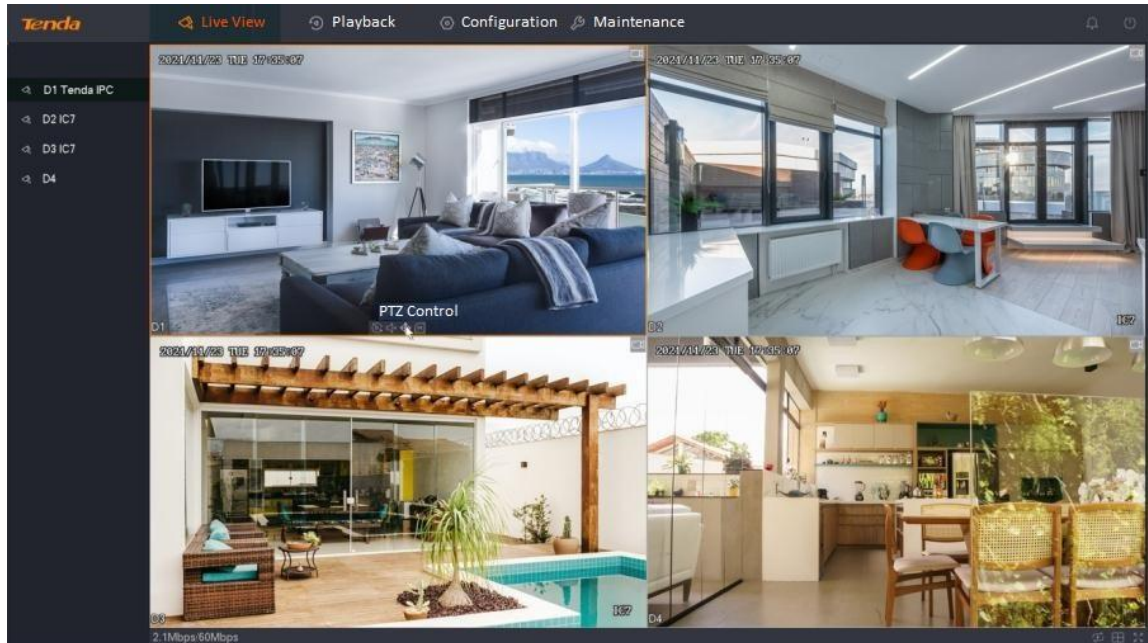

**Step 3** Use the arrow keys to control the camera to rotate to the desired monitoring position.

**Step 4** Click **Preset** tab, target the preset to which this monitoring direction is to be applied, and click .

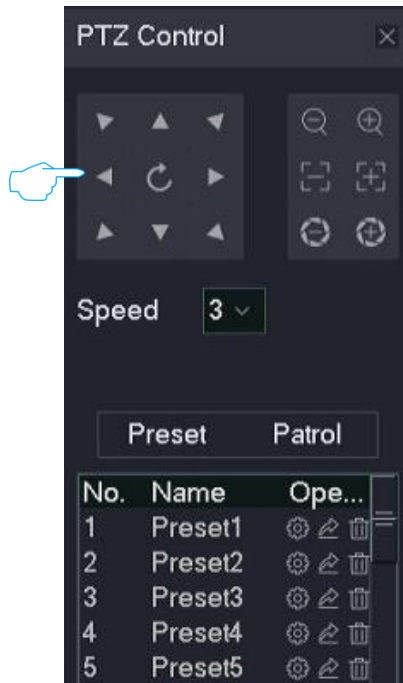

---End

## Set Patrol

Add the preset for a specific patrol.

### Procedure:

**Step 1** [Log in to the GUI of the NVR.](#)

**Step 2** Refer to [Set Preset](#) to add multiple preset.

**Step 3** Set patrol.

1. Click the **Patrol** tab.
2. Target the patrol you want to set and click , which is **Patrol 1** in this example.



3. Click **Add**.

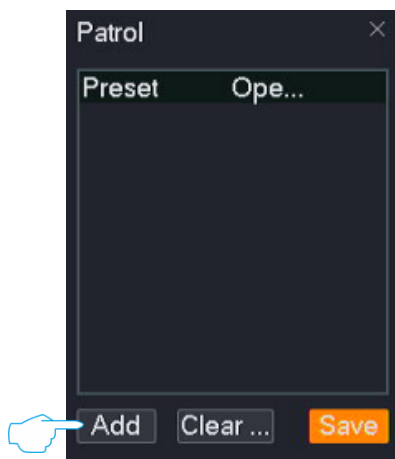

4. Select the preset you added, set PTZ speed and the dwell time to reach the preset, and click **OK**.

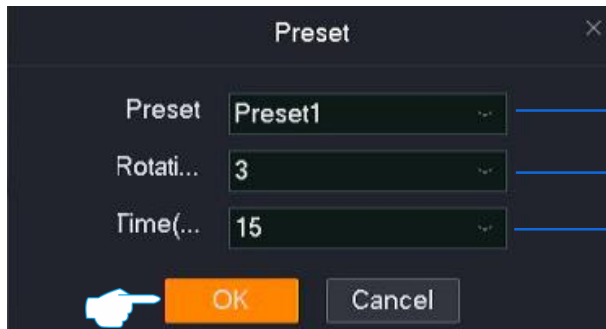

It specifies the preset used by the patrol need. It needs to be added in advance.

It specifies the speed at the preset.

It specifies the dwell time at the preset.

5. Repeat substep 4 to add the other preset and click **Save**.



- It specifies the preset of the patrol.
- Click to re-edit the used preset.
  - Click to move the preset up. Unavailable in the first preset.
  - Click to move the preset down. Unavailable in the last preset.
  - Click to delete the corresponding preset.

TIP

After the patrol parameters are adjusted, click **Save** to take effect.

---End



## Call Preset

Control the camera to rotate to the monitoring position of the specific preset.



Before the preset is called, you need to [Set the Preset](#) first.

### Procedure:

**Step 1** [Log in to the GUI of the NVR.](#)

**Step 2** Click **Live View**, hover the mouse over the camera channel you want to perform PTZ control, and click  at the bottom of the channel.

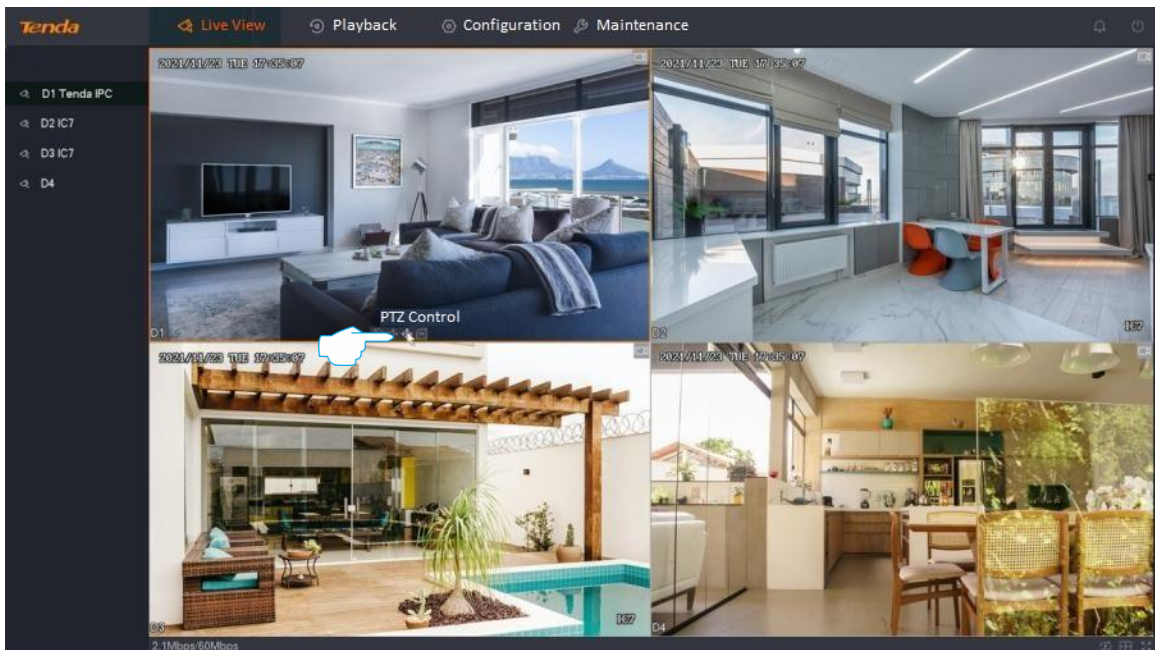

**Step 3** Click **Preset** tab, target the preset you want to call, and then click  .



---End

The camera will rotate to the monitoring position of this preset.

## Call Patrol

Control the camera patrols according to the specified track.





- Before the patrol is called, you can [Set the Preset](#) for this patrol first.
- Only one patrol can be called at the same time.

**Procedure:**

**Step 1** [Log in to the GUI of the NVR.](#)

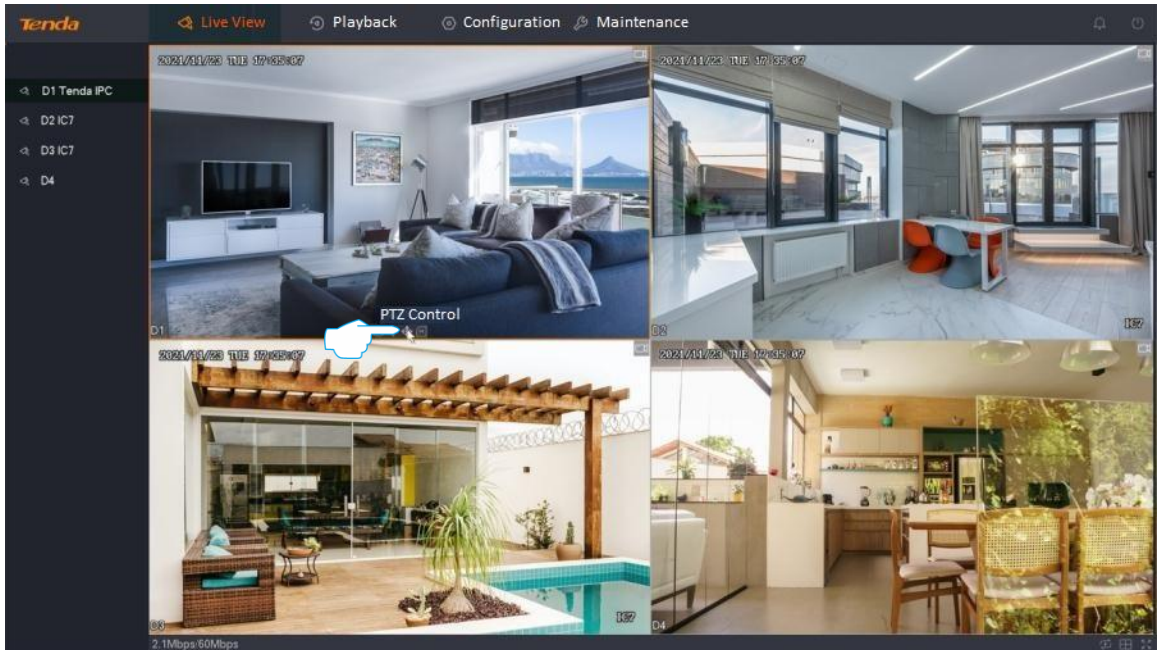
**Step 2** Click **Live View**, hover the mouse over the camera channel you want to perform PTZ control, and click  at the bottom of the channel.



**Step 3** Click the **Patrol** tab, target the patrol you want to call, and then click .



**---End**

The camera will automatically patrol in sequence according to the preset that has been added to the patrol. Click  to stop patrol.

## Set Camera Horizontal 360° Patrol

Control the camera to perform a horizontal 360° rotating patrol at the current position.

**Procedure:**

**Step 1** [Log in to the GUI of the NVR.](#)

**Step 2** Click **Live View**, hover the mouse over the camera channel you want to perform PTZ control, and click  at the bottom of the channel.

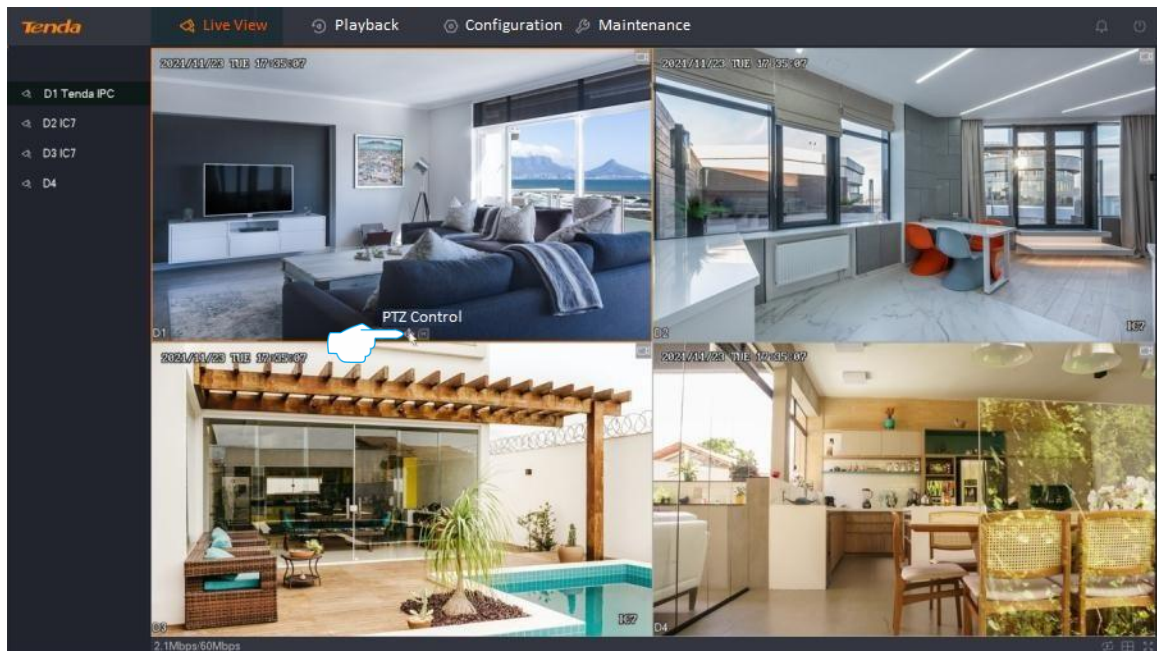

**Step 3** Click .

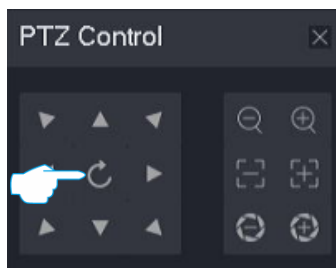

---End

The camera will perform a horizontal 360° rotating patrol at the current position until you click  again to stop the patrol.

## 4.4.8 Check Stream Info

You can check such real-time stream information as resolution, frame rate and bitrate of the channel as required on the live view page.

**Procedure:**

**Step 1** [Log in to the GUI of the NVR.](#)

**Step 2** Click **Live View**.

**Step 3** Hover the mouse over the channel you want to check the stream information, and click  at the bottom of the channel.



---End

## 4.4.9 Modify Channel Sequence

You can adjust the display sequence of each channel on the live view page as required.

### Procedure:

**Step 1** [Log in to the GUI of the NVR.](#)

**Step 2** Click **Live View** to ensure that the current live view mode is window division mode. If not, please set the live view mode to window division mode first. Refer to [Switch Window Division Mode](#) for detailed steps.

**Step 3** Click and drag the channel you want to adjust the live view position to another live view screen position, then release the mouse.

**---End**

The display positions of the two channels have been exchanged successfully.

## 4.5 Playback

On the playback page, you can play back or export recording files according to the search conditions. The NVR supports channel playback, file playback and tag playback.

### 4.5.1 Channel Playback

#### Overview





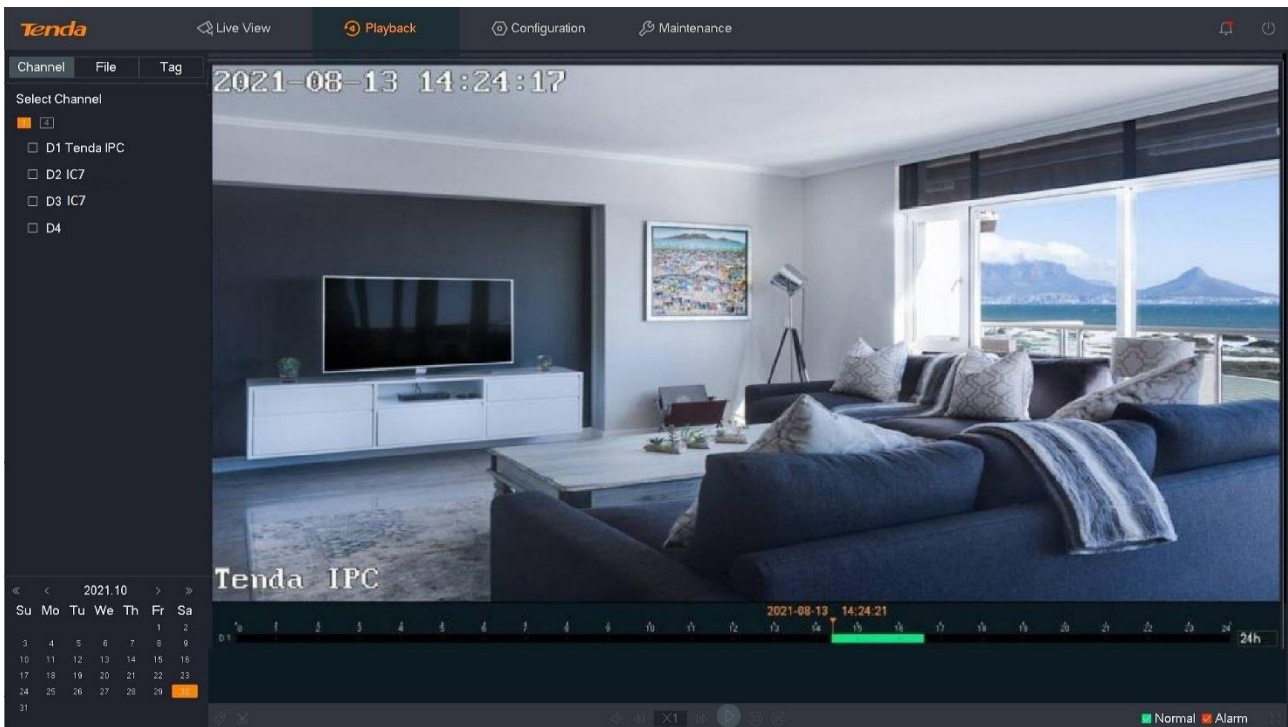



Navigate to **Playback > Channel**.

Channel playback indicates that you can search and play back the corresponding recording files according to the channel and date. You can check, tag, clip and export the recording files as required.

















#### Parameter description

| Parameter      | Description   |
|----------------|---|
| Select Channel | Channel number selection shortcut button.<br>It is used to quickly select single or multiple channels. The selected channel will be displayed on the live view page on the right. |

| Parameter                    |   | Description  |
|------------------------------|---|--|
|                              | 1-4, 5-8, 1-8   | Channel quick selection.<br>It is used to quickly select a target channel after a channel is selected through the <b>channel selection shortcut button</b> . The selected channel will be displayed on the live view page on the right.  |
|                              | D1 - D4   | Channel number.<br>If you want to play back the recording of a target channel, tick the channel number. The selected channel will be displayed on the live view page on the right.   |
| Select Date                  |    | Previous year.<br>Click it to enter the previous year of the currently displayed year.   |
|                              |    | Previous month.<br>Click it to enter the previous month of the currently displayed month.  |
|                              |    | Next month.<br>Click it to enter the next month of the currently displayed month.  |
|                              |  | Next year.<br>Click it to enter the next year of the currently displayed year.   |
|                              |  | An orange triangle icon on the upper-right of the date indicates that there is a recording.  |
|                              |  | The date in orange shading indicates the currently selected date.  |
|                              |  | The date with an orange frame indicates the date of the current system time.   |
| Time Bar                     | /   | <p>It specifies the recording type and time under the current filter conditions.</p> <ul style="list-style-type: none"> <li>Click any position in the color area on the time bar to play back from here.</li> <li>The time bar color varies with recording file types. Green means normal recording and red means alarm recording.</li> </ul> <p> <b>TIP</b></p> <p>Up to 4 channels can be displayed. If you select more than 4 channels, only the currently selected channel will be displayed.</p> |
| Time Granularity of Time Bar |  | <p>It specifies the time unit on the time bar.</p> <p>The default time is 24 hours. The smaller the time unit, the larger the time scale. The time unit can be adjusted by the mouse wheel.</p>  |



| Parameter   | Description   |  |
|---|---|--|
|    | Previous period.<br>It is used to switch the period to the previous period according to the current time unit.  |  |
|    | Next period.<br>It is used to switch the period to the next period according to the current time unit.  |  |
|    | It is used to tag a recording.<br>Click it to set a tag for the recording at a certain moment. It is convenient for users to search for recording files according to the tag field. |  |
|    | Click it to clip recording files.   |  |
|    | Click it to export clipped recording files to a USB storage device.   |  |
|   | Click it to mute or unmute the recording file audio. By default, the recording is mute.   |  |
|  | Slow down.<br>Click it to decrease the video playback speed and switch it to slow-down mode.  |  |
| Playback Control Area   |    | It specifies the multiplier of the playback speed.   |
|   |    | Speed up.<br>Click it to increase the video playback speed and switch it to speed-up mode. |
|   |    | Click it to play or pause recording files.   |
|   |    | Click it to go back 30 seconds.  |
|   |    | Click it to forward 30 seconds.  |
|   |    | It specifies the ordinary recording files.   |
|   |    | It specifies the alarm recording file.   |
|   |    | Click it to display in full-screen.  |

## Play Back the Recordings of the Target Channel

Assume that you want to play back the recordings of D1 to D4 on October 30, 2021.

**Procedure:**

**Step 1** [Log in to the GUI of the NVR.](#)

**Step 2** Navigate to **Playback > Channel**.

**Step 3** Click .

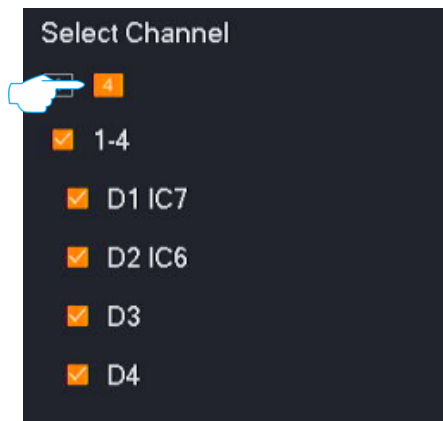

**Step 4** Select the date, which is **October 30, 2021**, in this example.



**Step 5** Edit the time bar and playback control area to play back the recordings as required.

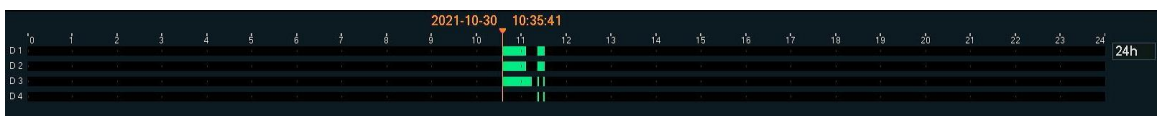

---End

## 4.5.2 File Playback

### Overview

Navigate to **Playback > File**.

File playback indicates that you can check the recording files of the channel in a specific period according to the file type (including normal, alarm and all). You can check, export, tag, clip and export the recording files as required.

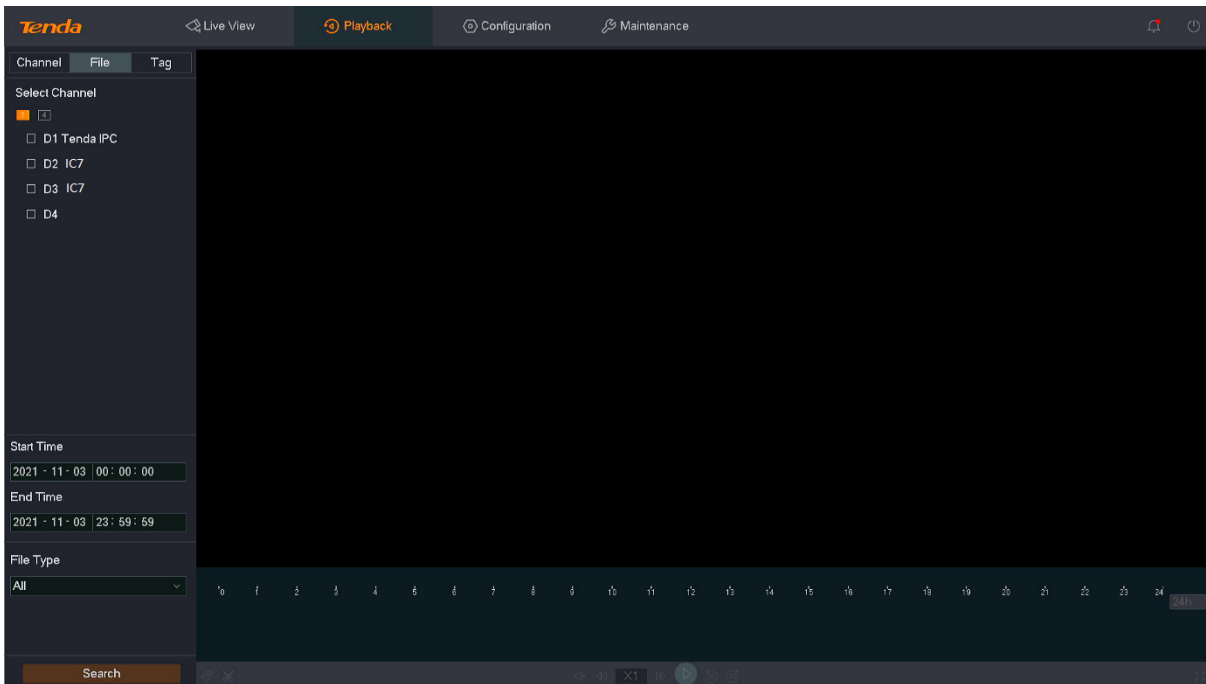

### Parameter description

| Parameter  | Description   |
|--|---|
| <input type="checkbox"/> 1, <input type="checkbox"/> 4, <input type="checkbox"/> 8 | Channel selection shortcut button.<br>It is used to quickly select single or multiple channels. The selected channel will be displayed on the live view page on the right.  |
| Select Channel   | Channel quick selection.<br>It is used to quickly select a target channel after a channel is selected through the <b>channel selection shortcut button</b> . The selected channel will be displayed on the live view page on the right. |
| D1 - D4  | Channel number.<br>Tick the channel number to play back the recording of a target channel. The selected channel will be displayed on the live view page on the right.   |

| Parameter  | Description |  |
|------------|-------------|--|
| Start Time | /           |  |
| End Time   | /           |  |
| File Type  | Normal      | It specifies the recording file is a normal recording.                         |
|            | Alarm       | It specifies the recording file is an alarm recording.                         |
|            | All         | It specifies the recording file contains normal recording and alarm recording. |



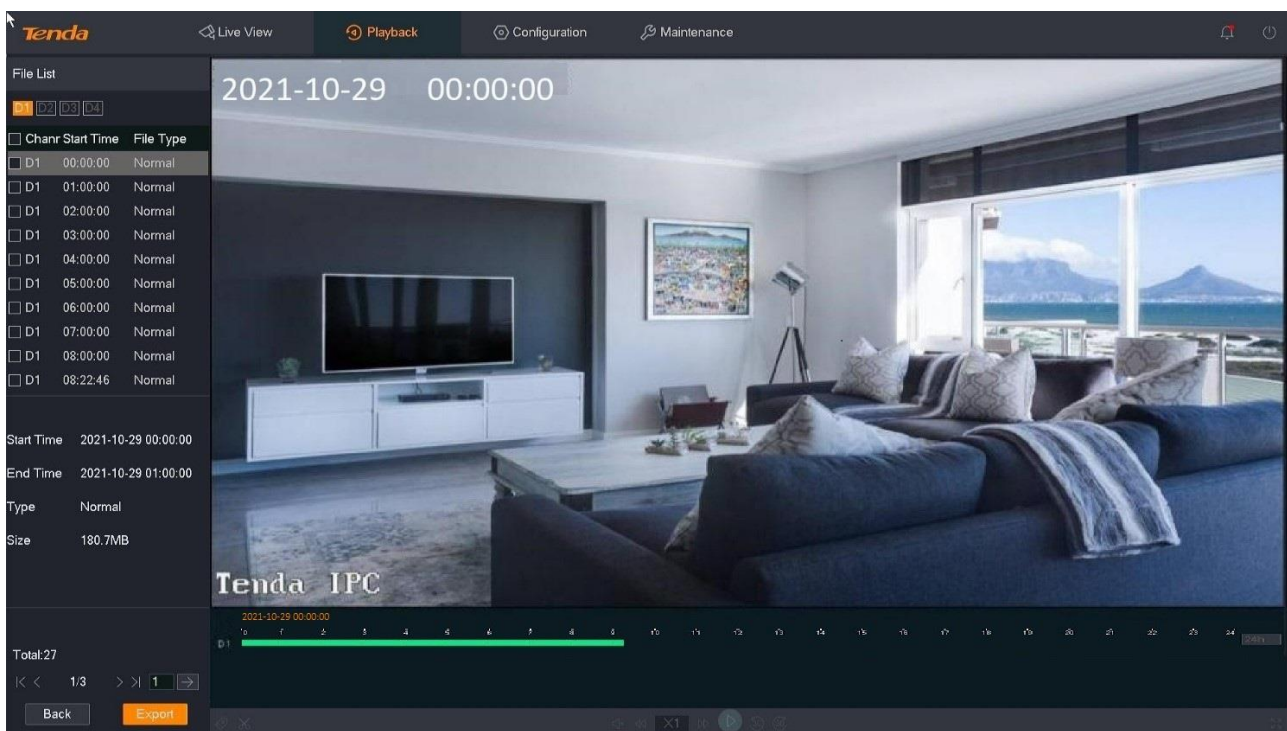





After the channel, time, and file type are configured, you can search for the recording files, double-click the recording file to play back, and edit it according to the actual situation.



### Some parameter description

Refer to [parameter description of channel playback](#) for other parameter description.

| Parameter | Description   |
|-----------|---|
| File List | It specifies the recording file searched according to conditions.             |
| D1 - D4   | It specifies the channel number.  |
|           | Click a specific channel number to filter the recording files of the channel. |

| Parameter   | Description   |
|---|---|
| Channel   | It specifies the channel to which the recording file belongs.   |
| Start Time  | It specifies the start time of the recording file.  |
| File Type   | It specifies the type of the recording file, including normal and alarm.  |
| Start Time  | It specifies the start date and time of the currently selected recording file. The first recording file is selected by default. |
| End Time  | It specifies the end date and time of the currently selected recording file. The first recording file is selected by default.   |
| Type  | It specifies the type of the currently selected recording file. The first recording file is selected by default.                |
| Size  | It specifies the size of the currently selected recording file. The first recording file is selected by default.                |
|   | Home page.<br>Click it to redirect to the home page of the file list.   |
|  | Previous page.<br>Click it to redirect to the previous page of the current file list.   |
|  | Next page.<br>Click it to redirect to the next page of the current file list.   |
|  | Last page.<br>Click it to redirect to the last page of the file list.   |
|  | Specific page.<br>Click it to redirect to the specific page of the file list.   |
|  | Click it to go back to the <b>File Playback</b> page.   |
|  | Click it to export the selected recording file.   |
|  | <b>TIP</b><br>Only one page of recording files can be exported at a time.   |

## Play Back Normal or Alarm Recording

Assume that you want to check and play back all recordings of D1 from 00:00:00 to 23:59:59 on October 29, 2021.

### Procedure:

**Step 1** [Log in to the GUI of the NVR.](#)

**Step 2** Navigate to **Playback > File.**

**Step 3** Tick D1.

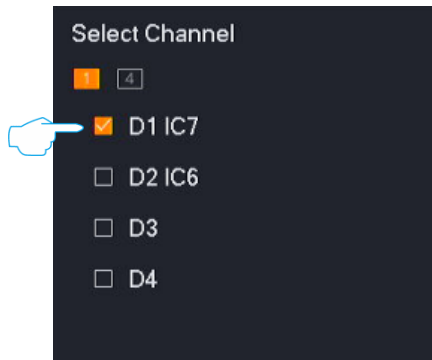

**Step 4** Select the time, which is **00:00:00** to **23:59:59** on **October 29, 2021**, in this example.

**Step 5** Select the file type, which is **All** in this example.

**Step 6** Click **Search**.

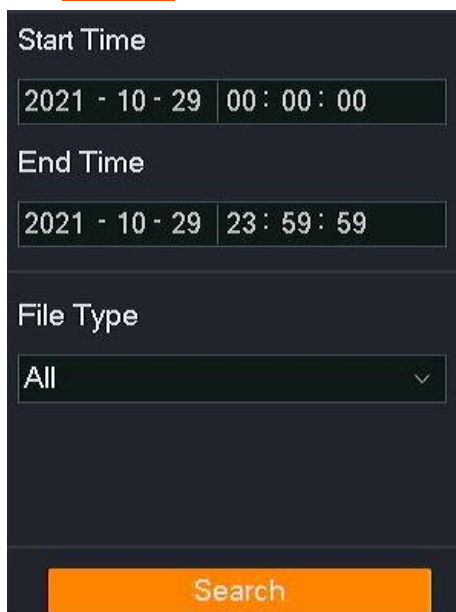

**Step 7** Searched successfully. You can double-click the recording file to view the recording file in the live view window on the right and edit it as required.



---End

## Export Recording File

Assume that you want to export all recordings of D3 from 00:00:00 to 23:59:59 on October 29, 2021.



The NVR can recognize USB storage devices formatted as FAT32, exFAT and NTFS.

### Method 1

It is applicable for the NVR that cannot be connected to the mouse and the USB storage device at the same time.

**Step 1** [Log in to the GUI of the NVR.](#)

**Step 2** Navigate to **Playback > File**, and tick **D3**.

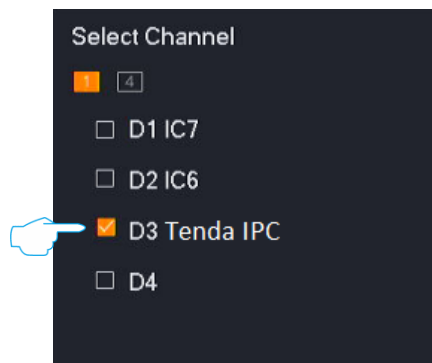

**Step 3** Select the time, which is **00:00:00** to **23:59:59** on **October 29, 2021**.

**Step 4** Select the file type, which is **Alarm** in this example, then click **Search**.

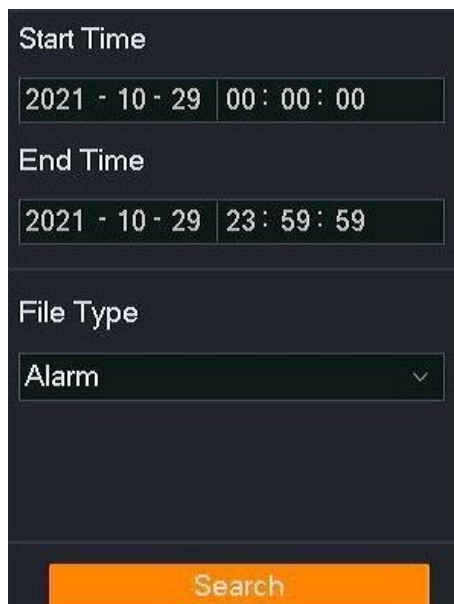



**Step 5** Select all alarm recording files on the current page, then click **Export**.



Only one page of recording files can be exported at a time.

File List

D1  D2  D3  D4

| <input checked="" type="checkbox"/> | Chanr | Start Time | File Type |
|-------------------------------------|-------|------------|-----------|
| <input checked="" type="checkbox"/> | D3    | 15:36:28   | Alarm     |
| <input checked="" type="checkbox"/> | D3    | 15:36:53   | Alarm     |
| <input checked="" type="checkbox"/> | D3    | 15:37:26   | Alarm     |
| <input checked="" type="checkbox"/> | D3    | 15:39:33   | Alarm     |
| <input checked="" type="checkbox"/> | D3    | 15:51:16   | Alarm     |

Start Time 2021-10-30 15:36:28

End Time 2021-10-30 15:36:42

Type Alarm

Size 0.9MB

Total:5

<< < 1/1 > >> 1 →

**Step 6** Unplug the mouse and connect the USB storage device to the USB port of the NVR within 1 minute.



---End

The recording files with the suffix of .mp4 (R means normal recording, M means alarm recording) will be exported to the root directory of the USB storage device.

## Method 2

It is applicable for the NVR that can be connected to the mouse and the USB storage device at the same time.



If the NVR has only one USB port or the USB port has been used, you need to prepare a USB hub by yourself.

---

**Step 1** Connect the USB storage device to the USB port of the NVR.

**Step 2** [Log in to the GUI of the NVR.](#)

**Step 3** Navigate to **Playback > File**, and tick D3.

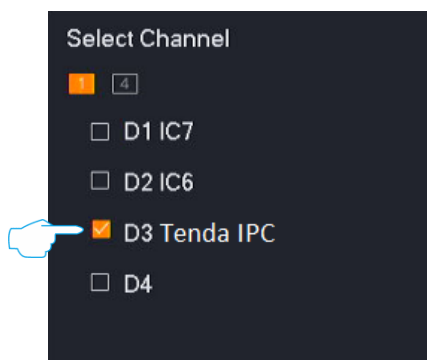

**Step 4** Select the time, which is **00:00:00** to **23:59:59** on **October 29, 2021**, in this example.

**Step 5** Select the file type, which is **Alarm** in this example, then click **Search**.

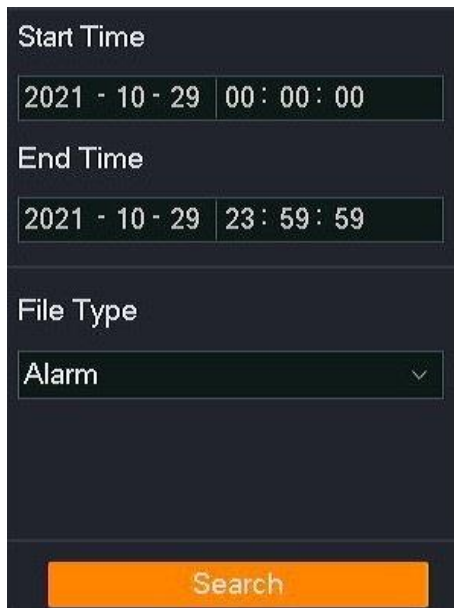

The image shows a dark-themed search filter interface. It contains three input fields and a search button. The first field is labeled "Start Time" and contains the text "2021 - 10 - 29" followed by "00 : 00 : 00". The second field is labeled "End Time" and contains "2021 - 10 - 29" followed by "23 : 59 : 59". The third field is labeled "File Type" and contains a dropdown menu with "Alarm" selected. At the bottom of the form is an orange button labeled "Search".

**Step 6** Select all alarm recording files on the current page, then click **Export**.



Only one page of recording files can be exported at a time.

File List

D1 D2 **D3** D4

| <input checked="" type="checkbox"/> | Chanr | Start Time | File Type |
|-------------------------------------|-------|------------|-----------|
| <input checked="" type="checkbox"/> | D3    | 15:36:28   | Alarm     |
| <input checked="" type="checkbox"/> | D3    | 15:36:53   | Alarm     |
| <input checked="" type="checkbox"/> | D3    | 15:37:26   | Alarm     |
| <input checked="" type="checkbox"/> | D3    | 15:39:33   | Alarm     |
| <input checked="" type="checkbox"/> | D3    | 15:51:16   | Alarm     |

Start Time 2021-10-30 15:36:28

End Time 2021-10-30 15:36:42

Type Alarm

Size 0.9MB

Total:5

<< 1/1 >> 1 →

Back Export

**Step 7** Select your USB storage device from the **USB Device** drop-down list box, then click **Export**.

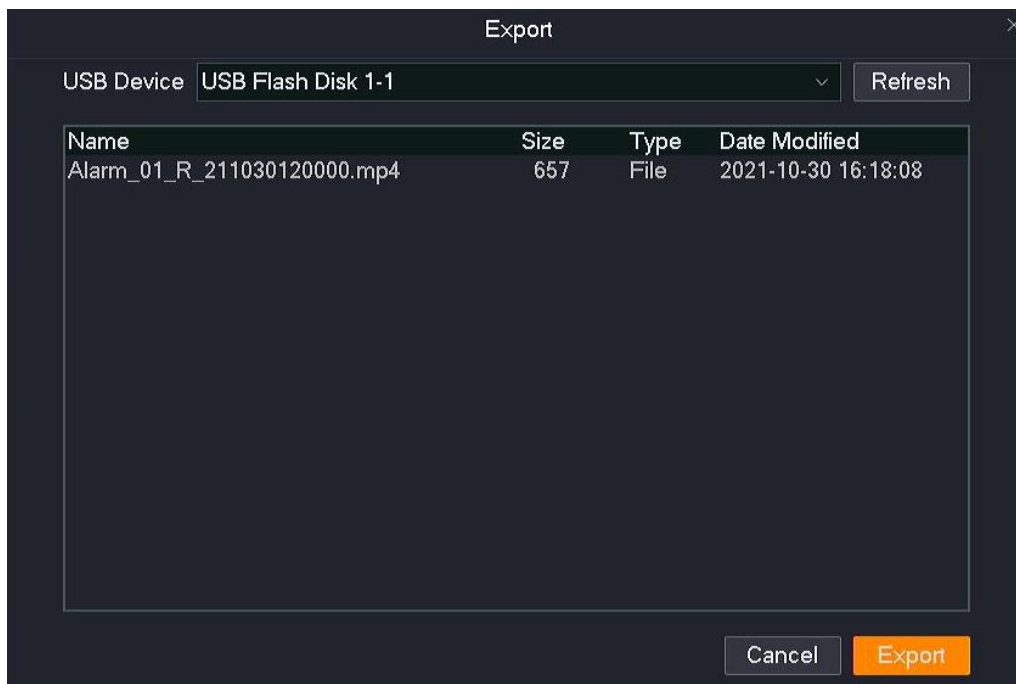

**Step 8** After the files are exported successfully, if you want to continue to export the recording files on other pages, please redirect to the recording files on that page and repeat **Step 6** to **Step 7**.

---End

The recording files with the suffix of .mp4 (R means normal recording, M means alarm recording) will be exported to the root directory of the USB storage device.

### 4.5.3 Add Tag

#### Overview

Tag playback function refers to you can add a tag to the recording at a moment when the recording is played back, so that the recording file can be quickly located by the tag name. The system supports searching and positioning by tag keywords.

#### Add Tag for Channel Recording File

Assume that you found an alarm recording when you searched the recording file of D1 all day on October 30, 2021, and you want to add a tag to this recording.

**Procedure:**

**Step 1** [Log in to the GUI of the NVR.](#)

**Step 2** Navigate to **Playback > Channel.**

**Step 3** Tick **D1.**

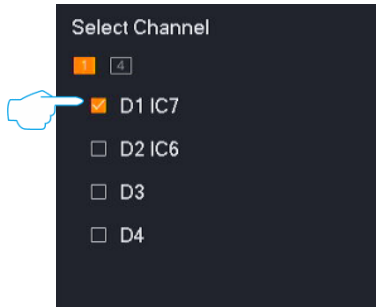

**Step 4** Select the date, which is **October 30, 2021**, in this example.

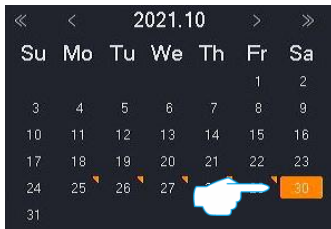

**Step 5** Left-click the time point you want to tag on the right time bar, then click  (tag) in the lower-left corner. The recording type is alarm recording in this example.

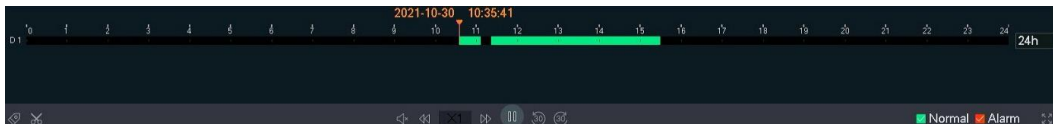

**Step 6** Set the name of the tag, then click **Save**.

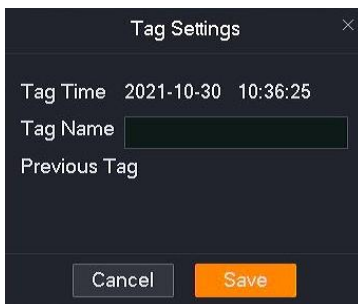

**---End**

After the setting completes, you can search the recording file according to the tag name on the **Tag** page.

## Add Tag for the Searched Recording File

Assume that you want to add a tag to a target alarm recording when you are viewing the alarm recording files of D1 all day on October 30, 2021.

### Procedure:

**Step 1** [Log in to the GUI of the NVR.](#)

**Step 2** Navigate to **Playback > File**.

**Step 3** Tick D1.

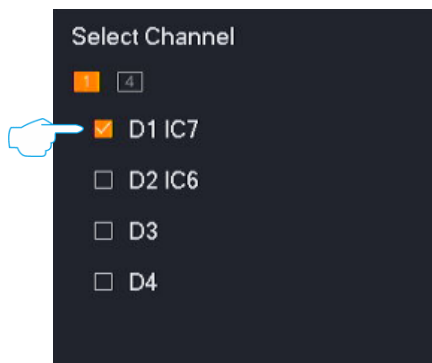

**Step 4** Select the time, which is **00:00:00** to **23:59:59** on **October 30, 2021**, in this example.

**Step 5** Select the file type, which is **Alarm** in this example, then click **Search**.

**Step 6** Double-click the recording file on the left to play back the recording file on the right, then click  (tag) in the lower-left corner.



**Step 7** Set the name of the tag, then click **Save**.

Tag Settings

Tag Time 2021-10-30 10:36:25

Tag Name

Previous Tag

Cancel Save

After the setting completes, you can search the recording file according to the tag name on the **Tag** page.

**---End**



## 4.5.4 Tag Playback

### Overview

Navigate to **Playback > Tag**.

Tag playback refers to you can check the tagged recordings according to the channel, tag time and tag name. You can view, tag, clip and export the recording files as required.

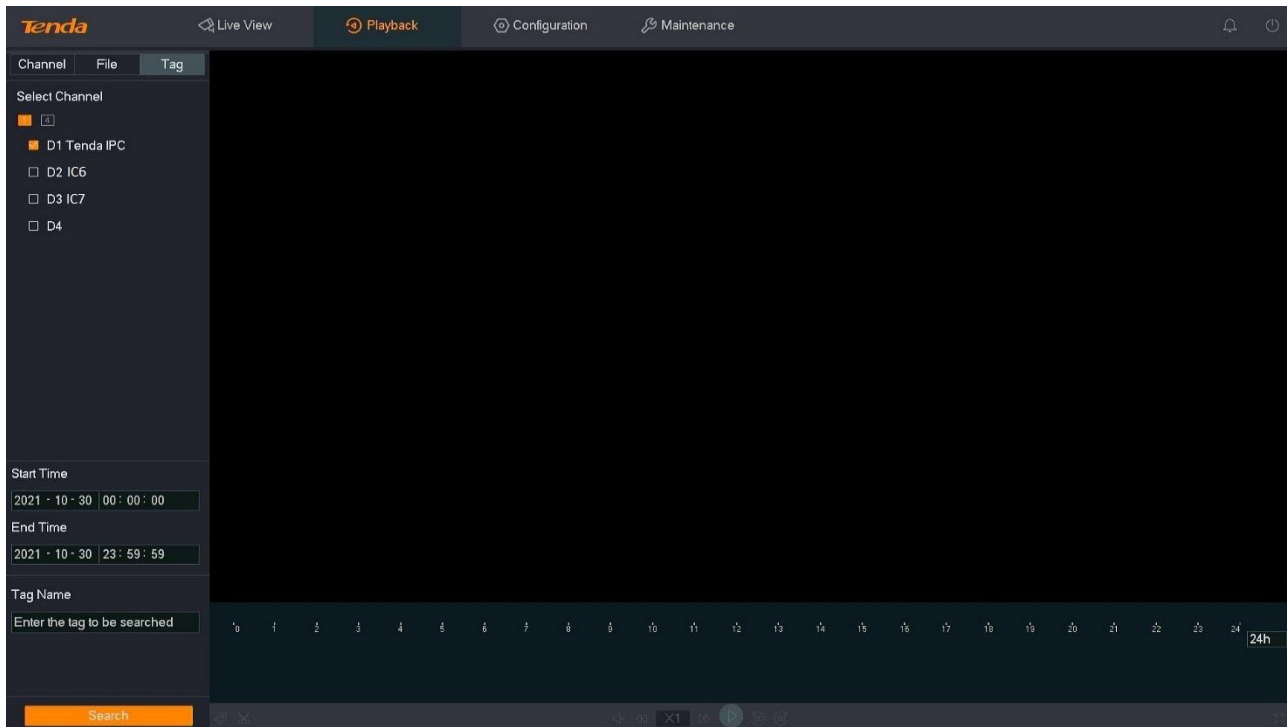

### Parameter description

| Parameter  | Description   |
|--|---|
| <input type="checkbox"/> 1, <input type="checkbox"/> 4, <input type="checkbox"/> 8 | Channel number selection shortcut button.<br>It is used to quickly select single or multiple channels. The selected channel will be displayed on the live view page on the right.   |
| Select Channel   | Channel quick selection.<br>It is used to quickly select a target channel after a channel is selected through the <b>channel selection shortcut button</b> . The selected channel will be displayed on the live view page on the right. |
| D1 - D4  | Channel number.<br>If you want to play back the recording of a target channel, tick the channel number. The selected channel will be displayed on the live view page on the right.  |

| Parameter    | Description   |
|--------------|---|
| Start Time / | They specify the start time and end time of the recording file. |
| End Time /   |   |
| Tag Name /   | It specifies the tag name of the recording file.                |











After the channel, time, and tag name are configured, you can search for the recording files. Double-click the recording file to play back, and you can edit it according to the actual situation.



### Some parameter description

Refer to [parameter description of channel playback](#) for other parameter description.

| Parameter        | Description  |
|------------------|--|
| Tagged Recording | It specifies the recording file searched according to conditions.  |
| D1 - D4          | Channel number.<br>It specifies you can click a target channel number to filter the recording file of the channel. |
| Channel          | It specifies the channel to which the recording file belongs.  |
| Time             | It specifies the time of tagging.  |

| Parameter   | Description  |
|---|--|
| Name  | It specifies the tag name of the recording file.   |
| Operation   | <p>It is used to perform operations for the recorded file:</p> <ul style="list-style-type: none"> <li>– Click  to edit the tag name of the recording file.</li> <li>– Click  to delete the tag of the recording file.</li> </ul> |
|    | <p>Home page.</p> <p>Click it to redirect to the home page of the file list.</p>   |
|    | <p>Previous page.</p> <p>Click it to redirect to the previous page of the current file list.</p>   |
|    | <p>Next page.</p> <p>Click it to redirect to the next page of the current file list.</p>   |
|    | <p>Last page.</p> <p>Click it to redirect to the last page of the file list.</p>   |
|  | <p>Specific page.</p> <p>Click it to redirect to the specific page of the file list.</p>   |
|  | Click it to go back to the file page.  |
|  | <p>Click it to export the selected recording file.</p> <p> <b>TIP</b></p> <p>Only one page of recording files can be exported at a time.</p>  |

## Play Back Specific Tagged Recording

Assume that you want to check and play back the recording files whose tag name is **Human** in D1 to D4 on October 30, 2021.

### Procedure:

**Step 1** [Log in to the GUI of the NVR.](#)

**Step 2** Navigate to **Playback > Tag**.

**Step 3** Click .

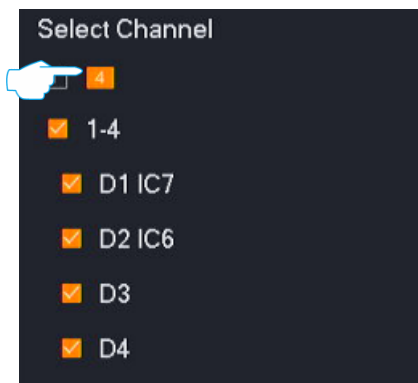

**Step 4** Select the time, which is **00:00:00** to **23:59:59** on **October 30, 2021**, in this example.

**Step 5** Enter the tag name of the recording file you want to search in **Tag Name**, which is **Human** in this example.

**Step 6** Click **Search**.

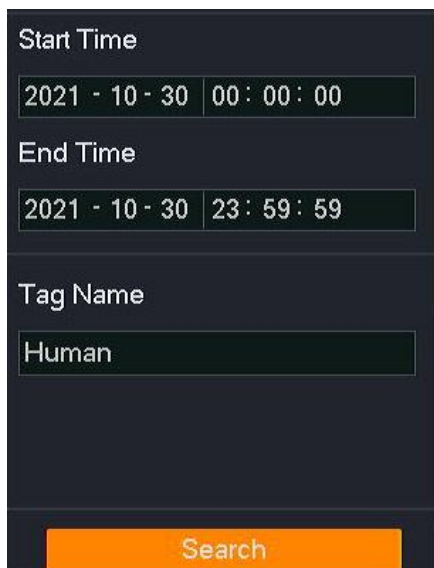

**Step 7** After the search completes, you can double-click the recording file to view the recording file in the live view window on the right and edit it as required.

**---End**

## Manage Tagged Recording

### Modify Tag Name

Assume that you want to modify the tag name **Human** of the recording files in D1 to D4 on October 30, 2021, to **Human Detection**.

#### Procedure:

**Step 1** [Log in to the GUI of the NVR.](#)

**Step 2** Navigate to **Playback > Tag** and click .

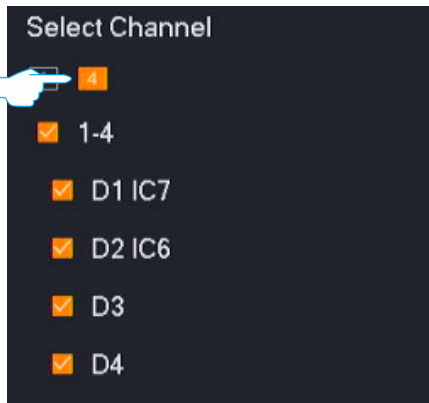

**Step 3** Select the time, which is **00:00:00** to **23:59:59** on **October 30, 2021**, in this example.

**Step 4** Enter the tag name of the recording file you want to search in **Tag Name**, which is **Human** in this example.

**Step 5** Click **Search**.

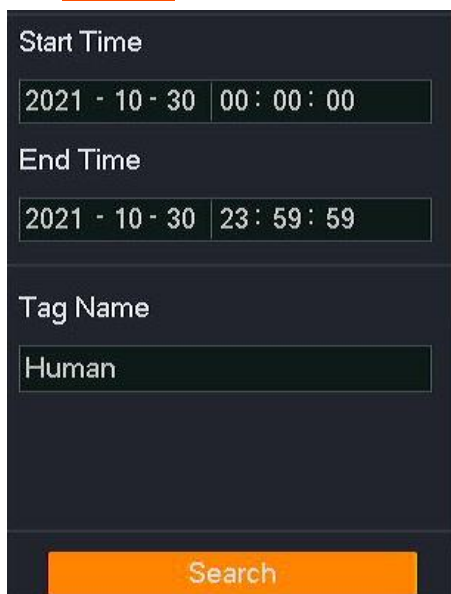

**Step 6** Select the channel number to filter the recording files that meet the conditions, and click  behind the recording file. Modify the tag name in the pop-up dialog window, which is

**Human detection** in this example, and click **Save**.

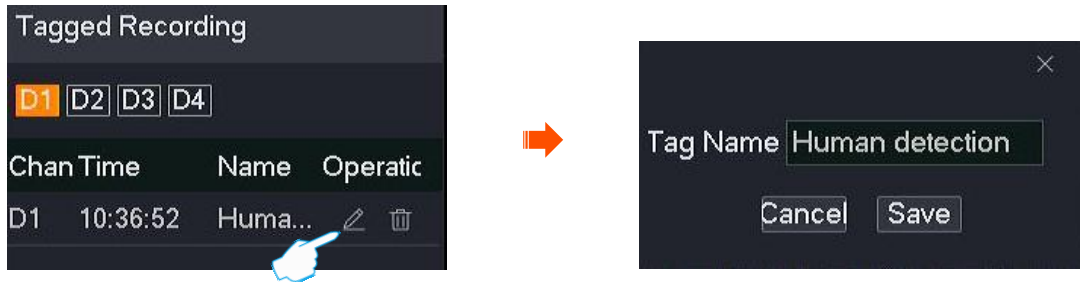

**Step 7** Repeat **Step 6** to modify the tag names of other channel recording files.

---End

## Delete Tag

Assume that you want to delete the tag name **Human detection** in D1 on October 30, 2021.

### Procedure:

**Step 1** [Log in to the GUI of the NVR.](#)

**Step 2** Navigate to **Playback > Tag**, and tick D1.

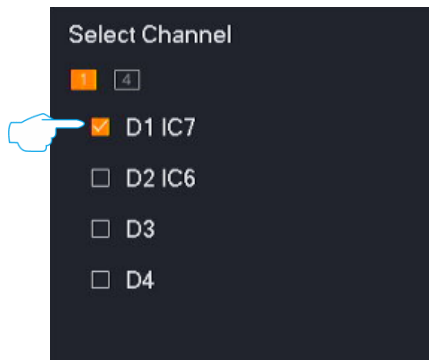

**Step 3** Select the time, which is **00:00:00** to **23:59:59** on **October 30, 2021**, in this example.

**Step 4** Enter the tag name of the recording file you want to delete in **Tag Name**, which is **Human detection** in this example.

**Step 5** Click **Search**.

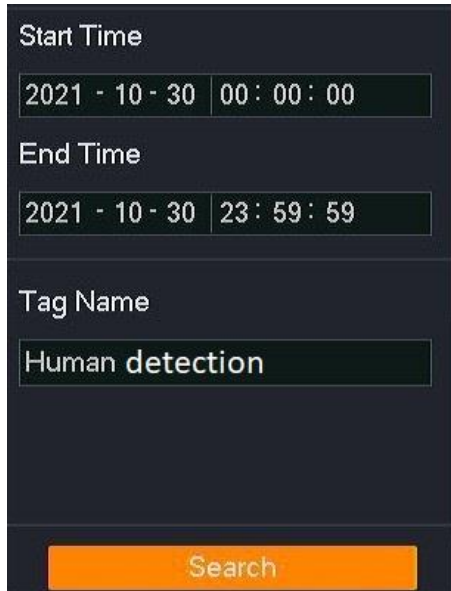

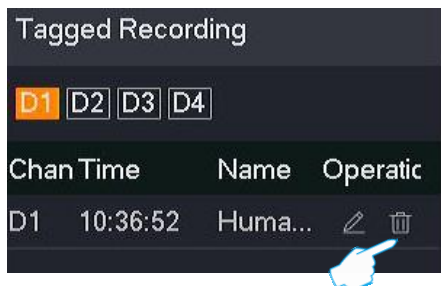

A dark-themed search dialog box with three input fields and a search button. The 'Start Time' field contains '2021 - 10 - 30 00 : 00 : 00'. The 'End Time' field contains '2021 - 10 - 30 23 : 59 : 59'. The 'Tag Name' field contains 'Human detection'. An orange 'Search' button is at the bottom.

**Step 6** Find the tag of the recording file that you want to delete, and click  behind the recording file. Click **OK** in the pop-up dialog window.



A 'Tagged Recording' window showing a table of recordings. The first row is highlighted. A blue hand cursor points to the trash icon in the 'Operatic' column.

| Chan | Time     | Name    | Operatic  |
|------|----------|---------|---|
| D1   | 10:36:52 | Huma... |   |

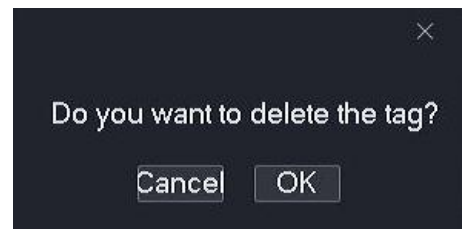

A dark-themed confirmation dialog box with a close button (X) in the top right corner. The text reads 'Do you want to delete the tag?'. At the bottom are 'Cancel' and 'OK' buttons.

**Step 7** Repeat **Step 6** to delete the tags of other channel recordings files.

**---End**

## 4.5.5 Clip and Export the Recording File

Assume that you want to intercept a target recording and save it to the USB storage device.



The NVR can recognize USB storage devices formatted as FAT32, exFAT and NTFS.

### Method 1

It is applicable for the NVR that cannot be connected to the mouse and the USB storage device at the same time.

**Step 1** [Log in to the GUI of the NVR.](#)

**Step 2** Enter the **Playback** page to play back the recording file.

**Step 3** Click  in the lower-left corner.

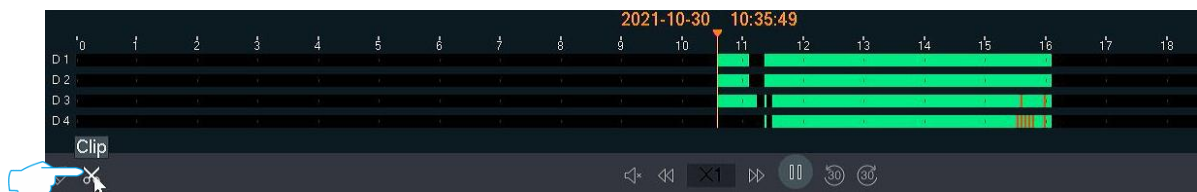

When multi-channel recordings are played back, the clipped recording file is the file of the currently selected channels.

**Step 4** Set the start time and end time of the editing, which are **00:11:00** to **00:16:00** in this example, and then click .

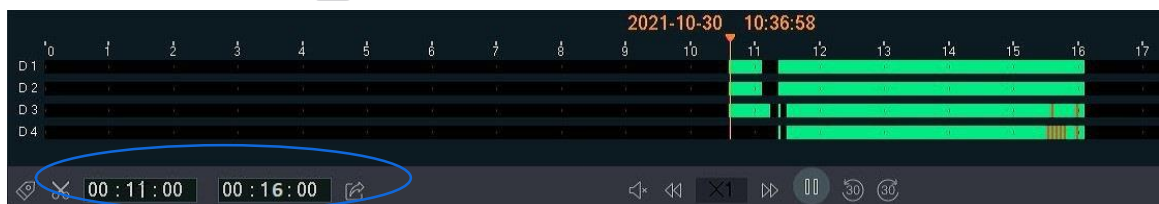

**Step 5** Set the name of the recording file, which is **Alarm** in this example, and click **Export**.

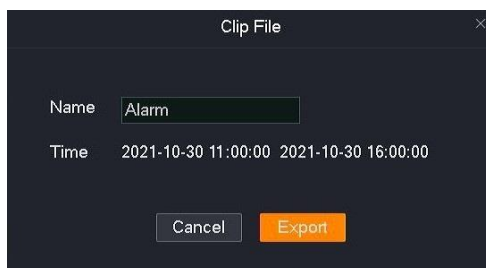



**Step 6** Unplug the mouse and connect the USB storage device to the USB port of the NVR within 1 minute.



---End

The recording files with the suffix of .mp4 (R means normal recording, M means alarm recording) will be exported to the root directory of the USB storage device.

## Method 2

It is applicable for the NVR that can be connected to the mouse and the USB storage device at the same time.



If the NVR has only one USB port or the USB port has been used, you need to prepare a USB hub by yourself.

**Step 1** Connect the USB storage device to the USB port of the NVR.

**Step 2** [Log in to the GUI of the NVR.](#)

**Step 3** Enter the GUI of the NVR. Enter the **Playback** page to play back the recording file.

**Step 4** Click  in the lower-left corner.

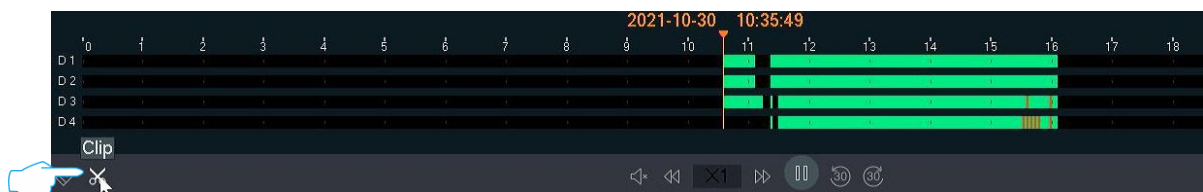

When multi-channel recordings are played back, the clipped recording file is the recording file of the currently selected channel.

**Step 5** Set the start time and end time of the editing, which are **00:11:00** to **00:16:00** in this example, and then click .

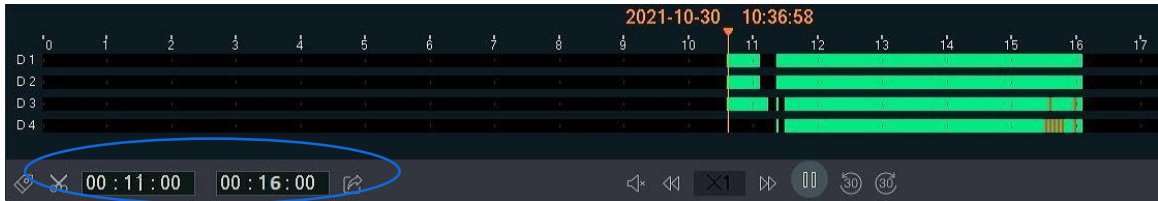

**Step 6** Set the name of the recording file, which is **Alarm** in this example, and click **Export**.

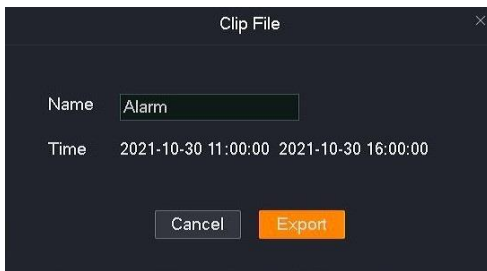

**Step 7** Click the drop-down list of the **USB Device** to select your USB storage device, and click **Export**.

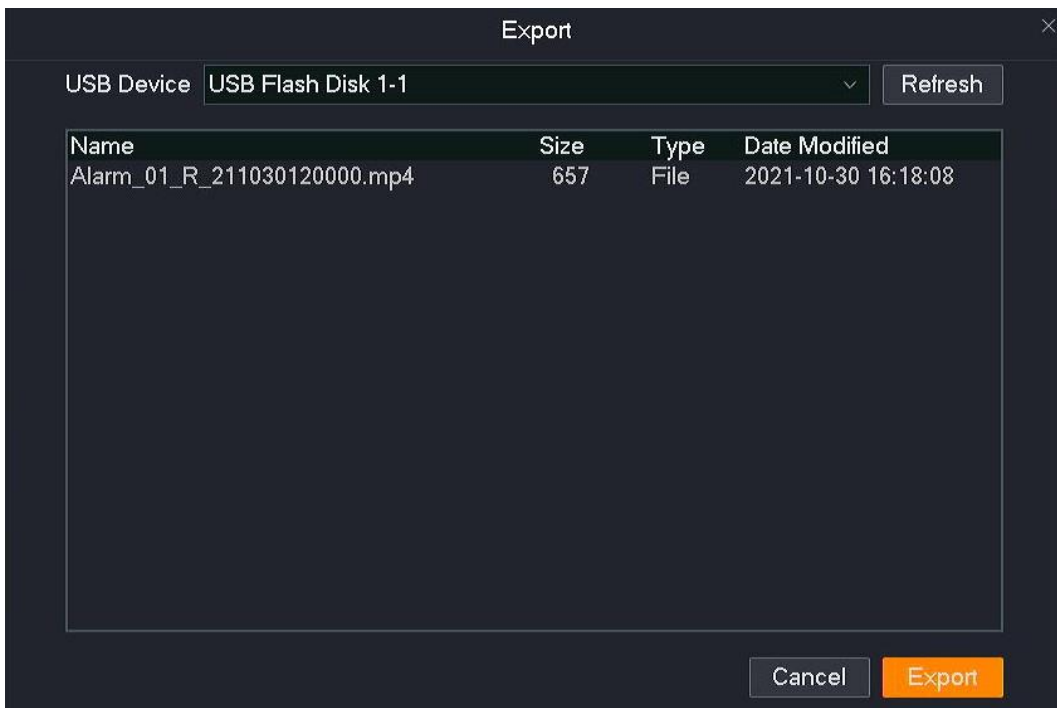

**---End**

The recording files with the suffix of .mp4 (R means normal recording, M means alarm recording) will be exported to the root directory of the USB storage device.

## 4.6 Configuration

On the configuration page, you can configure the primary functional parameters of the device, including channel management, storage management, alarm management, network configuration, and system configuration.

The configuration page supports basic settings and professional settings. Unless otherwise specified, the professional settings are illustrated here.

### 4.6.1 Show or Hide Professional Setting

Click **Configuration** to enter the page.

The professional mode is disabled by default. If you want to enable the professional mode for more settings, perform the following operations.

Enter the GUI of the NVR, click **Configuration**, find and click **Show Pro Settings** in the lower-left corner.

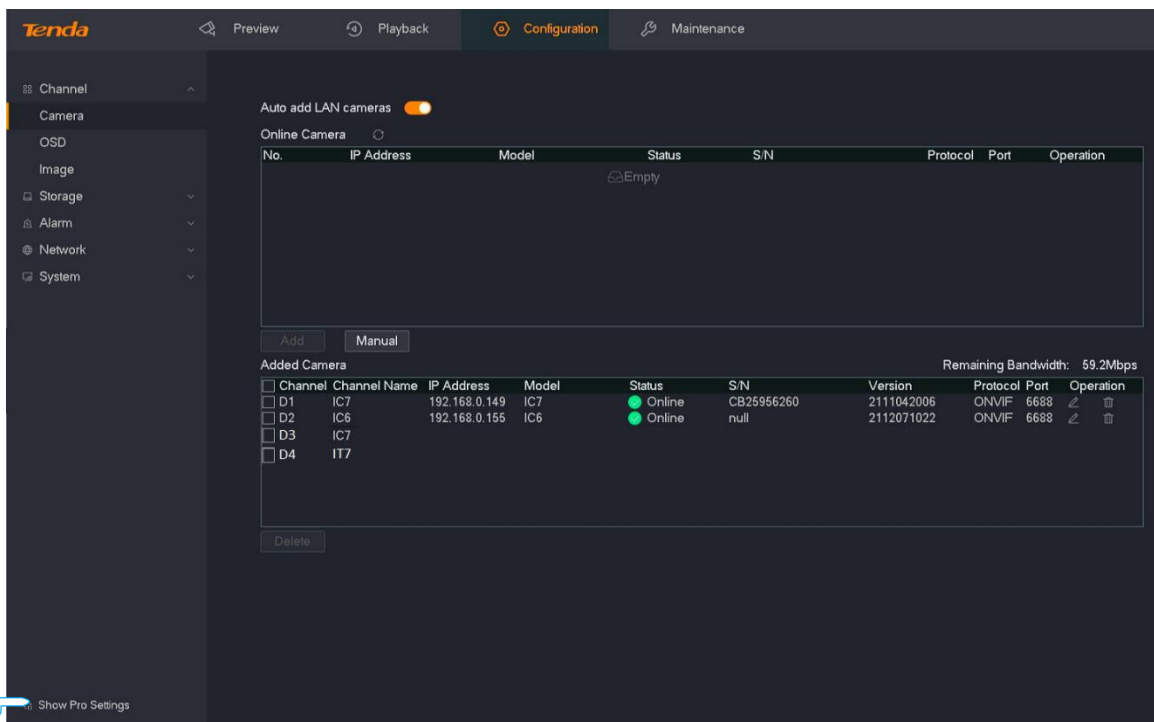

The screenshot displays the Tenda NVR Configuration page. The top navigation bar includes 'Preview', 'Playback', 'Configuration' (selected), and 'Maintenance'. The left sidebar lists 'Channel', 'Camera', 'OSD', 'Image', 'Storage', 'Alarm', 'Network', and 'System'. The main content area shows 'Auto add LAN cameras' as a toggle switch (turned on). Below it is an 'Online Camera' table with columns: No., IP Address, Model, Status, S/N, Protocol, Port, and Operation. The table is currently empty, showing 'Empty'. Below the table are 'Add' and 'Manual' buttons. Underneath is an 'Added Camera' table with columns: Channel, Channel Name, IP Address, Model, Status, S/N, Version, Protocol, Port, and Operation. The 'Remaining Bandwidth' is shown as 59.2Mbps. The 'Added Camera' table contains the following data:

| Channel                     | Channel Name | IP Address    | Model | Status | S/N        | Version    | Protocol | Port | Operation |
|-----------------------------|--------------|---------------|-------|--------|------------|------------|----------|------|-----------|
| <input type="checkbox"/> D1 | IC7          | 192.168.0.149 | IC7   | Online | CB25956260 | 2111042006 | ONVIF    | 6688 |           |
| <input type="checkbox"/> D2 | IC6          | 192.168.0.155 | IC6   | Online | null       | 2112071022 | ONVIF    | 6688 |           |
| <input type="checkbox"/> D3 | IC7          |               |       |        |            |            |          |      |           |
| <input type="checkbox"/> D4 | IT7          |               |       |        |            |            |          |      |           |

At the bottom left, there is a 'Show Pro Settings' button with a hand icon pointing to it.

## 4.6.2 Channel Management

On the channel management page, you can manage cameras and configure OSD display, image parameters, and video parameters.

### Camera Management

#### Overview

Navigate to **Configuration > Channel > Camera**.

You can manage cameras here, such as adding, editing or deleting cameras, upgrading camera software and viewing camera status.

- **Online Camera:** It displays the cameras currently in the same local area network as the NVR.
- **Added Camera:** It displays the cameras that have been successfully added to the NVR.

Auto add LAN cameras

Online Camera

| No.   | IP Address | Model | Status | S/N | Protocol | Port | Operation |
|-------|------------|-------|--------|-----|----------|------|-----------|
| Empty |            |       |        |     |          |      |           |

Add Manual



Added Camera Remaining Bandwidth: 59.0Mbps



| Channel                             | Channel Name | IP Address    | Model        | Status | S/N        | Version    | Protocol | Port | Operation |
|-------------------------------------|--------------|---------------|--------------|--------|------------|------------|----------|------|-----------|
| <input checked="" type="checkbox"/> | D1           | 192.168.0.140 | TD-L33DS1201 | Online | PC50739472 | 2111220953 | ONVIF    | 6688 |           |
| <input checked="" type="checkbox"/> | D2           | 192.168.0.149 | IC7          | Online | CB25956260 | 2111042006 | ONVIF    | 6688 |           |

Delete

#### Parameter & button description

| Parameter            | Description  |
|----------------------|--|
| Auto Add LAN Cameras | It specifies whether to enable the NVR to automatically add LAN cameras. Once it is enabled, the camera connected to the NVR can be discovered and added automatically within 2 minutes after the NVR is started. After 2 minutes, the camera can be discovered automatically and a prompt will be displayed through a pop-up window, and you can manually add it. |
| Online Camera No.    | It specifies the number of the camera.   |

| Parameter     | Description  |   |
|---------------|--|---|
| IP Address    | It specifies the IP address of the camera.   |   |
| Model         | It specifies the model of the camera.  |   |
| Status        | It specifies the status of the camera.<br><b>Online</b> indicates that the camera and the NVR are on the same LAN and the status is normal.  |   |
| S/N           | It specifies the S/N of the camera.<br>The system can only recognize the S/N of the camera that supports the private protocol of Tenda.  |   |
| Protocol      | It specifies the protocol supported by the camera.   |   |
| Port          | It specifies the port number of the protocol supported by the camera.  |   |
| Operation     | <p>It is used to perform operations for the camera:</p> <ul style="list-style-type: none"> <li>Click  to add the camera to the NVR.</li> <li>Click  to modify the network parameters of the camera (such as IP address and subnet mask), enable/disable the <b>Auto Add LAN Camera</b> (in the same LAN as the NVR) function, and reset the password of the camera.</li> </ul> <p> <b>NOTE</b></p> <ul style="list-style-type: none"> <li>The configuration item of different NVRs may differ. The actual product prevails.</li> <li>The <b>Auto Add LAN Camera</b> function only takes effect when the <a href="#">Auto add LAN cameras</a> function is enabled.</li> </ul> |   |
| <b>Add</b>    | It is used to add selected <b>Online Camera</b> in batches.<br>When cameras are added in batch, the system uses the user name and password of the admin account of the NVR to activate the cameras.  |   |
| <b>Manual</b> | It specifies you can add cameras by entering the IP address, protocol, port, user name, and password of the camera.<br>Generally used to add cameras that are not in the same LAN as the NVR.  |   |
| Added Camera  | Remaining Bandwidth  | It specifies the remaining bandwidth of the access bandwidth of the NVR (used for receiving the camera data). When the bandwidth is insufficient, the camera cannot be added. |
|               | Channel  | It specifies the channel number of the camera.  |

| Parameter           | Description   |
|---------------------|---|
| Channel name        | It specifies the channel name of the camera.  |
| IP address          | It specifies the IP address of the camera.  |
| Model               | It specifies the model of the camera.   |
| Status              | <p>It specifies the status of the camera.</p> <ul style="list-style-type: none"> <li>– <b>Connecting... (Logging in...):</b> It specifies the NVR is trying to log in to the camera.</li> <li>– <b>Online:</b> The camera is successfully added to the NVR, and you can view or manage the camera through the GUI of the NVR.</li> <li>– <b>Exception:</b> The NVR failed to add a camera. The detailed description is as follows. <ul style="list-style-type: none"> <li>• <b>Camera is offline:</b> The camera is not connected to the NVR. Ensure that the camera is working properly.</li> <li>• <b>Network is disconnected:</b> The network is disconnected between the camera and the NVR. Please ensure that the network is connected properly between the camera and the NVR, and the network parameters are configured correctly.</li> <li>• <b>Incorrect user name or password:</b> The user name or password of the camera is incorrect.</li> <li>• <b>The user has been locked:</b> The login account of the camera has been locked.</li> </ul> </li> </ul> |
| S/N                 | It specifies the serial number of the camera.   |
| Firmware Version    | It specifies the firmware version of the camera.  |
| Protocol            | It specifies the protocol used by the camera to connect to the NVR.   |
| Port                | It specifies the port number of the protocol used by the camera to connect to the NVR.  |
| Operation           | <p>It is used to perform operations for the camera:</p> <ul style="list-style-type: none"> <li>– Click  to modify the camera bound to the channel, such as IP address, protocol, and port.</li> <li>– Click  to delete the camera.</li> <li>– Click  to upgrade the firmware of the camera.</li> </ul>   |
| <span>Delete</span> | It is used to delete selected <b>Online Camera</b> in batches.  |

| Parameter | Description  |
|-----------|--|
| Upgrade   | It specifies you can upgrade the firmware for the selected camera. |

## Add Camera

The number of cameras that can be added varies with NVR models, and the actual product prevails. You can add cameras by following the operations below when the number of added cameras does not reach the upper limit.



- If you want to add other brand cameras, please connect the camera to the LAN where the NVR is located using an Ethernet cable.
- When adding cameras in the kit, please ensure that the cameras are in the factory settings. If not, please reset the camera first.
- If it is a camera in the wireless video security kit, the camera can be discovered and added automatically within 2 minutes after the NVR is started. After the NVR is working properly, the camera can be discovered automatically, and you need to add the camera manually.
- In the PoE video security kit, if the camera is connected to the PoE port of the NVR, the camera will be discovered and added by the system within 2 minutes.
- The number of cameras that can be added of different NVRs may differ. Please add cameras according to the actual situation.

## Add Cameras that are in the Same LAN as the NVR.

- Step 1** Connect the camera to the LAN where the NVR is located. If the Wi-Fi camera is included in the video security kit, place the camera within the coverage range of the NVR.
- Step 2** [Log in to the GUI of the NVR.](#)
- Step 3** Navigate to **Configuration > Channel > Camera.**
- Step 4** Find the **Online Camera** module, then add the camera.

Method 1:

Select the camera you want to add according to the S/N, and click **Add**.



If the user name and password of the camera to be added are different from the NVR, please add the camera by method 2.



Method 2:

1. Find the camera you want to add according to the S/N, then click ⊕ behind the camera.





2. Select the protocol of the camera, enter the port, user name and password, and click **Add**.

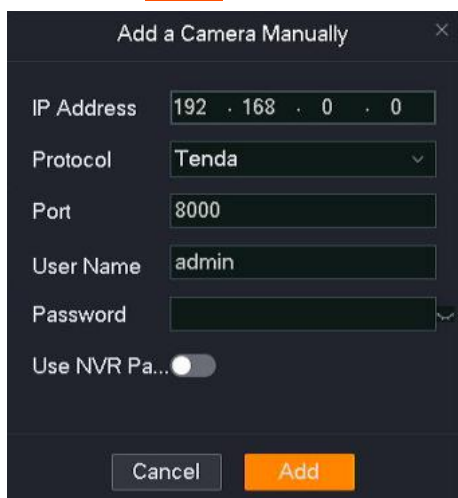

Dialog box titled "Add a Camera Manually" with the following fields:

- IP Address: 192 . 168 . 0 . 0
- Protocol: Tenda
- Port: 8000
- User Name: admin
- Password: (empty)
- Use NVR Pa...:

Buttons: Cancel, Add

3. If you want to add other cameras, repeat substeps 1 to 2.

---End

Wait a moment. The camera is added successfully. You can check the added camera in the **Added Camera** module.

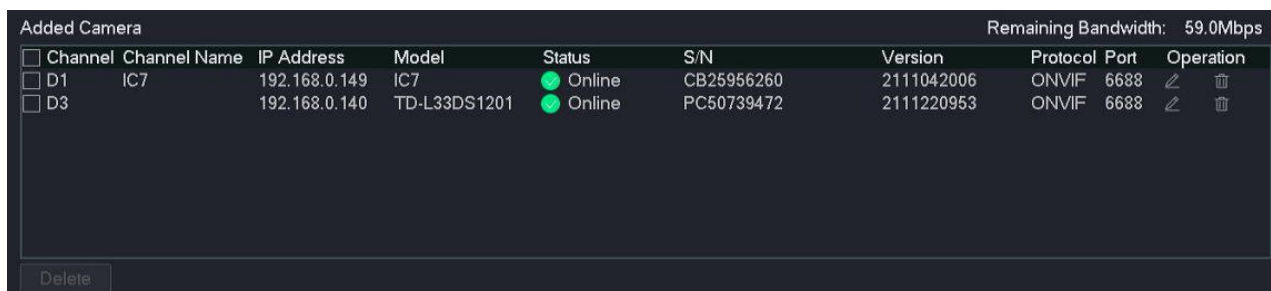

| Channel                     | Channel Name | IP Address    | Model        | Status                                      | S/N        | Version    | Protocol | Port | Operation |
|-----------------------------|--------------|---------------|--------------|---|------------|------------|----------|------|-----------|
| <input type="checkbox"/> D1 | IC7          | 192.168.0.149 | IC7          | <span style="color: green;">●</span> Online | CB25956260 | 2111042006 | ONVIF    | 6688 |           |
| <input type="checkbox"/> D3 |              | 192.168.0.140 | TD-L33DS1201 | <span style="color: green;">●</span> Online | PC50739472 | 2111220953 | ONVIF    | 6688 |           |

Remaining Bandwidth: 59.0Mbps

Delete

## Add Cameras that are not in the Same LAN as the NVR.

**Step 1** Connect the camera to a network that is routable to the NVR using an Ethernet cable.

**Step 2** [Log in to the GUI of the NVR.](#)

**Step 3** Navigate to **Configuration > Channel > Camera.**

**Step 4** Find the **Online Camera** module, and click **Manual**.

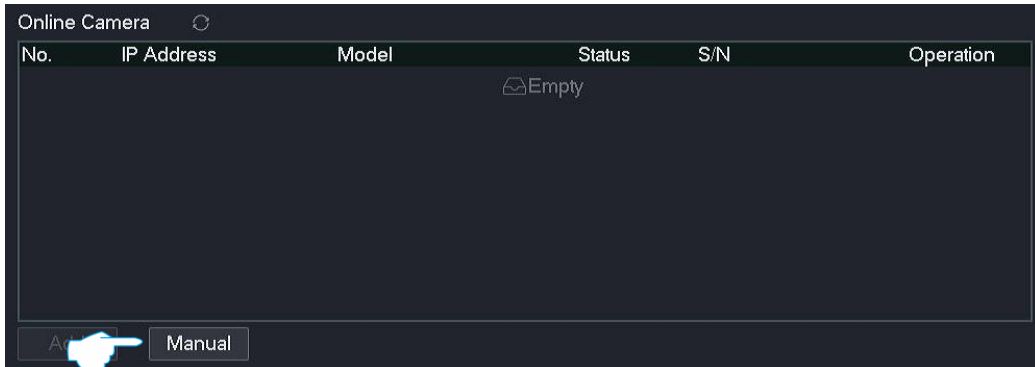

**Step 5** Enter the IP address of the camera, select the protocol of the camera, enter the port, user name and password, and click **Add**. (The parameters in the figure are for reference only.)













The screenshot shows the 'Add a Camera Manually' dialog box. It contains the following fields and values:

| Field      | Value               |
|------------|---------------------|
| IP Address | 192 . 168 . 8 . 201 |
| Protocol   | ONVIF               |
| Port       | 8000                |
| User Name  | admin               |
| Password   | [masked]            |

At the bottom of the dialog, there are two buttons: 'Cancel' and 'Add'.

**---End**

Wait a moment. The camera is added successfully. You can view the added camera in the **Added Camera** module.

| <input type="checkbox"/> | Channel | Channel Name | IP Address     | Model | Status | S/N            | Version       | Operation   |
|--------------------------|---------|--------------|----------------|-------|--------|----------------|---------------|---|
| <input type="checkbox"/> | D1      | Tenda IPC    | 10.251.251.114 | KCT6  | Online | TD123450035654 | V11.10.00.489 |    |
| <input type="checkbox"/> | D2      | Tenda IPC    | 10.251.251.153 | IC7   | Online | TD123450035653 | V11.10.00.489 |    |
| <input type="checkbox"/> | D3      | Tenda IPC    | 10.251.251.162 | IC7   | Online | TD123450035667 | V11.10.00.489 |    |
| <input type="checkbox"/> | D4      | Tenda IPC    | 192.168.8.201  | IT7   | Online | TD123450035666 | V11.10.00.489 |    |

### Upgrade Firmware of the Camera

The device can obtain new or more stable performance through a firmware upgrade.



- Before upgrading the camera firmware, ensure that the status of the camera is **Online**.
- After the camera firmware is upgraded successfully, the camera will automatically reboot and reconnect to the NVR.
- The NVR can recognize USB storage devices formatted as FAT32, exFAT and NTFS.

#### Method 1

It is applicable for the NVR that cannot be connected to the mouse and the USB storage device at the same time.

**Step 1** Visit [www.tendacn.com](http://www.tendacn.com) to download the latest upgrade firmware of the corresponding camera model, and unzip it to the root directory of the USB device.

**Step 2** [Log in to the GUI of the NVR.](#)

**Step 3** Navigate to **Configuration > Channel > Camera**.

**Step 4** Find the **Added Camera** module, and upgrade the firmware of the camera.

Method 1: It is applicable for upgrading the firmware of multiple cameras at the same time.

Find the cameras you want to upgrade according to the S/N, tick the camera channel number, and click **Upgrade**.



Method 2: It is applicable for upgrading the firmware of a single camera.

Find the camera you want to upgrade according to the S/N, and click  behind the camera.

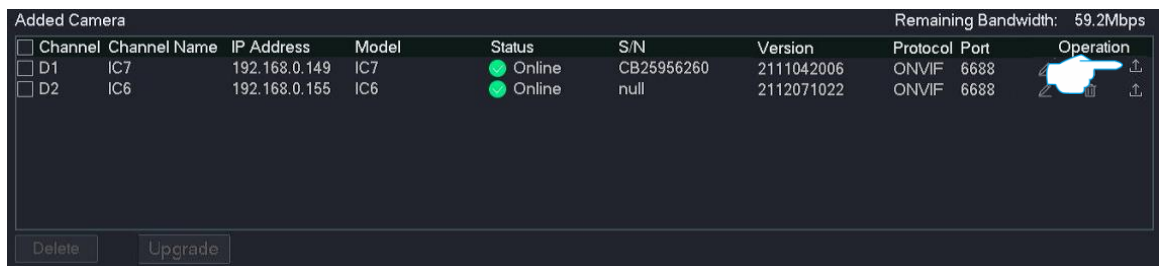

**Step 5** Unplug the mouse and insert the USB storage device with the upgrade file in the root directory within 1 minute. The camera will be upgraded automatically.

**---End**

After the upgrade completes, you can unplug the USB device.

## Method 2

It is applicable for the NVR that can be connected to the mouse and the USB storage device at the same time.



If the NVR has only one USB port or the USB port has been used, you need to prepare a USB hub by yourself.

- Step 1** Visit [www.tendacn.com](http://www.tendacn.com) to download the latest upgrade firmware of the corresponding camera model, and unzip it to the root directory of the USB device.
- Step 2** Connect the USB storage device to the USB port of the NVR.
- Step 3** [Log in to the GUI of the NVR.](#)
- Step 4** Navigate to **Configuration > Channel > Camera.**
- Step 5** Find the **Added Camera** module, and upgrade the firmware of the camera.

Method 1: It is applicable for upgrading the firmware of multiple cameras at the same time.

Find the cameras you want to upgrade according to the S/N, tick the camera channel number, and click **Upgrade**.

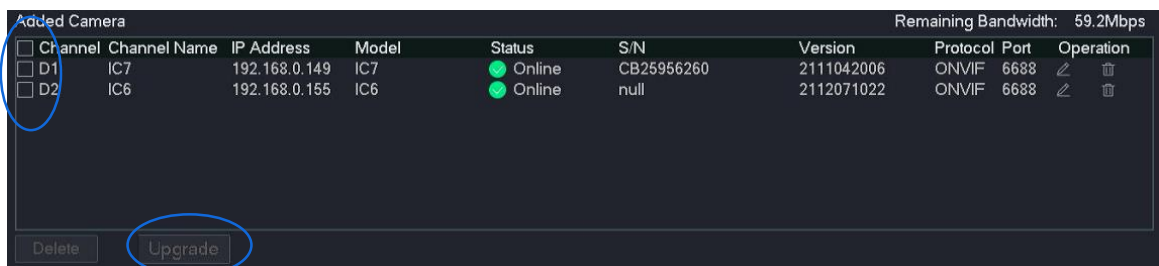

Method 2: It is applicable for upgrading the firmware of a single camera.

Find the camera you want to upgrade according to the S/N, and click behind the camera.

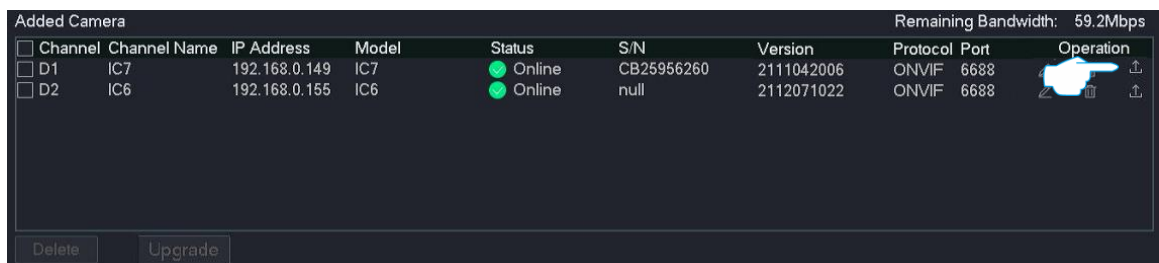

**Step 6** Select the USB device and upgrade file, and click **Upgrade**.

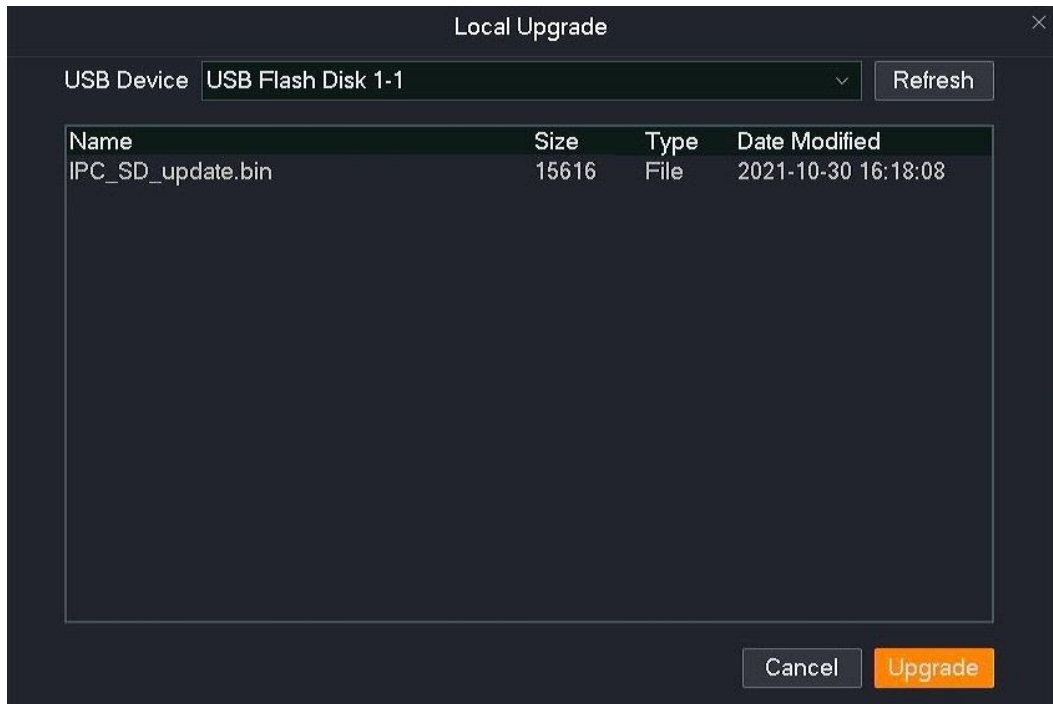

---End

# OSD Configuration

## Overview

Navigate to **Configuration > Channel > OSD**.

On-Screen Display (OSD) refers to displaying the required information on the screen. This refers to the information displayed on the screen overlaid with the monitoring image at the same time.

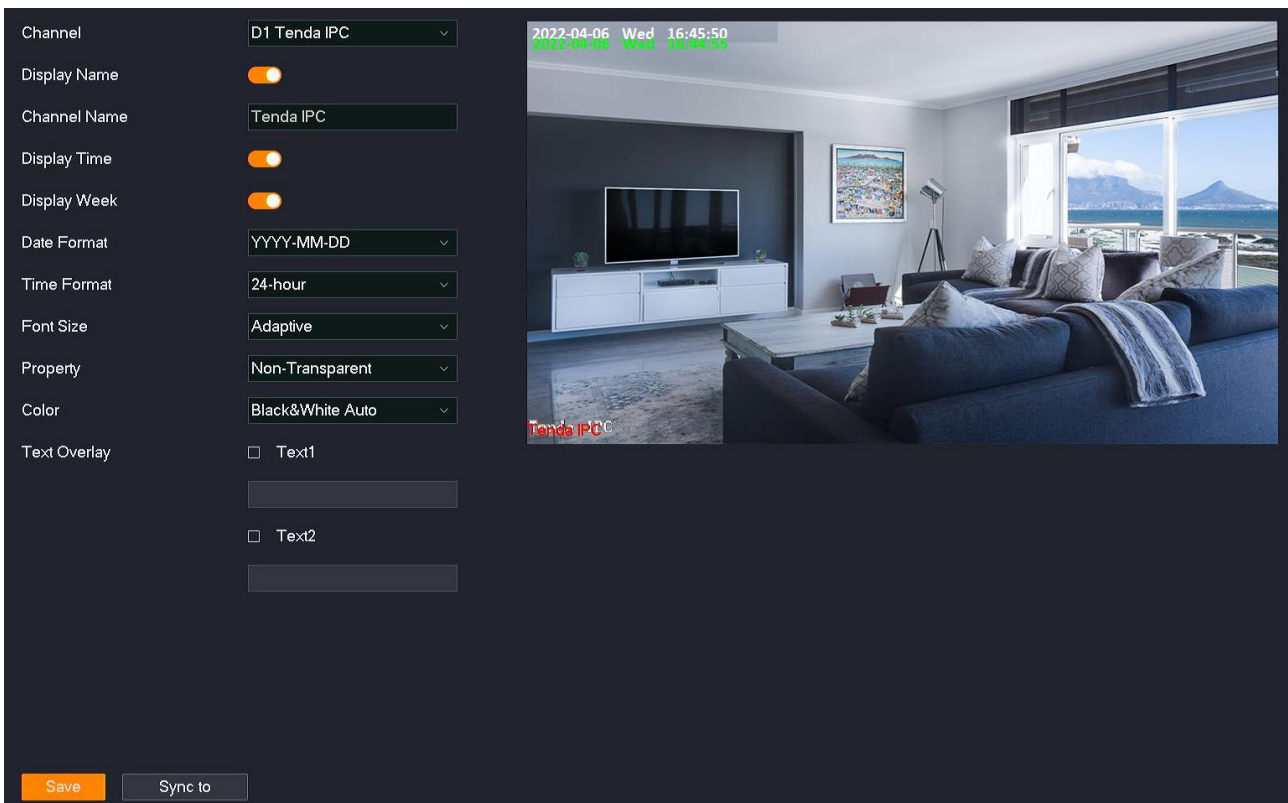

## Parameter description

| Parameter    | Description   |
|--------------|---|
| Channel      | It specifies the channel to be selected for OSD configuration.  |
| Display Name | It specifies the channel name can be displayed or hidden on the monitoring image.   |
| Channel Name | It specifies the channel name.<br>You are recommended to modify the channel name to the description of the installation position of the channel camera so that you can quickly locate each camera when managing multiple cameras. |
| Display Time | It specifies the system can be displayed or hidden on the monitoring image. It is available when the <b>Display Time</b> function is enabled.   |

| Parameter    | Description  |
|--------------|--|
| Display Week | It specifies the week can be displayed or hidden on the monitoring image. It is available when the <b>Display Time</b> function is enabled.  |
| Time Format  | It specifies the format of the specific time point. It is available when the <b>Display Time</b> function is enabled.  |
| Font Size    | It specifies the font size of the content displayed on the monitoring image. Such as channel name and system time.   |
| Property     | <p>It specifies the transparency of the content displayed on the monitoring image.</p> <p> <b>TIP</b></p> <p><b>Transparent</b> indicates a transparency of 50%.</p>  |
| Color        | It specifies the color of the content displayed on the monitoring image. Only Black&White Auto is supported for now. It indicates that the color is dark of the monitoring image, the displayed content will become white color. If the color is light of the monitoring image, the displayed content will become black. |
| Text Overlay | It specifies the displayed content is customized on the monitoring image.  |
| Sync to      | It is used to synchronize the OSD configuration parameters of the current channel to other channels.   |

## Modify OSD

Assume that the camera of D1 is installed in the living room, you can modify the channel name and location, time display format and location to manage the camera easily.

### Procedure:

- Step 1** [Log in to the GUI of the NVR.](#)
- Step 2** Click **Configuration > Channel > OSD**.
- Step 3** Set **Channel**, which is **D1** in this example.
- Step 4** Ensure that the **Display Name** function is enabled, and then modify the channel name, which is the **Living room** in this example.
- Step 5** Ensure that the **Display Time** and **Display Week** function are enabled, and then select the display date format and time format.
- Step 6** Click and drag the time shown in green and the channel name shown in red to the position you want to display in the live view window on the right (the following figure is for reference only).
- Step 7** Click **Save** at the bottom of the page.



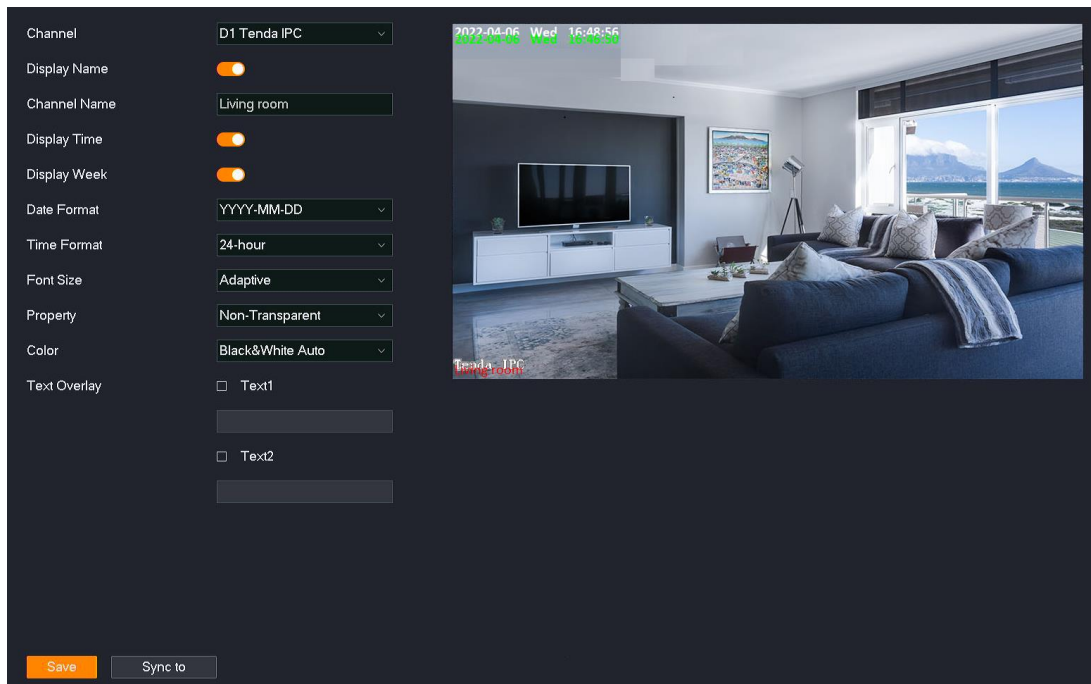

---End

After the setting completes, the channel name and position, system time display format and position of the camera D1 are the values currently set.

## Image Configuration

The N6P-4H is taken as an example here.

### Overview

Navigate to **Configuration > Channel > Image**. The N6P-4H is taken as an example here.

The image configuration function enables you to set such parameters as the image parameters, exposure, fill light and backlight to improve the visual effect of the camera monitoring image.

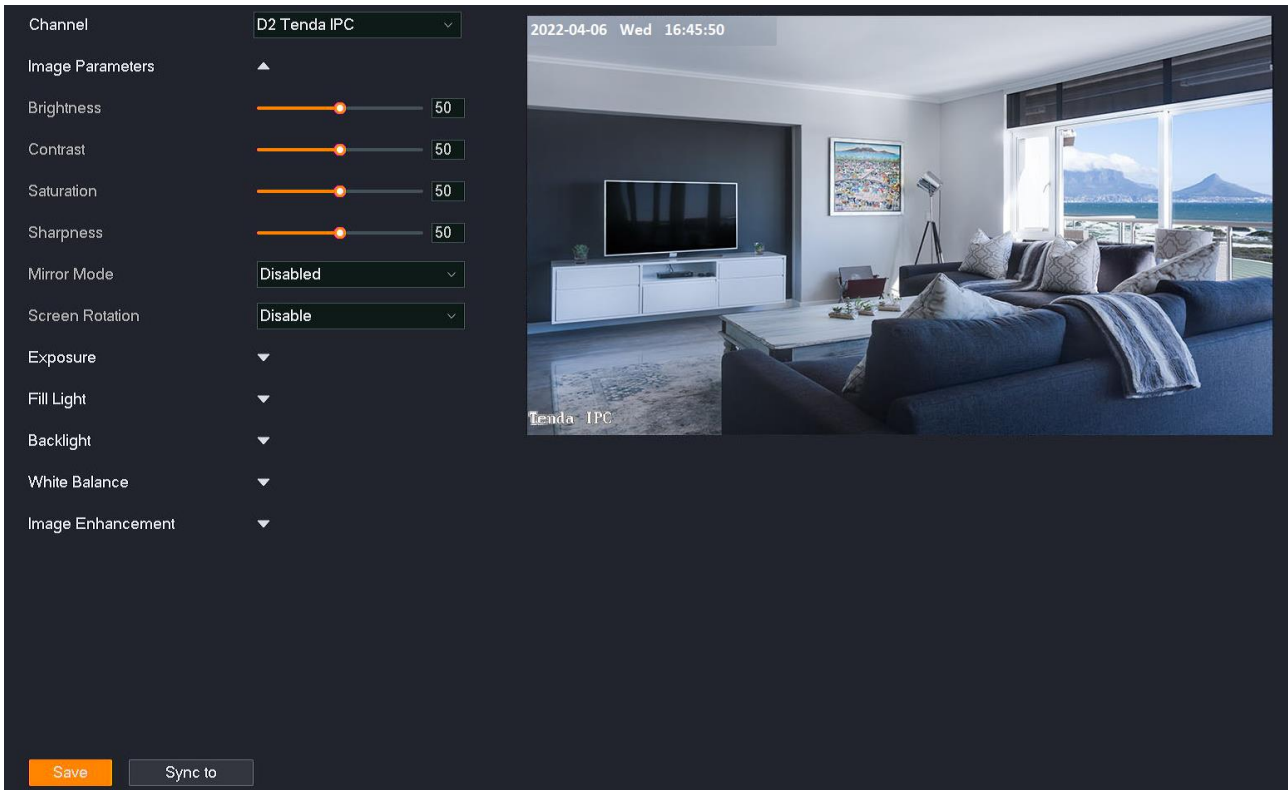

### Parameter description

| Parameter        | Description  |
|------------------|--|
| Channel          | It specifies the channel selected for adjusting the image parameters.  |
| Image Parameters | Image Style<br>It specifies the monitor image style. <b>Standard</b> , <b>Transparent</b> and <b>Soft</b> is supported for now.  |
|                  | Brightness<br>It specifies the brightness of the image.<br>The brightness value can be adjusted when the overall monitoring image is dark or bright. The larger the value, the brighter the image. |

| Parameter       | Description  |
|-----------------|--|
| Contrast        | <p>It specifies the ratio of the lightest area to the darkest area in the image.</p> <p>The contrast value can be adjusted when the sense of layering in the monitoring image is poor and the contrast between the white and black of the image is insufficient. The larger the value, the greater the contrast between the light and dark of the image.</p>   |
| Saturation      | <p>It specifies the vividness of the colors in the image. The larger the value, the more vivid the image color.</p>  |
| Sharpness       | <p>It specifies the sharpness of the edges of the image. The larger the value, the more obvious the edges of the image.</p>  |
| Mirror Mode     | <p>It specifies the direction of the monitoring image.</p> <ul style="list-style-type: none"> <li>– <b>Disable:</b> It specifies the image will not be mirrored.</li> <li>– <b>Up-Down:</b> It specifies the image will be reversed up and down.</li> <li>– <b>Left-Right:</b> It specifies the image will be reversed left and right.</li> <li>– <b>Center:</b> It specifies the image will be changed up and down, left and right. This mode can be selected when the camera is installed upside down.</li> </ul>  |
| Screen Rotation | <p>It specifies the rotation angle can be adjusted of the monitoring image.</p> <ul style="list-style-type: none"> <li>– <b>Disable:</b> It specified the image will not be rotated.</li> <li>– <b>Counterclockwise 90 Degrees:</b> It specifies the image will be rotated 90° to the left.</li> <li>– <b>Clockwise 90 Degrees:</b> It specifies the image will be rotated 90° to the right.</li> </ul>  |
| Exposure        | <p>It specifies the video image standard. <b>PAL (50 Hz)</b> and <b>NTSC (60 Hz)</b> is supported.</p> <ul style="list-style-type: none"> <li>– <b>PAL (50 Hz):</b> It specifies the PAL standard. The alternating current frequency is 50 Hz. It is suitable for such countries as China Mainland, China Hong Kong and the United Kingdom (U.K).</li> <li>– <b>NTSC (60 Hz):</b> It specifies the NTSC standard. The alternating current frequency is 60 Hz. It is suitable for such countries as China Taiwan, the United States, Japan and Canada.</li> </ul> |
| Anti-Flicker    | <p>It specifies the system sets the electronic shutter of the camera to an integer multiple or 0.5 times the light flickering frequency to prevent streaks in the image.</p> <p>You can enable this function if the monitoring image has streaks.</p>  |

| Parameter        | Description   |
|------------------|---|
| Exposure Mode    | <p>It specifies the exposure mode of the camera.</p> <ul style="list-style-type: none"> <li>– <b>Auto:</b> It specifies both gain and exposure time are automatic. The exposure time of the image sensor is adjusted according to the brightness of the environment light to get a clear image.</li> <li>– <b>Gain Priority:</b> It specifies the exposure time is automatically adjusted according to the manually adjusted gain, the camera can output standard images under different lighting conditions.</li> <li>– <b>Exposure Priority:</b> It specifies the gain is automatically adjusted according to the manually adjusted exposure time, the camera can output standard images under different lighting conditions.</li> <li>– <b>Manual:</b> It specifies both gain and exposure time can be adjusted manually.</li> </ul> <p> <b>TIP</b></p> <p>When the fill light mode is <b>Auto</b>, only <b>Auto</b> and <b>Exposure Priority</b> mode are supported.</p> |
| Mode             | <p>It specifies the day and night switching mode of the camera image.</p> <p><b>Auto Switch</b> is supported for now. It means that the camera automatically switches to day mode (the monitoring image is always in color) or night mode according to the environment brightness.</p>  |
| Day/Night Switch | <p>It specifies the camera monitoring image effect at night.</p> <ul style="list-style-type: none"> <li>– <b>Black &amp; white:</b> The infrared supplement light of the camera is enabled, and the monitoring image is always in black and white.</li> <li>– <b>Full Color:</b> The white supplement light of the camera is enabled, and the monitoring image is always in color.</li> <li>– <b>Smart:</b> When a moving object or human figure is detected, the white light of the camera will be enabled and the monitoring image will be in color, otherwise the infrared light will be enabled and the monitoring image will be in black and white.</li> </ul>   |
| Fill Light       | <p>It specifies the fill light mode.</p> <ul style="list-style-type: none"> <li>– <b>Auto:</b> It specifies the fill light can be automatically enabled according to the change of environment light brightness.</li> <li>– <b>Schedule:</b> It specifies the fill light can be enabled/disabled according to the preset time.</li> <li>– <b>Always on:</b> It specifies the fill light is always enabled.</li> <li>– <b>Always off:</b> It specifies the fill light is always disabled.</li> </ul>   |

| Parameter         | Description   |
|-------------------|---|
| Sensitivity       | <p>It specifies the light threshold of the fill light can be enabled automatically. Only available in the fill light mode is <b>Auto</b>.</p> <p>The higher the sensitivity, the smaller the light threshold that triggers the fill light, and the easier to enable the fill light.</p>   |
| Switch Delay      | <p>It specifies the extended time for enabling the fill light after the conditions are met. Only available when the fill light mode is <b>Auto</b>.</p>   |
| Smart IR          | <p>It is used to prevent the brightness of the fill light from being too high, causing overexposure of objects near the camera.</p> <ul style="list-style-type: none"> <li>– <b>Disable:</b> It specifies the <b>Smart IR</b> function of the fill light is disabled.</li> <li>– <b>Auto:</b> It specifies the fill light and the brightness of the image can be automatically adjusted to prevent the image from being overexposed.</li> <li>– <b>Manual:</b> It specifies the fill light and the brightness of the image can be manually adjusted to prevent the image from being overexposed.</li> </ul> |
| Disabled          | <p>It specifies the <b>Back Light Compensation (BLC)</b> function is disabled.</p>  |
| WDR               | <p>Wide Dynamic Range (WDR).</p> <p>When the high brightness area in the monitoring image contrasts with the low brightness area, the system weakens the high brightness area and brightens the low brightness area, so that both the bright part and the dark part can be seen clearly.</p>  |
| BLC               | <p>Back Light Compensation (BLC).</p> <p>It specifies the system exposes the <b>Compensation Area</b> to reach the appropriate brightness to ensure the clarity of the image.</p>   |
| HLC               | <p>Highlight Compensation (HLC).</p> <p>It specifies in a strong light environment, the system will weaken the strong light area and brighten the dark light area to achieve light balance and make the whole image clearer.</p>  |
| Level             | <p>It specifies the level of <b>WDR</b> or <b>HLC</b>. The higher the level, the more obvious the effect.</p>   |
| Compensation Area | <p>It specifies the area to be exposed. Only available when backlight mode is <b>BLC</b>.</p>   |

| Parameter               | Description  |
|-------------------------|--|
| White Balance /         | <p>It specifies the overall color of the image can be adjusted by setting the white balance mode.</p> <ul style="list-style-type: none"> <li>- <b>Auto:</b> It specifies the image color can be automatically adjusted according to the environment color temperature to restore the true color.</li> <li>- <b>Manual:</b> It specifies R gain and B gain can be manually adjusted to adjust the image color.</li> <li>- <b>Lock:</b> It specifies the current color temperature is locked.</li> <li>- <b>Fluorescent:</b> It specifies the color of the image can be adjusted according to the color temperature of the fluorescent light.</li> <li>- <b>Incandescent:</b> It specifies the color of the image can be adjusted according to the color temperature of the incandescent light.</li> <li>- <b>Warm:</b> It specifies the color of the image can be adjusted according to the color temperature of the warm light.</li> <li>- <b>Natural:</b> It specifies the color of the image can be adjusted according to the color temperature of the natural light.</li> </ul> |
|                         | <p>It specifies the image noise reduction.</p> <p>3D Noise Reduction<br/>Compare the images of the two frames before and after, target the noise location and handle noise reduction to make the image clearer and more delicate.</p>  |
| Image Enhancement Level | <p>It specifies the level of the 3D noise reduction.</p> <p>The higher the level, the more noise locations are handled by noise reduction.</p> <p> <b>NOTE</b></p> <p>If the noise reduction level is too high, the image may be distorted or blurred.</p>  |
| Sync to                 | <p>It is used to synchronize the image configuration parameters of the current channel to other channels.</p>  |

## Adjust Camera Image Parameters

If the monitoring images of D1, D2, D3 and D4 are not clear on the **Live View** page, you can try to adjust the image parameters of the camera.

### Procedure:

**Step 1** [Log in to the GUI of the NVR.](#)

**Step 2** Navigate to **Configuration > Channel > Image.**

**Step 3** Adjust the image parameters of the camera D1.

1. Select **Channel**, which is **D2** in this example.
2. Modify the relevant parameters such as **Brightness**, **Contrast**, **Exposure**, **Backlight** and **Fill Light** according to the live view effect of the image on the right.

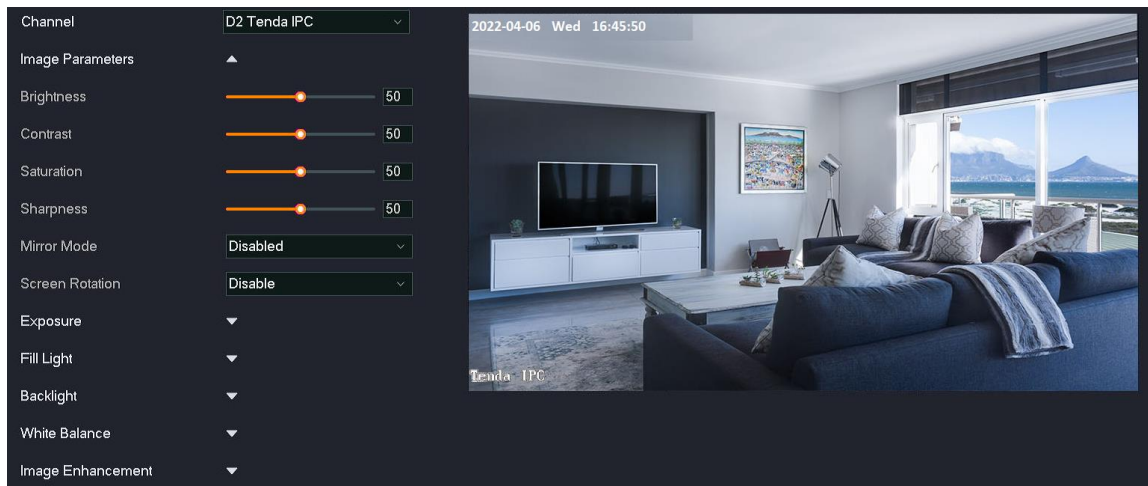

**Step 4** Adjust the image parameters of other channel cameras.

Click **Sync to** at the bottom of the page, and select the channel to synchronize the image parameter configuration of the D2 camera, which is **D1**, **D3** and **D4** in this example.

**Step 5** Click **Save**.

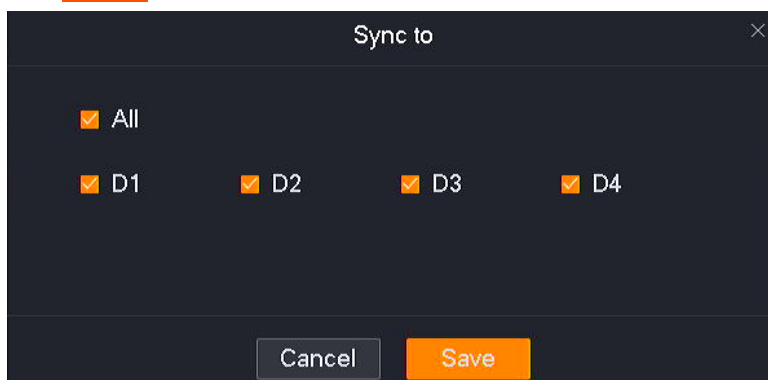

---End

## Set Night Vision Mode of the Camera

Only available in some models of NVR. The actual product prevails.

Assume that you want the monitoring images of D1, D2, D3, and D4 cameras to be colored during the day and night, you can modify the night vision mode of the cameras.

### Procedure:

**Step 1** [Log in to the GUI of the NVR.](#)

**Step 2** Navigate to **Configuration > Channel > Image.**

**Step 3** Set the night vision mode of the D1 camera.

1. Select **Channel**, which is **D1** in this example.
2. Click the drop-down list of **Night Vision Mode** to modify the night vision mode, which is **Full Color** in this example.



**Step 4** Adjust the night vision mode of other channel cameras.

Click **Sync to** at the bottom of the page, and select the channel to synchronize the image parameter configuration of the D1 camera, which is **D2 to D4** in this example.

**Step 5** Click **Save**.

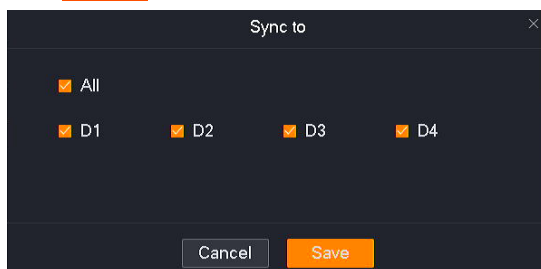

---End

After the setting completes, the monitoring images of D1, D2, D3 and D4 cameras are in color during the day. The white supplement light is enabled at night so that the monitoring images are also in color.



## Audio and Video Configuration

The N6P-4H is taken as an example here.

Navigate to **Configuration > Channel > Audio & Video**.

The audio and video configuration function enables you to adjust the video encoding or audio encoding parameters.

Some NVRs support the configuration of the **Stream Adaptive** function, and the system automatically adjusts video encoding parameters according to Wi-Fi network conditions. If you want to manually adjust the video encoding parameters, disable the **Stream Adaptive** function.

| Video Configuration |                  |
|---------------------|------------------|
| Main Stream         | Sub-stream       |
| Encoding Type       | Encoding Type    |
| H.265               | H.265            |
| Resolution          | Resolution       |
| 4M(2560*1440)       | NHD(640*360)     |
| Frame Rate          | Frame Rate       |
| 25 fps              | 25 fps           |
| Smart Encoding      | Smart Encoding   |
| Disable             | Disable          |
| Bitrate Type        | Bitrate Type     |
| Constant            | Constant         |
| Video Quality       | Video Quality    |
| Medium              | Medium           |
| Bitrate             | Bitrate          |
| 8192 Kbps           | 2048 Kbps        |
| I Frame Interval    | I Frame Interval |
| 50                  | 50               |

| Audio Configuration |                                     |
|---------------------|-------------------------------------|
| Audio Stream        | <input checked="" type="checkbox"/> |
| Encoding Type       | G711A                               |
| Sampling Rate       | 16 kHz                              |
| Bit Depth           | 16 bit                              |
| Volume              | 50                                  |

## Parameter description

| Parameter           | Description   |
|---------------------|---|
| Channel             | It specifies the channel chosen to adjust image parameters.   |
| Stream Adaptive     | It specifies whether the <b>Stream Adaptive</b> function is enabled. When it is enabled, the system automatically adjusts the resolution and bit rate according to changes in the network environment.  |
| Video Configuration | They specify the stream types of the video. <ul style="list-style-type: none"> <li>– <b>Main stream:</b> The stream has a large value and a high occupied bandwidth, which is applicable for large-screen monitoring and storage.</li> <li>– <b>Sub-stream:</b> The stream has a small value and a small occupied bandwidth, which is applicable for small-screen monitoring and network transmission.</li> </ul>   |
|                     | It specifies the encoding standard of the video. <ul style="list-style-type: none"> <li>– <b>H.264 (H.264M):</b> A generation of highly compressed video codec standards after MPEG4, which improves compression efficiency under the same video quality.</li> <li>– <b>H.265:</b> A generation of video coding standards after H.264, which improves the bit stream, coding quality, delay to optimize coding and save more bandwidth and capacity under the same video quality.</li> </ul> <p> <b>TIP</b></p> <p>Different cameras support different encoding standards. The actual page prevails.</p> |
| Resolution          | It specifies the number of pixels contained in a frame of an image. The higher the resolution, the clearer the image and the more obvious details.  |
| Frame Rate          | It specifies the number of video frames displayed per second. The higher the frame rate, the smoother the image.  |
| Smart Encoding      | H.264+ and H.265+ encoding standards are adopted, which is an optimization compared to H.264 and H.265.<br>It specifies the smart encoding function can be enabled to maximize compression efficiency, expand storage time and save HDD capacity while ensuring image quality.  |

| Parameter           | Description   |
|---------------------|---|
| Video Configuration | <p>It specifies the bit rate control method of the video.</p> <ul style="list-style-type: none"> <li>– <b>Fixed:</b> The fixed bitrate tries to encode according to the upper limit of the bit rate, and the bit rate will fluctuate up and down in the <b>bit rate value</b>, and will not change with the monitoring scene.</li> <li>– <b>Variable:</b> The bit rate will change with the monitoring scene. Adopt a high bit rate when the monitoring scene is moving or changing. The variable bitrate adopts a lower bit rate when the monitoring scene is static.</li> </ul> |
|                     | <p>It specifies the level of the image quality. Please select it according to the actual condition.</p>   |
|                     | <p>It specifies the size of the video data per unit time. The larger the bit rate, the better the picture quality.</p>  |
|                     | <p>It specifies the number of normal frames between two I-frames (keyframe).</p>  |
| Audio Configuration | <p>It specifies whether to enable the <b>Audio Stream</b> function.</p> <ul style="list-style-type: none"> <li>– <b>Enable:</b> It specifies the recording file is audio and video composite stream.</li> <li>– <b>Disable:</b> It specifies the recording file is a video stream, and no audio stream.</li> </ul>  |
|                     | <p>It specifies the encoding standard of the audio. Please select it according to the actual condition.</p>   |
|                     | <p>It specifies the number of audio samples collected per second.</p> <p> <b>TIP</b></p> <p>It can be set only when the encoding type is <b>AAC</b>.</p>   |
|                     | <p>It specifies the number of bits of information in each sample.</p>   |
|                     | <p>It specifies the volume level of the camera input audio.</p>   |

# Privacy Mask

## Overview

Navigate to **Configuration > Channel > Privacy Mask**.

The privacy shutter function enables you to set **Privacy Mask** area, and the area cannot be displayed in the monitoring image. It is used for masking sensitive or private areas.

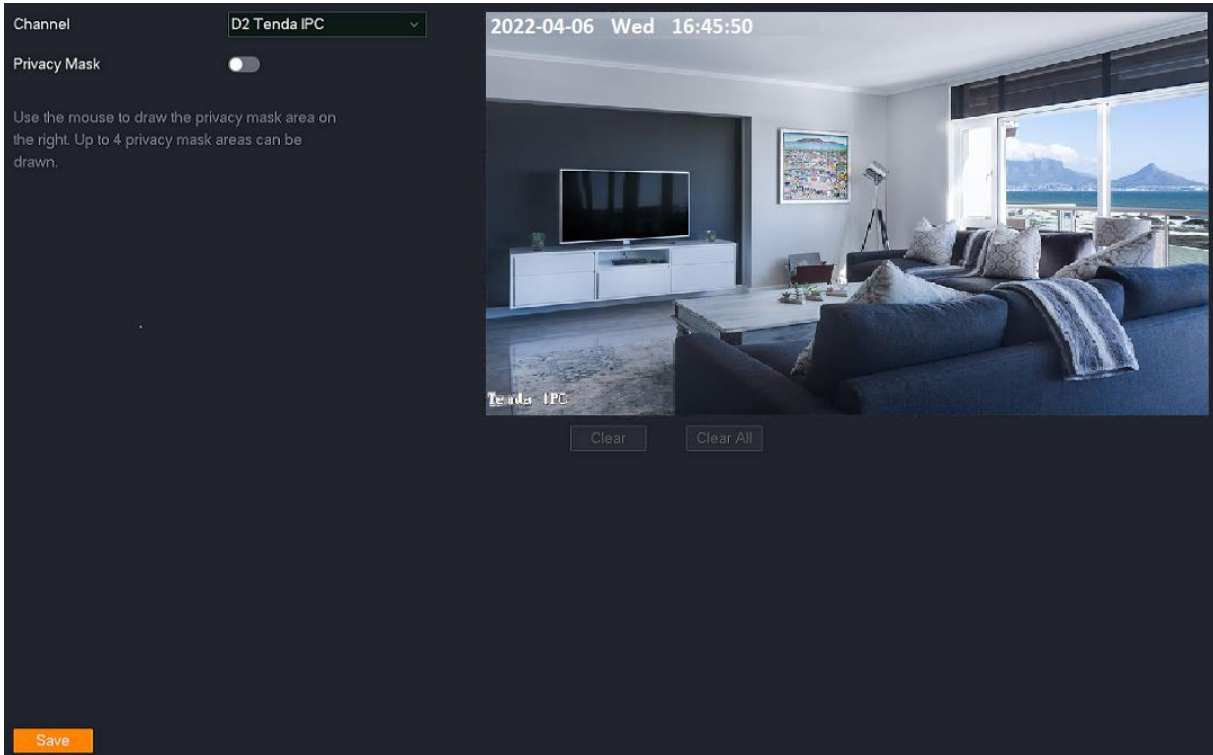

## Parameter description

| Parameter    | Description  |
|--------------|--|
| Channel      | It specifies the channel you want to set as a privacy mask area.                     |
| Privacy Mask | It specifies whether to enable the <b>Privacy Mask</b> function.                     |
| Mask Area    | It specifies the privacy area can be drawn through the mouse in the monitoring area. |
| Clear        | It is used to clear the selected mask area.  |
| Clear All    | It is used to clear the current mask area.   |

## Set Privacy Mask

**Scenario:** Assume that you have set up a monitoring network with the NVR, and the camera D1 is installed in the living room.

**Requirement:** You want to hide the privacy area in the monitoring image.

**Solutions:** Configure the **Privacy Mask** functions to meet this requirement.

### Procedure:

**Step 1** [Log in to the GUI of the NVR.](#)

**Step 2** Navigate to **Configuration > Channel > Privacy Mask.**

**Step 3** Select **Channel**, which is **D1** in this example.

**Step 4** Set **Privacy Mask** to , and use the mouse to draw a privacy area in the monitoring area on the right (The figure is for reference only.)

**Step 5** Click **Save** at the bottom of the page.

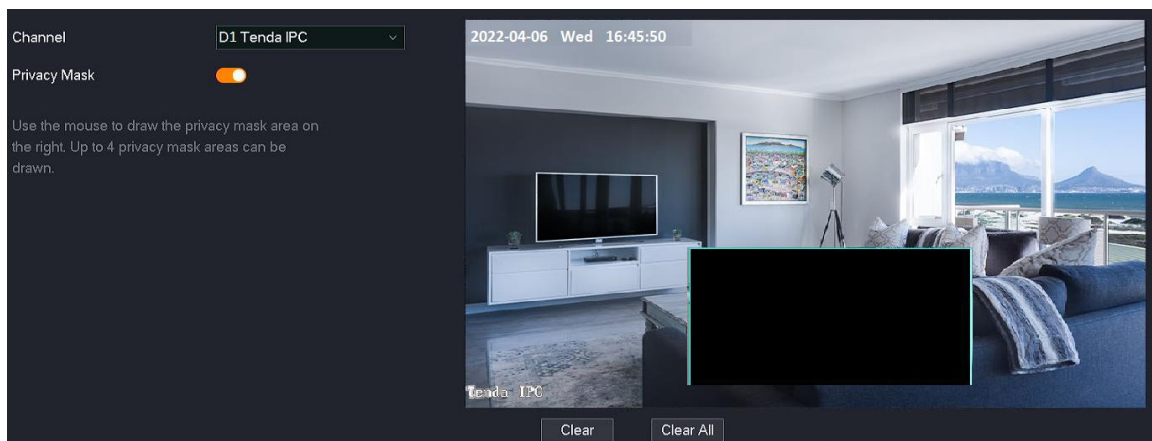

---End

Settings completed. The **Privacy Mask** area will not be displayed on the monitoring image.

# Auto Maintenance

## Overview

Navigate to **Configuration > Channel > Auto Maintenance**.

You can perform maintenance operations for the camera, such as reboot, scheduled reboot, reset to default settings and restore to default settings.

## Reboot

The reboot can prevent the camera from running for a long time, which may cause its performance to degrade and become unstable. You can reboot the camera immediately according to the actual condition.

### Procedure:

- Step 1** [Log in to the GUI of the NVR.](#)
- Step 2** Navigate to **Configuration > Channel > Auto Maintenance**.
- Step 3** Select the channel of the camera to be rebooted, which is **D1** in this example.
- Step 4** Click **Reboot**.

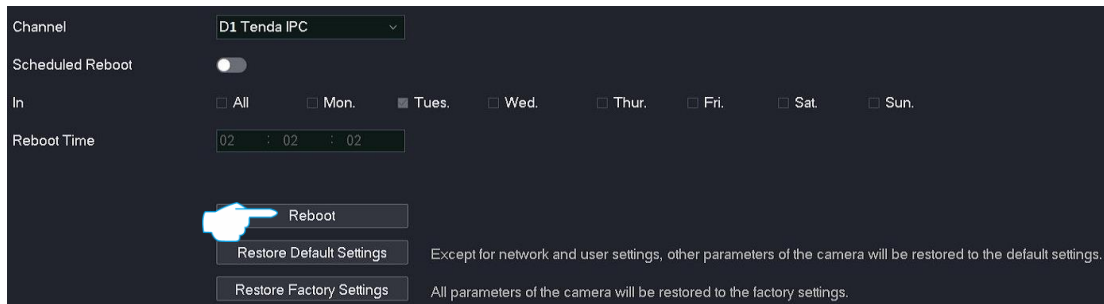

- Step 5** Read the prompt message, and click **OK**.

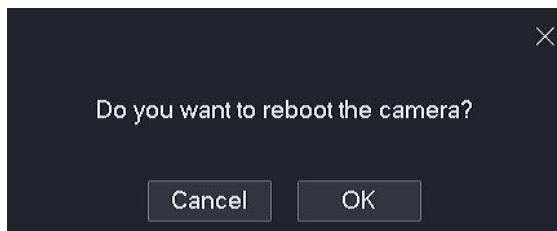

**---End**

Settings completed. The camera D1 will be rebooted now.

## Scheduled Reboot

The reboot can prevent the camera from running for a long time, which may cause its performance to degrade and become unstable. You can set the router to reboot periodically during leisure time. For example, you want to set the camera to reboot automatically at 3:00:00 from Monday to Friday.

### Procedure:

**Step 1** [Log in to the GUI of the NVR.](#)

**Step 2** Navigate to **Configuration > Channel > Auto Maintenance.**

**Step 3** Select the channel of the camera to be rebooted, which is **D1** in this example.

**Step 4** Set **Scheduled Reboot** to .

**Step 5** Select the reboot dates, which is **Monday to Friday** in this example.

**Step 6** Set the reboot time, which is **3:00:00** in this example.

**Step 7** Click  at the bottom of the page.

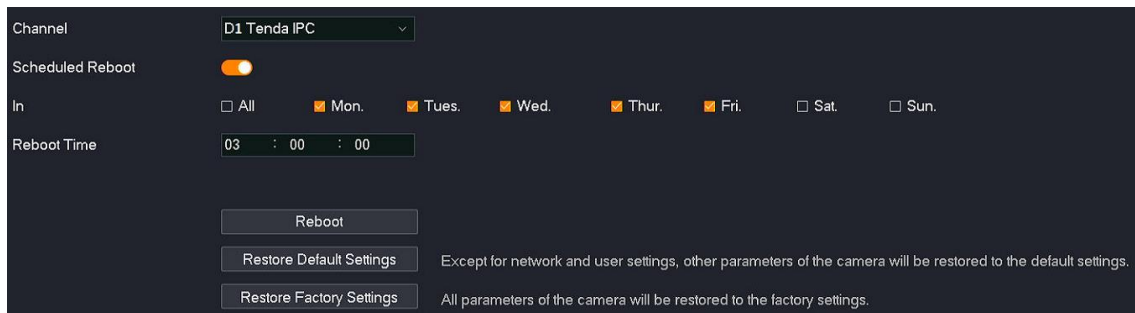

Channel: D1 Tenda IPC

Scheduled Reboot:

In:  All  Mon.  Tues.  Wed.  Thur.  Fri.  Sat.  Sun.

Reboot Time: 03 : 00 : 00

Reboot

Restore Default Settings

Restore Factory Settings

Except for network and user settings, other parameters of the camera will be restored to the default settings.

All parameters of the camera will be restored to the factory settings.

---End

Settings completed. The camera D1 will be rebooted automatically at 3:00:00 from Monday to Friday.

## Restore Settings

If the NVR is running slowly, or a configuration error occurs, you can try to restore the NVR.

- Restore the default settings: Except for the network configuration and user management-related configuration, all other settings are restored to the factory settings.
- Restore factory settings: Restore all settings of the NVR to the factory settings.

 NOTE

- When the NVR restores its settings, it will disconnect all current connections.
- Restoring the settings will not delete recordings and log information.
- To avoid damaging the NVR, ensure that the NVR is powered on properly during the process of restoring the factory settings.

**Procedure:**

**Step 1** [Log in to the GUI of the NVR.](#)

**Step 2** Navigate to **Configuration > Maintenance > Auto Maintenance.**

**Step 3** Select the channel of the camera to be rebooted, which is **D1** in this example.

**Step 4** Click  or  according to the actual condition.

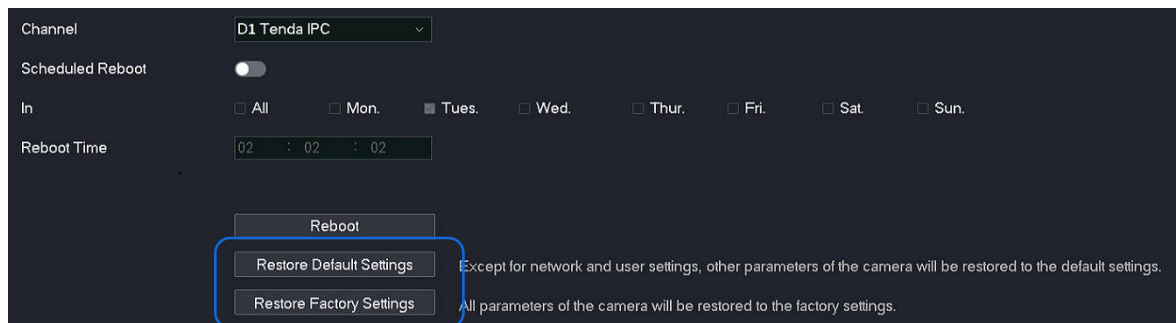

**Step 5** Read the prompt message, and click .

**---End**

Wait until the progress bar completes.



## 4.6.3 Storage Management

On the storage management page, you can manage the Hard Disk Driver (HDD) and set recording schedules.

### HDD Management

#### Overview

Navigate to **Configuration > Storage > HDD**.

You can check HDD status, format HDD and set storage policy when the HDD is full.

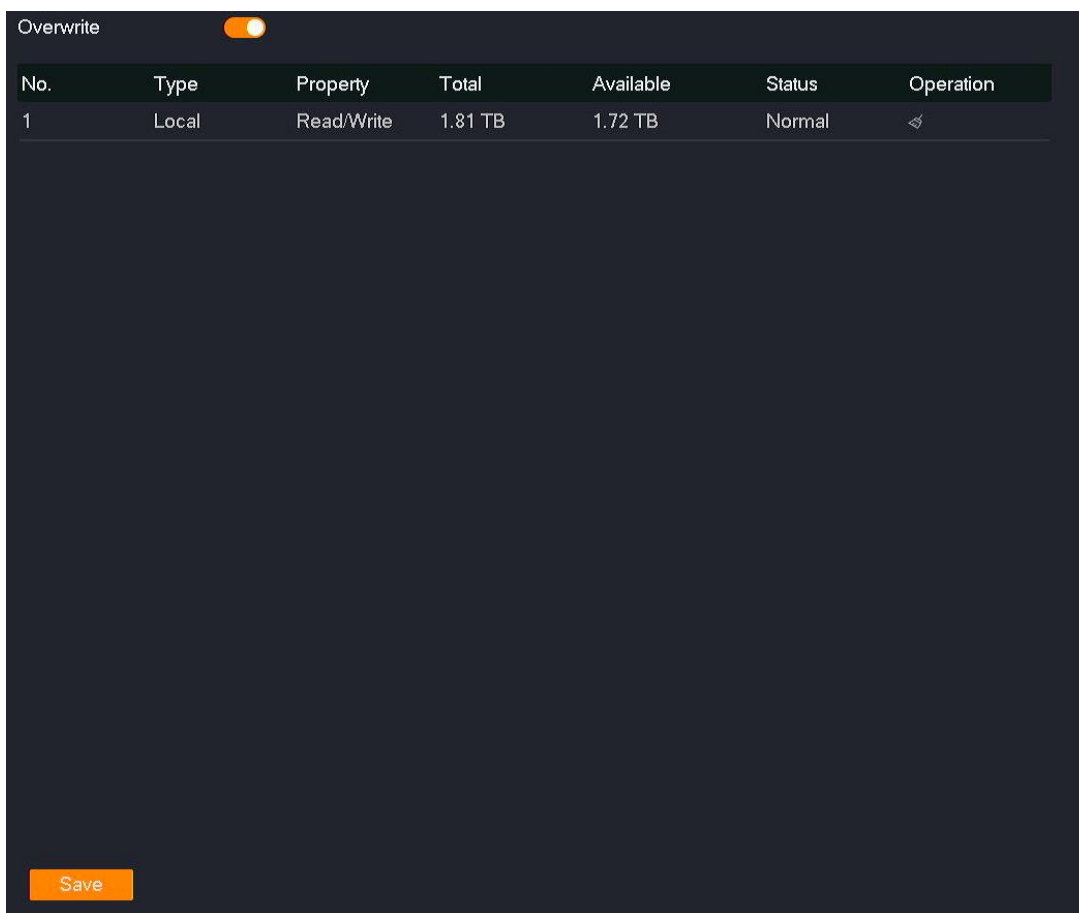

Overwrite

| No. | Type  | Property   | Total   | Available | Status | Operation   |
|-----|-------|------------|---------|-----------|--------|---|
| 1   | Local | Read/Write | 1.81 TB | 1.72 TB   | Normal |  |

Save

#### Parameter description

| Parameter | Description  |
|-----------|--|
| Overwrite | It specifies storage policy when HDD space is full.<br>After it is enabled, if the HDD is full, the oldest recording files will be overwritten cyclically. |
| No.       | It specifies the number of the HDD.  |

| Parameter | Description   |
|-----------|---|
| Type      | It specifies the type of HDD. <b>Local</b> is supported for now, which means that the HDD is installed inside the NVR.  |
| Property  | It specifies the property of the HDD and cannot be modified for now.  |
| Total     | It specifies the total capacity of the HDD.   |
| Available | It specifies the available capacity of the HDD.   |
| Status    | <p>It specifies the status of the HDD.</p> <p>If the HDD is abnormal. Try the following solutions:</p> <ul style="list-style-type: none"> <li>– Please shut down the NVR first, reinstall the HDD and start up the NVR.</li> <li>– If the problem persists, please format the HDD.</li> </ul>   |
| Operation | <p>It is used to format the HDD.</p> <p> <b>NOTE</b></p> <ul style="list-style-type: none"> <li>– All data will be cleared and cannot be restored after the HDD is formatted. Please operate with caution.</li> <li>– If the formatting fails, please try again. If the problem persists, please shut down the NVR first, replace the HDD and start up the NVR.</li> </ul> |

### Check HDD Status and Available Capacity

[Log in to the GUI of the NVR](#), then navigate to **Configuration > Storage > HDD** to check HDD information, such as status and available capacity.

| No. | Type  | Property   | Total   | Available | Status | Operation   |
|-----|-------|------------|---------|-----------|--------|---|
| 1   | Local | Read/Write | 1.81 TB | 1.72 TB   | Normal |  |

## Format HDD

If the **Status** of the NVR is abnormal, or you want to clear the data of the HDD, you can format the HDD.



- All data will be cleared and cannot be restored after the HDD is formatted. Please operate with caution.
- If the formatting fails, please try again. If the problem persists, please shut down the NVR first, replace the HDD and start up the NVR.

### Procedure:

**Step 1** [Log in to the GUI of the NVR.](#)

**Step 2** Navigate to **Configuration > Storage > HDD.**

**Step 3** Click the format button .

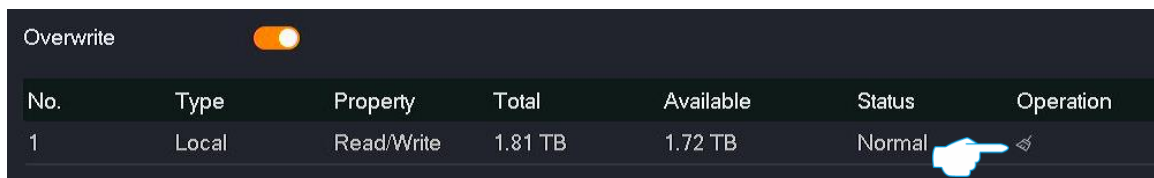

**Step 4** Read the prompt message, and click **OK**.

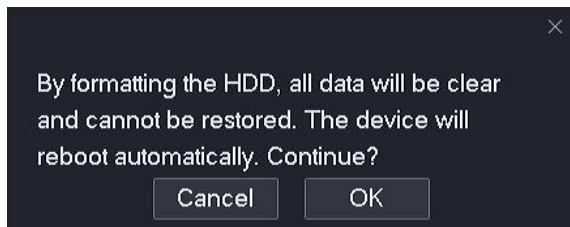

**---End**

The system will format the HDD.

# Schedule

## Overview

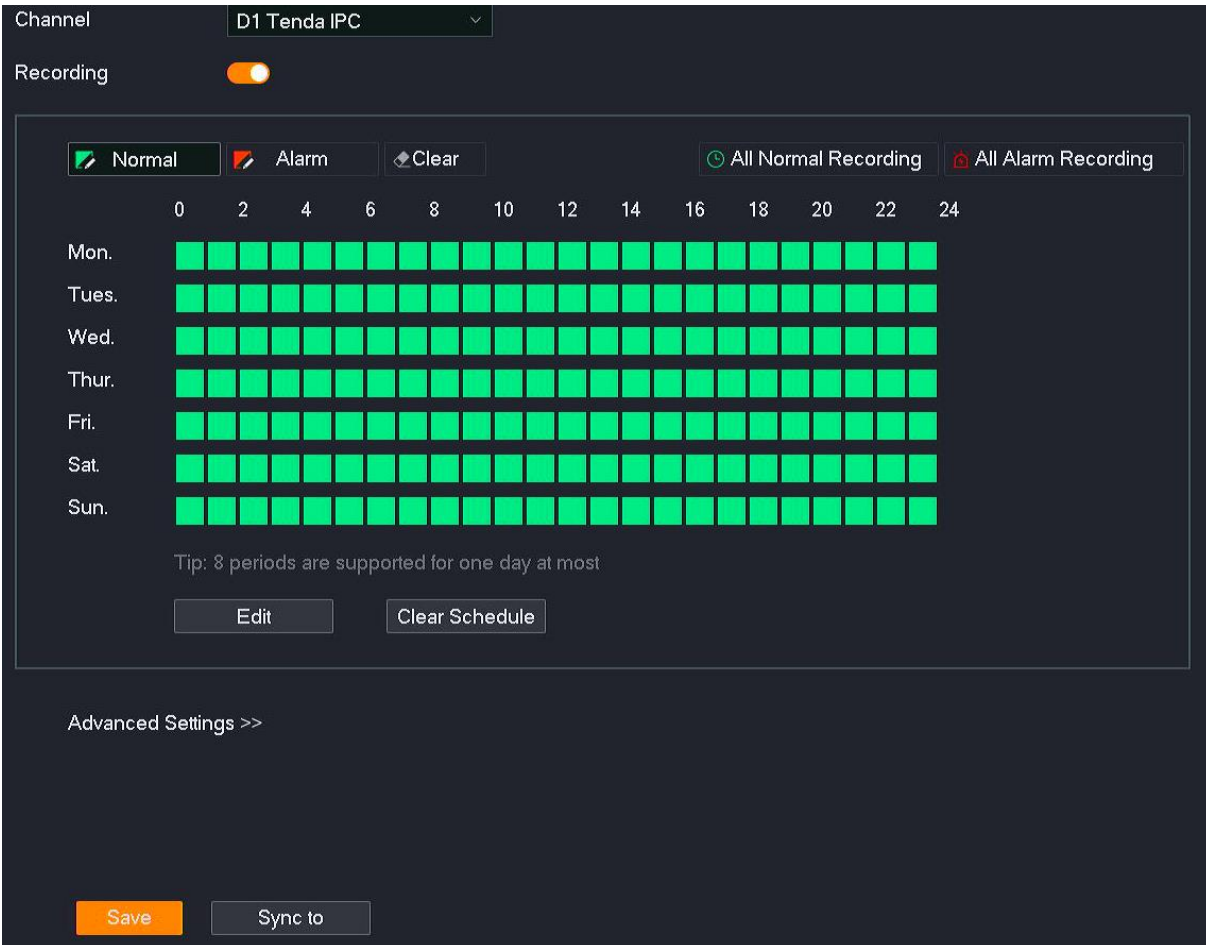

Navigate to **Configuration > Storage > Schedule**.

After the schedule is set, the system will record according to the schedule. By default, the system presets the schedule of 24 hours continuous normal recording for each channel, and you can modify the recording time and recording type as required.

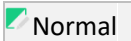

### Parameter & button description

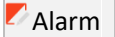
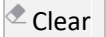
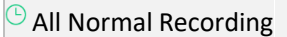
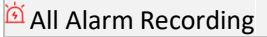
| Parameter  | Description   |
|--|---|
| Channel  | It specifies the channel chosen to set the schedule.  |
| Recording  | It specifies whether the recording function is enabled.   |
|  Normal | Green means normal recording. It specifies the NVR always records. Click this button to draw the recording time in the timetable below. |

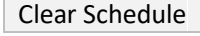
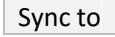
| Parameter  | Description  |
|--|--|
|  Alarm                | Red means alarm recording. It specifies the NVR will record only when the camera triggers an alarm. Click this button to draw the recording time in the timetable below. |
|  Clear                | It is used to clear the time that has been set in the timetable below.<br>Click this button to clear the recording time in the timetable below.                          |
|  All Normal Recording | It is used to set a 24-hour normal recording from Monday to Sunday with one click.   |
|  All Alarm Recording  | It is used to set a 24-hour alarm recording from Monday to Sunday with one click.  |
|  Edit                 | It is used to edit the schedule for a specific time in detail.   |
|  Clear Schedule       | It is used to clear the current recording schedule.  |
|  Sync to              | It is used to synchronize the current schedule to other channels.  |
| Post-record  | Only applicable for <b>Alarm</b> . Click <b>Advance</b> to enter the page.<br>It specifies the time of continuous recording after an alarm is finished.                  |

## Configure Schedule

Assume that you want to set a schedule for D1, D2, D3, and D4 cameras as shown in the table below:

| Recording        | Recording Time | Recording Type   |
|------------------|----------------|------------------|
| Monday to Sunday | 00:00 to 8:00  | Not recording    |
| Monday to Sunday | 8:00 to 12:00  | Alarm recording  |
| Monday to Sunday | 12:00 to 14:00 | Normal recording |
| Monday to Sunday | 14:00 to 18:00 | Alarm recording  |
| Monday to Sunday | 18:00 to 24:00 | Normal recording |



After an alarm recording plan is set for the corresponding channel, the alarm event also needs to be set for the channel in the [Alarm Management](#).

## Method 1

**Step 1** [Log in to the GUI of the NVR.](#)

**Step 2** Navigate to **Configuration > Storage > Schedule.**

**Step 3** Set the schedule of the camera D1.

1. Set **Channel**, which is **D1** in this example, and enable the **Recording** function.
2. Click **Clear Schedule**.

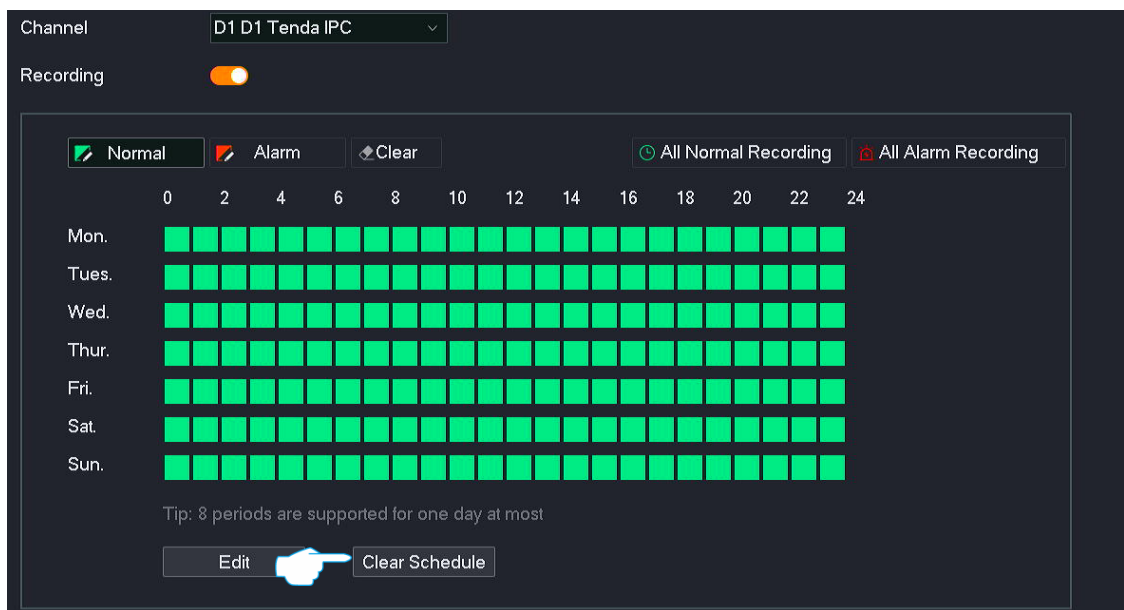

3. Click  Normal, then hold down the left mouse and drag to draw the recording period, which is **12:00 to 14:00** and **18:00 to 24:00** from **Monday to Sunday** in this example.
4. Click  Alarm, then hold down the left mouse and drag to draw the recording period, which is **8:00 to 12:00** and **14:00 to 18:00** from **Monday to Sunday** in this example.

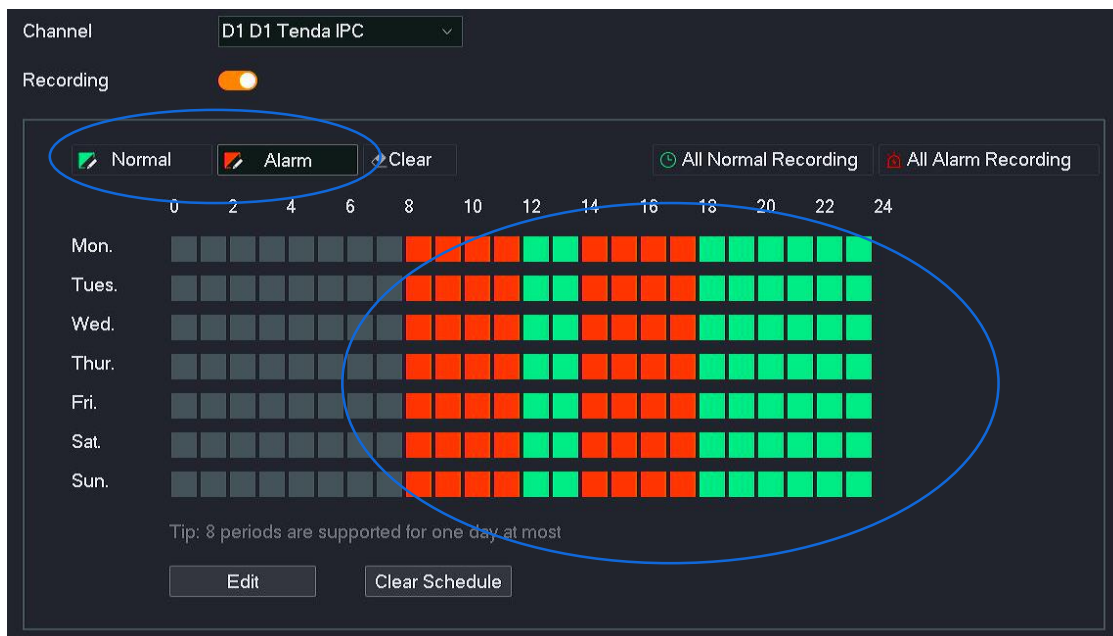

**Step 4** Set the schedule of other channel cameras.

Click  Sync to at the bottom of the page, and select the channel to synchronize the image parameter configuration of the D1 camera, which is **D2 to D4** in this example.

**Step 5** Click  Save.

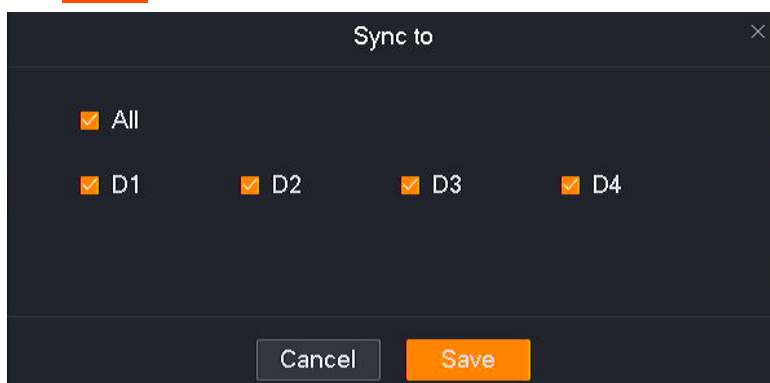

**---End**

After the setting completes, the system will enable the D1, D2, D3 and D4 cameras to record according to the above schedule.

## Method 2

**Step 1** [Log in to the GUI of the NVR.](#)

**Step 2** Navigate to **Configuration > Storage > Schedule.**

**Step 3** Set the schedule of the camera D1.

1. Set **Channel**, which is **D1** in this example, and ensure that the **Recording** function is enabled.
2. Click **Edit**.

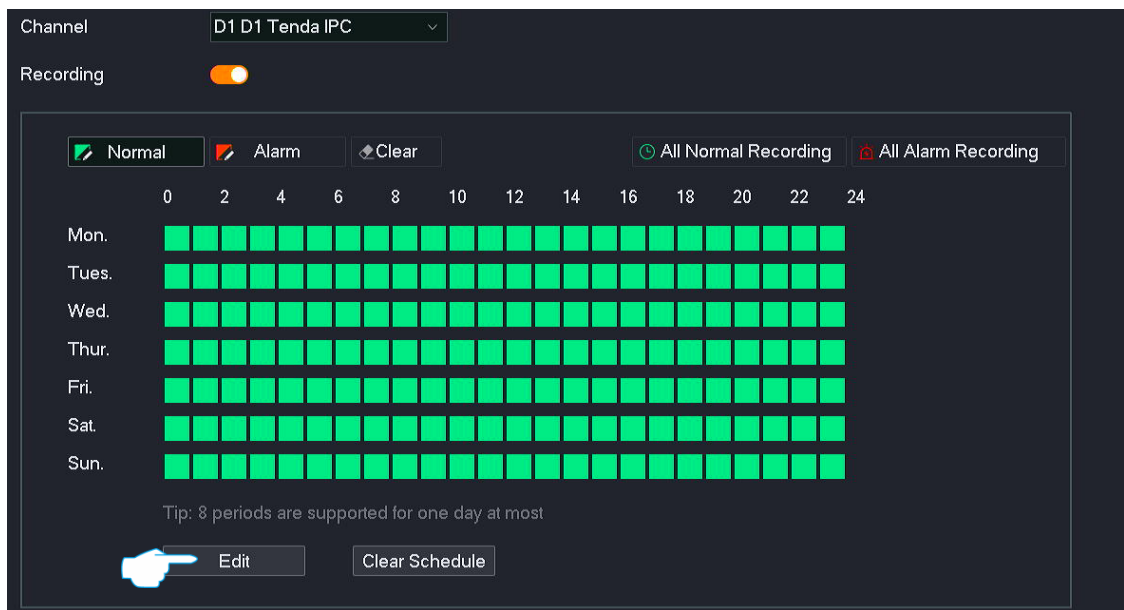



3. Set the schedule for **Monday** according to the schedule, as shown in the following figure. Then click **Copy to**.

| Mon.          | Tues. | Wed. | Thur. | Fri. | Sat. | Sun. |
|---------------|-------|------|-------|------|------|------|
| 08:00 - 12:00 |       |      |       |      |      |      |
| 12:00 - 14:00 |       |      |       |      |      |      |
| 14:00 - 18:00 |       |      |       |      |      |      |
| 18:00 - 24:00 |       |      |       |      |      |      |
| 00:00 - 00:00 |       |      |       |      |      |      |
| 00:00 - 00:00 |       |      |       |      |      |      |
| 00:00 - 00:00 |       |      |       |      |      |      |
| 00:00 - 00:00 |       |      |       |      |      |      |

Buttons: Cancel, Save, Copy to

4. Tick **All**, and click **Save**. Return to the **Edit Schedule** page, and click **Save**.

Copy to

All

Mon.    Tues.    Wed.    Thur.

Fri.    Sat.    Sun.

Buttons: Cancel, Save

**Step 4** Set the schedule of other channel cameras.

Click **Sync to** at the bottom of the page, and select the channel to synchronize the image parameter configuration of the D1 camera, which is **D2** to **D4** in this example.

**Step 5** Click **Save**.

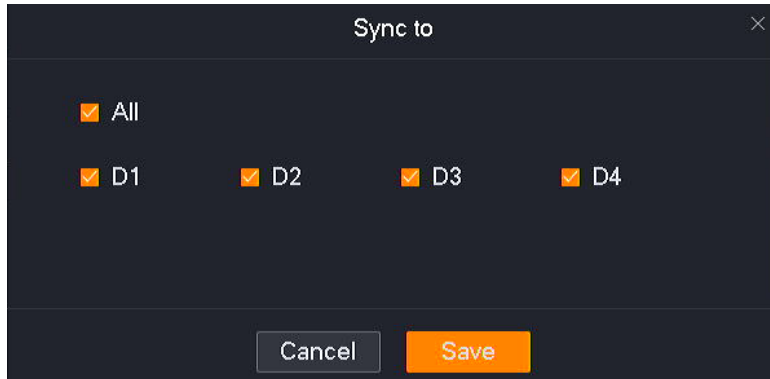

---End

After the setting completes, the system will enable the D1, D2, D3 and D4 cameras to record according to the above schedule.

## 4.6.4 Alarm Management

On the alarm management page, you can configure alarm events and the related information. If an alarm is triggered within the arming schedule, the system will alarm and record according to the linkage action you set.

### Motion Detection

#### Overview

Navigate to **Configuration > Alarm > Motion Detection**.



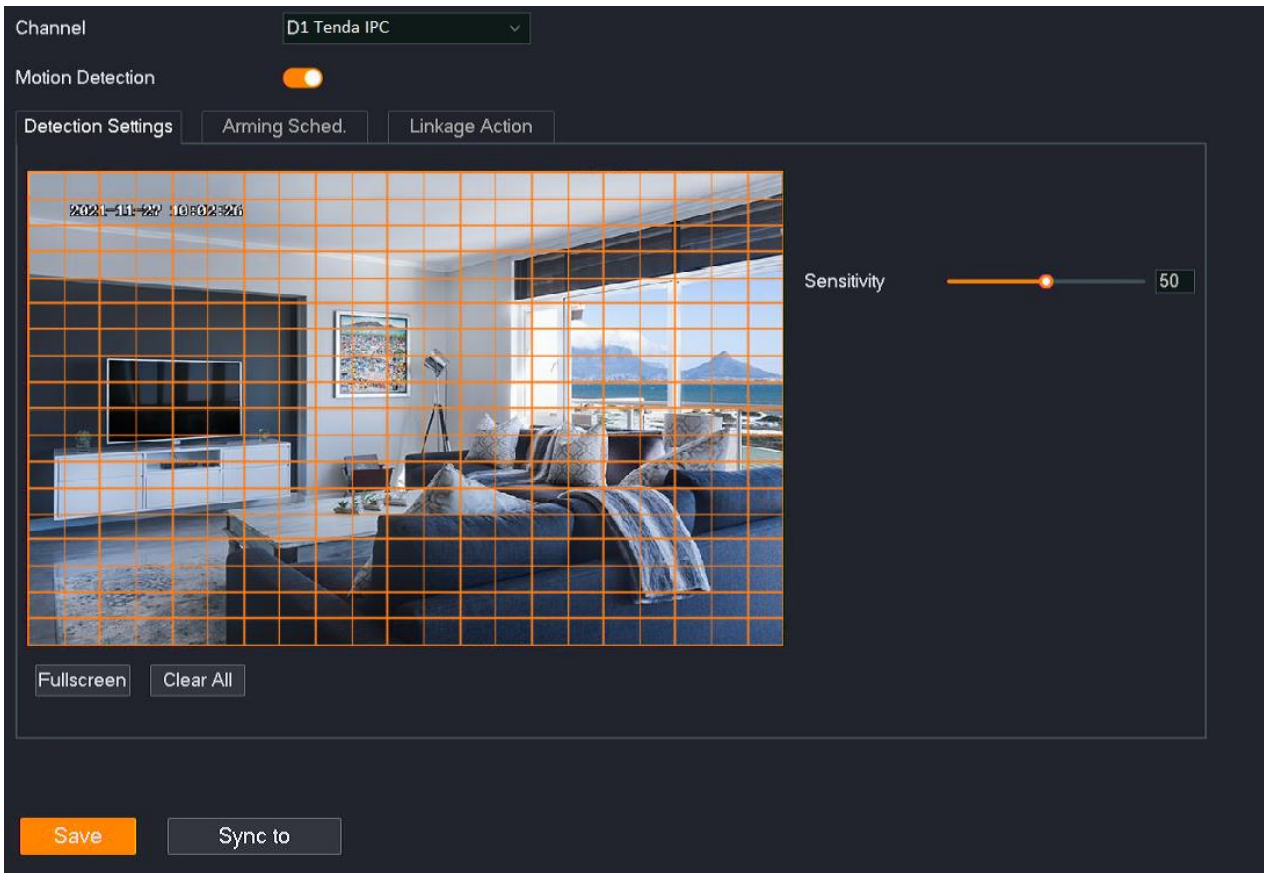

Motion detection refers to the detection and alarm of moving targets. When a moving target appears on the monitoring image and the moving range reaches the threshold corresponding to the preset sensitivity, the system will alarm and record according to the linkage action you set.

This function is disabled by default. When it is enabled, the page is shown as below.

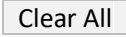

### Parameter & button description

| Parameter          | Description  |
|--------------------|--|
| Channel            | It specifies the channel chosen to set the schedule.   |
| Motion Detection   | It specifies whether the motion detection function is enabled.   |
| Detection Settings | Smart Detection<br>It specifies the detection type.<br>By default, the movement of all objects is detected. After <b>Human Detection</b> is enabled, the system will be alarmed only when a human is detected. |
|                    | Sensitivity<br>It specifies the detection sensitivity threshold that triggers an alarm. The larger the value, the easier it is to trigger an alarm.  |
|                    | Fullscreen<br>It is used to set all areas as the detection area with one click.  |
|                    | Clear All<br>It is used to clear the current detection area.   |
| Arming Sched.      | <input type="checkbox"/> Arming<br>It is used to set an arming schedule.<br>Click this button to draw the motion detection time in the timetable   |

| Parameter   | Description  |
|---|--|
|   | below.   |
|  | It is used to clear the time that has been set in the timetable below.<br>Click this button to clear the motion detection time in the timetable below.   |
|  | It is used to edit the motion detection schedule of a specific time.   |
|  | It is used to clear the current arming schedule.   |
| Common Linkage  | <p>It specifies the alarm method of the NVR after an alarm is triggered.</p> <ul style="list-style-type: none"> <li>– <b>Single Screen Display:</b> The alarm channel is displayed on a single screen on the <b>Live View</b> page after an alarm is triggered.</li> <li>– <b>Send Email:</b> The system will send an alarm email to the preset receiver email after an alarm is triggered. You need to set the relevant parameters of email for this alarm method to take effect. Please refer to <a href="#">Email Configuration</a> for details.</li> <li>– <b>Message Notification:</b> The system will send an alarm notification to TDSEE App after an alarm is triggered. The NVR needs to be added successfully through TDSEE App. Please refer to <a href="#">Manage the NVR through TDSEE App</a> for details.</li> <li>– <b>Audio Alarm (Camera):</b> The camera of the alarm channel will alarm through the audio after an alarm is triggered.</li> <li>– <b>Light Alarm (Camera):</b> The camera of the alarm channel will alarm through the supplement light after an alarm is triggered.</li> </ul> |
| Linkage Action  |  |
| Recording Linkage   | <p>It specifies the system enables the selected channel to record after an alarm is triggered.</p> <p> <b>NOTE</b></p> <p>Please ensure that a schedule has been set for the channel of the arming schedule.</p>  |
| Sync to.  | It is used to synchronize the current schedule to other channels.  |

## Configure Motion Detection Alarm

**Scenario:** Assume that you have set up a monitoring network with an NVR, installed four cameras and bound D1 to D4 respectively.

**Requirement:** The motion detection function is enabled for all cameras at 8:00 to 22:00 from Monday to Friday. When a human detection alarm is triggered, an alarm notification is pushed to the TDSEE app, an email is sent to the designated recipients, and trigger the corresponding

channel for recording.

**Solutions:** Configure the **Motion Detection** and **Email Configuration** functions to meet this requirement.

Assume that:

- SMTP server address: smtp.gmail.com
- SMTP service port: 465
- Sender email address: Tom@gmail.com
- Encryption mode: SSL
- Recipient email address: Jerry@gmail.com

**Procedure:**

**Step 1** [Log in to the GUI of the NVR.](#)

**Step 2** Set the motion detection.

1. Navigate to **Configuration > Alarm > Motion Detection**.
2. Set the motion detection function of the camera D1.
  - (1) Set **Channel**, which is **D1** in this example, and enable the **Motion Detection** function.
  - (2) Use the mouse to draw the detection area (by default, all monitoring area of the camera has been set as the detection area), and adjust the sensitivity as required.

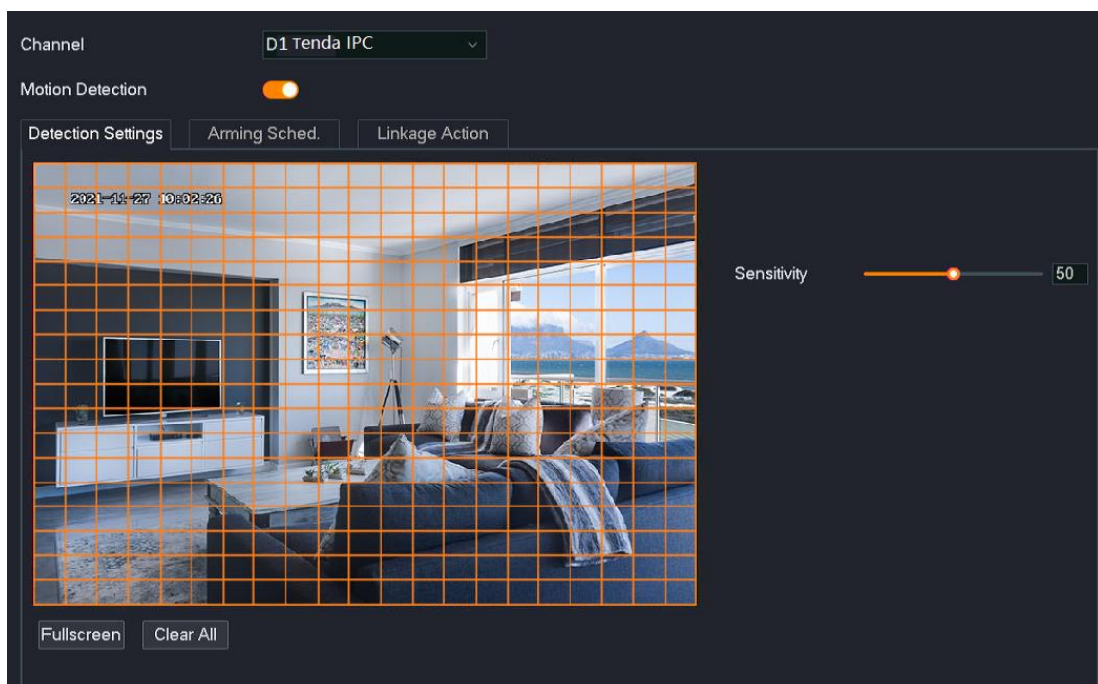

3. Set the motion detection of other channel cameras.

Click **Sync to** at the bottom of the page, and select the channels to synchronize the motion detection function of the D1 camera, which is **D2 to D4** in this example.

4. Click **Save**.

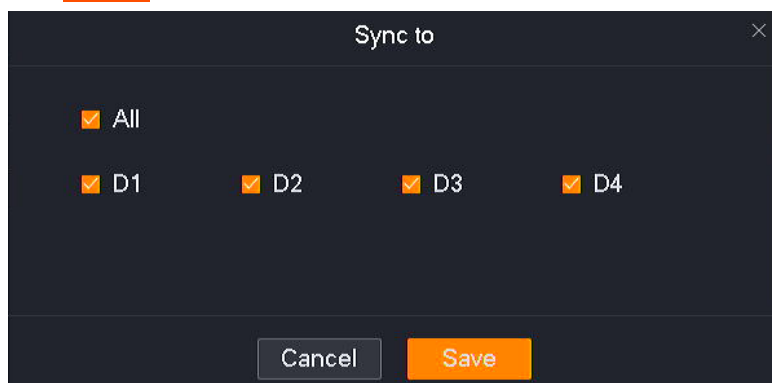

5. Set arming schedule.

- (1) Set arming schedule of the camera D1.

Click **Alarming Sched.**, and set the motion detection schedule, which is **8:00 to 20:00** from **Monday to Friday** in this example.



- (2) Set the alarming schedule of other channel cameras.

Click **Sync to** at the bottom of the page, and select the channels to synchronize the **Alarming Sched.** of the D1 camera, which are **D2** to **D4** in this example.

- (3) Click **Save**.

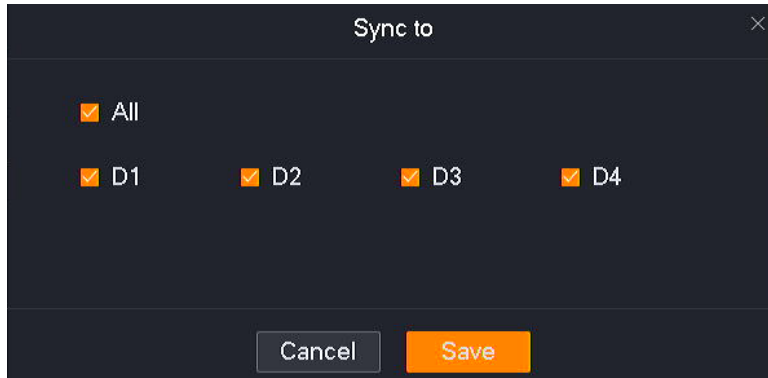

6. Set the linkage action.

- (1) Set the linkage action of the camera D1.

Click **Linkage Action**, and select alarm methods, which are **Send Email** and **Message Notification** in this example. Then select the recording channel, which is **D1** in this example.

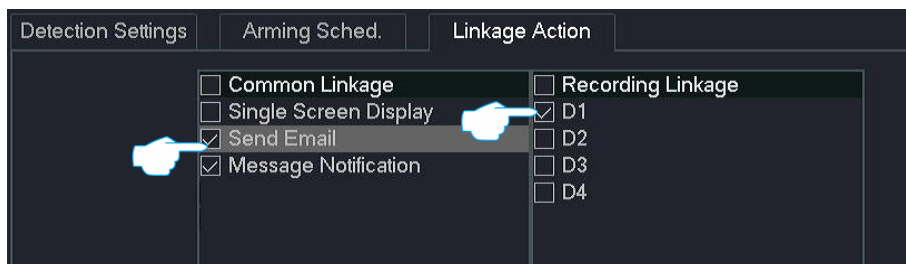

- (2) Set the linkage action of other channel cameras.

Click **Sync to** at the bottom of the page, and select the channels to synchronize the **Linkage Action** of the D1 camera, which is **D2** to **D4** in this example.

- (3) Click **Save**.

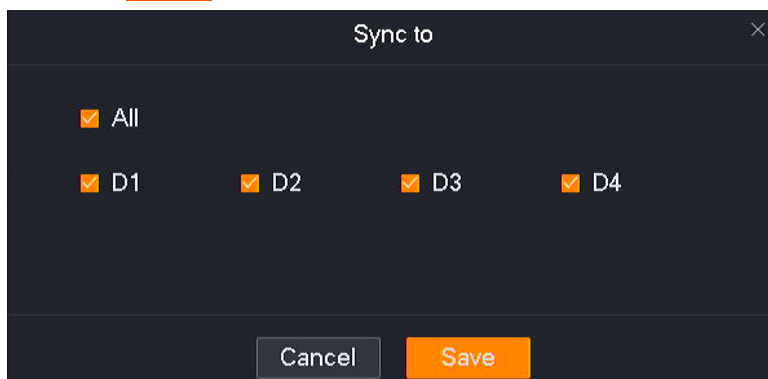

**Step 3** Set email alarm function. Refer to [Configure Email Alarm](#) for the related steps.

| No. | Recipient Name        | Recipient Email         | Test |
|-----|-----------------------|-------------------------|------|
| 1   | Jerry                 | Jerry@gmail.com         | Test |
| 2   | Custom recipient name | Recipient Email address | Test |
| 3   | Custom recipient name | Recipient Email address | Test |

**Step 4** Use TDSEE App to add the NVR. Refer to [Manage the NVR Through TDSEE App](#) for the related steps. (If set, please skip.)

**---End**

After the setting completes, if the system detects an alarm from D1 to D4, it will push an alarm notification and image to the TDSEE App, send emails to the designated recipients, and trigger the corresponding channel to record at the same time.



# Tampering Detection

## Overview



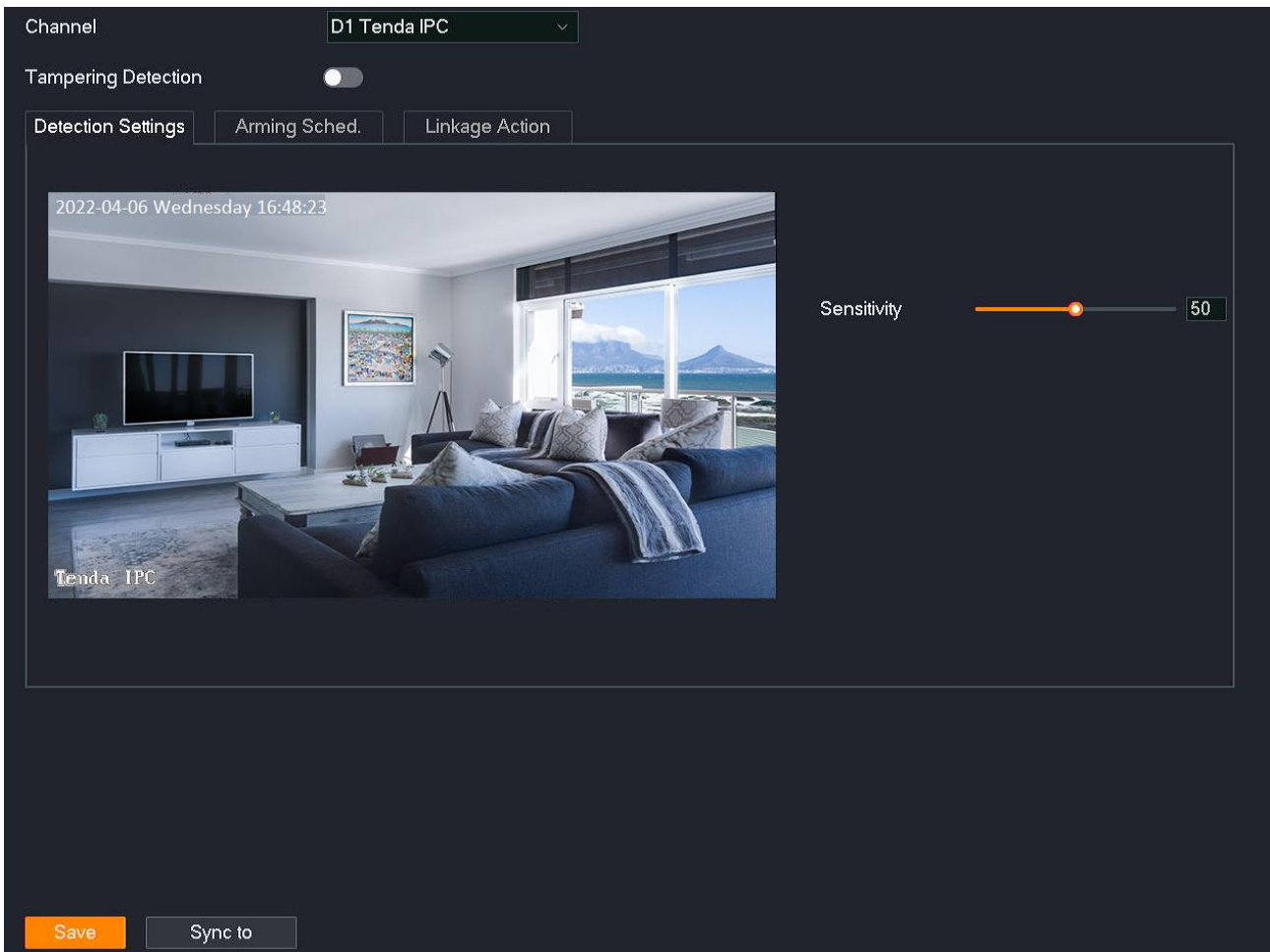

Navigate to **Configuration > Alarm > Tampering Detection**.

Tampering detection refers to the tampering detection alarm of the camera lens. When the camera lens is blocked by other objects and the moving sensitivity reaches the preset value, the system will alarm and record according to the linkage action you set.

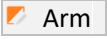
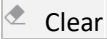

## Parameter & button description

| Parameter                         | Description  |
|-----------------------------------|--|
| Channel                           | It specifies the channel chosen to set the tampering detection alarm.  |
| Tempering Detection               | It specifies whether the tempering detection function is enabled.  |
| Detection Settings<br>Sensitivity | It specifies the detection sensitivity threshold that triggers an alarm. The larger the value, the easier it is to trigger an alarm. |

| Parameter      | Description  |
|----------------|--|
| Arming Sched.  |  Arm<br>It is used to set an arming schedule.<br>Click this button to draw the tempering detection time in the timetable below.   |
|                |  Clear<br>It is used to clear the time that has been set in the timetable below.<br>Click this button to clear the tempering detection time in the timetable below.   |
|                |  Edit<br>It is used to edit the tempering detection schedule of a specific time.  |
|                |  Clear<br>It is used to clear the current arming schedule.  |
| Linkage Action | Common Linkage<br>It specifies the alarm method of the NVR after an alarm is triggered. <ul style="list-style-type: none"> <li>– <b>Single Screen Display:</b> The alarm channel is displayed on a single screen on the <b>Live View</b> page after an alarm is triggered.</li> <li>– <b>Send Email:</b> The system will send an alarm email to the preset receiver email after an alarm is triggered. You need to set the relevant parameters of email for this alarm method to take effect. Please refer to <a href="#">Email Configuration</a> for details.</li> <li>– <b>Message Notification:</b> The system will send an alarm notification to TDSEE App after an alarm is triggered. The NVR needs to be added successfully through TDSEE App. Please refer to <a href="#">Manage the NVR through TDSEE App</a> for details.</li> </ul> |
|                | Recording Linkage<br><br>It specifies the system enables the selected channel to record after an alarm is triggered.<br>Please ensure that a schedule has been set for the channel of the arming schedule.  |
| Sync to.       | It is used to synchronize the current schedule to other channels.  |

## Configure Tempering Detection Alarm

**Scenario:** Assume that you have set up a monitoring network with an NVR, installed four cameras and bound D1 to D4 respectively.

**Requirement:** The tempering detection function is enabled for all cameras at 8:00 to 22:00 from Monday to Friday. When a tempering detection alarm is triggered, an alarm notification is pushed to the TDSEE app, an email is sent to the designated recipients, and trigger the corresponding channel for recording.

**Solutions:** Configure the **Tempering Detection** and **Email Configuration** functions to meet this requirement.

Assume that:

- SMTP server address: smtp.gmail.com
- SMTP service port: 465
- Sender email address: Tom@gmail.com
- Encryption mode: SSL
- Recipient email address: Jerry@gmail.com

**Procedure:**

**Step 1** [Log in to the GUI of the NVR.](#)

**Step 2** Set the tempering detection.

1. Navigate to **Configuration > Alarm > Tempering Detection.**

2. Set the tempering detection function.

(1) Set the tempering detection function of the camera D1.

Set **Channel**, which is **D1** in this example, enable the **Tempering Detection** function, and adjust the sensitivity as required.

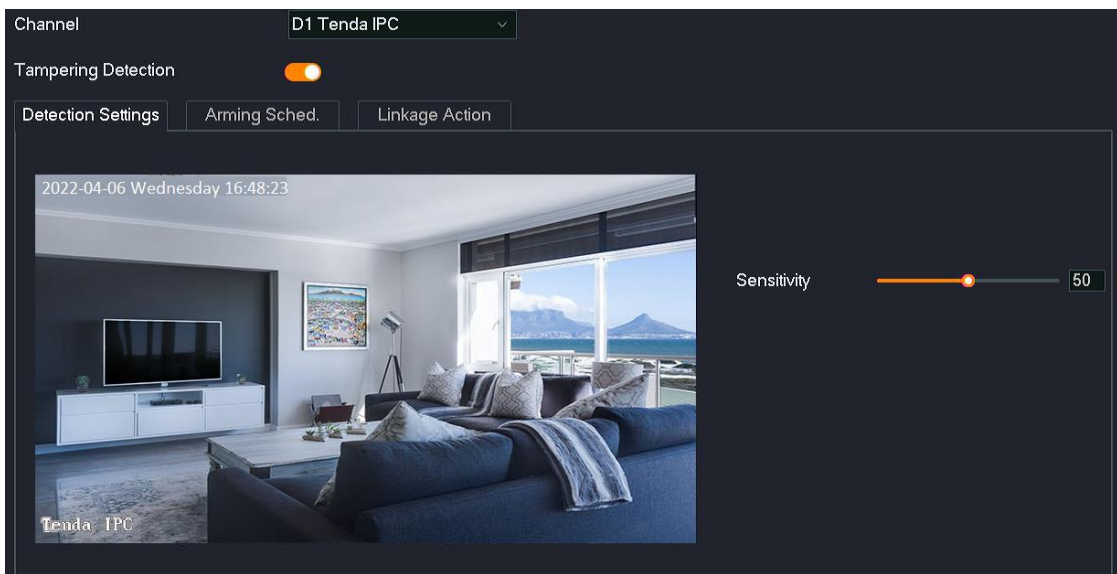

(2) Set the tempering detection function of other channel cameras.

Click **Sync to** at the bottom of the page, and select the channel to synchronize the tempering detection of the D1 camera, which is **D2** to **D4** in this example.

(3) Click **Save**.

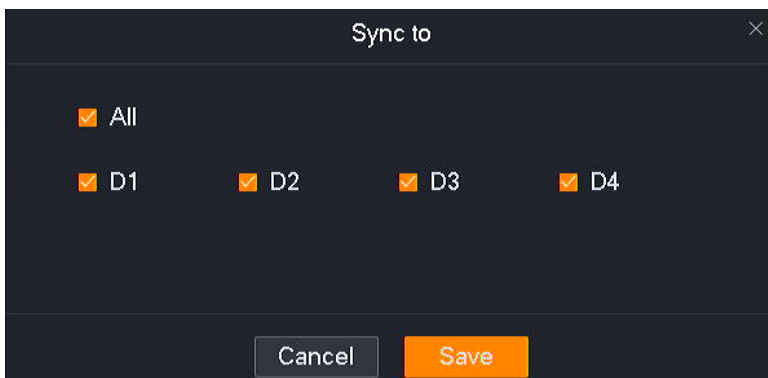

3. Set arming schedule.

(1) Set arming schedule of the camera D1.

Click **Alarming Sched.**, and set the motion detection schedule, which is **8:00 to 20:00** from **Monday to Friday** in this example.

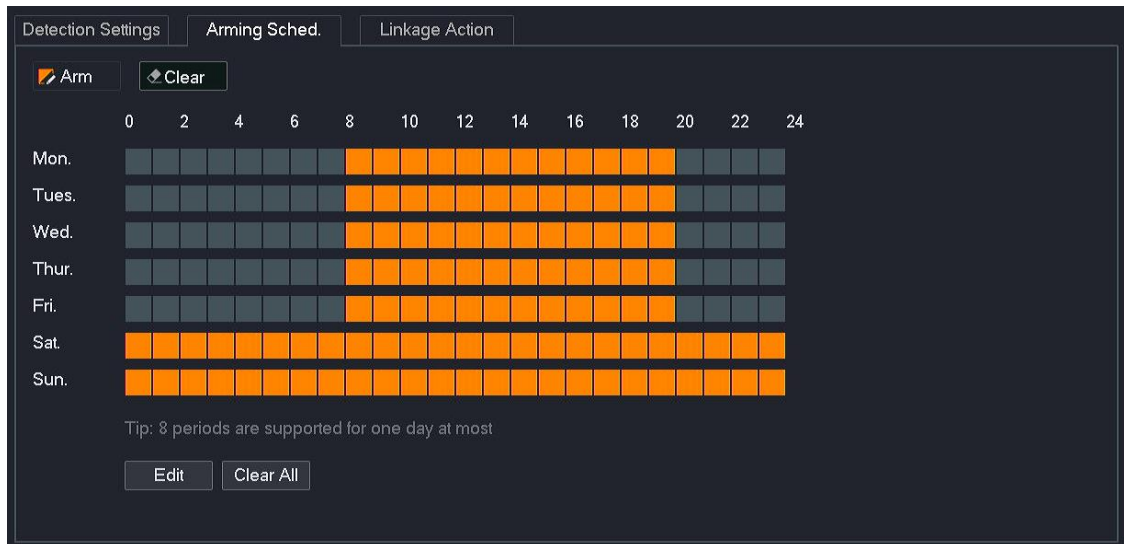

(2) Set the alarming schedule of other channel cameras.

Click **Sync to** at the bottom of the page, and select the channels to synchronize the **Alarming Sched.** of the D1 camera, which is **D2 to D4** in this example.

(3) Click **Save**.

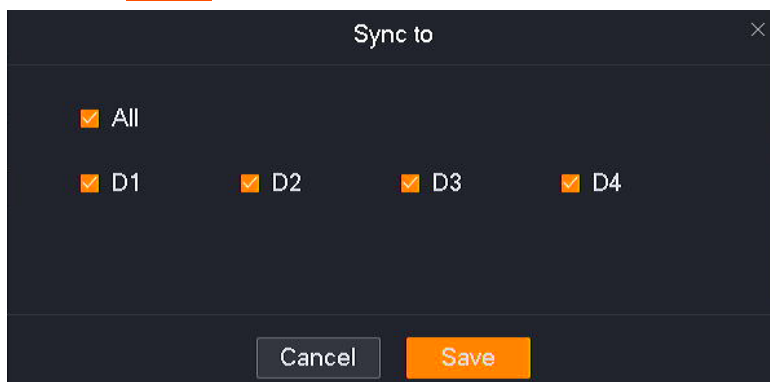

4. Set the linkage action.

(1) Set the linkage action of the camera D1.

Click **Linkage Action**, and select alarm methods, which are **Send Email** and **Message Notification** in this example. Then select the recording channel, which is **D1** in this example.

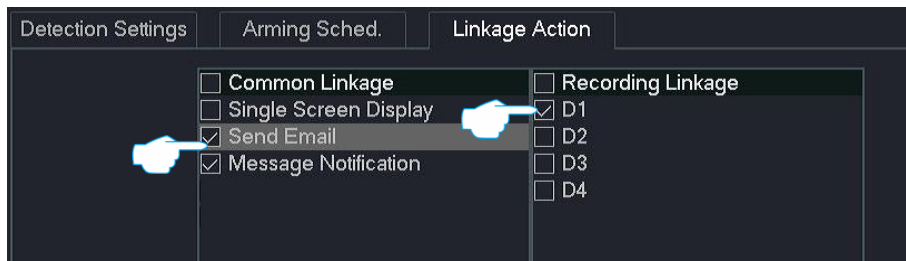

(2) Set the linkage action of other channel cameras.

Click **Sync to** at the bottom of the page, and select the channels to synchronize the **Linkage Action** of the D1 camera, which is **D2** to **D4** in this example.

(3) Click **Save**.

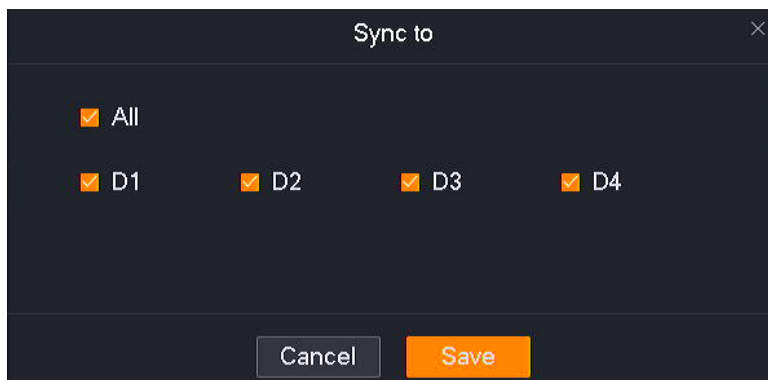

**Step 3** Set email alarm function. Refer to [Configure Email Alarm](#) for the related steps.

The screenshot displays the configuration interface for the Email Alarm Service. It includes the following settings:

- Email Alarm Service:
- SMTP Server: smtp.gmail.com
- SMTP Port: 465
- Anonymous:
- Sender: Tom
- Sender Email: Tom@gmail.com
- Password: [Masked]
- Encryption Mode: SSL
- Image Attachment:

The Recipient configuration is shown in a table:

| No. | Recipient Name        | Recipient Email         | Test                                |
|-----|-----------------------|-------------------------|-------------------------------------|
| 1   | Jerry                 | Jerry@gmail.com         | <input type="button" value="Test"/> |
| 2   | Custom recipient name | Recipient Email address | <input type="button" value="Test"/> |
| 3   | Custom recipient name | Recipient Email address | <input type="button" value="Test"/> |

**Step 4** Use TDSEE App to add the NVR. Refer to [Manage the NVR Through TDSEE App](#) for the related steps. (If set, please skip.)

**---End**

After the setting completes, if the system detects an alarm from D1 to D4, it will push an alarm notification and image to the TDSEE App, send emails to the designated recipients, and trigger the corresponding channel to record at the same time.

## Exception Detection

### Overview

Navigate to **Configuration > Alarm > Exception Detection**.

Exception detection refers to the detection and alarm of exception events. When an exception event occurs, the system will be alarmed according to the linkage action you set.

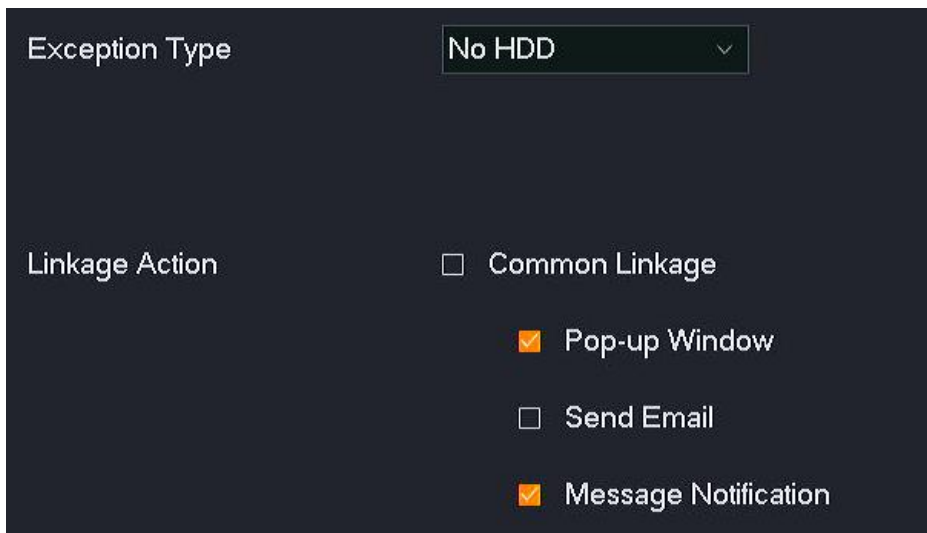

Exception Type: No HDD

Linkage Action:

- Common Linkage
- Pop-up Window
- Send Email
- Message Notification

### Parameter description

| Parameter      | Description   |
|----------------|---|
| Exception Type | <p>It specifies the exception type of alarm detection that is supported by the NVR.</p> <ul style="list-style-type: none"><li>– <b>No HDD:</b> When the HDD is not detected, the system will alarm according to the corresponding linkage action.</li><li>– <b>HDD error:</b> When an error of HDD (such as a read-write error) is detected, the system will alarm according to the corresponding linkage action.</li><li>– <b>HDD space is not enough:</b> When the HDD space is less than 20%, the system will alarm according to the corresponding linkage action.</li><li>– <b>Channel error:</b> When a channel error is detected, the system will alarm according to the corresponding linkage action.</li><li>– <b>Disconnected from the internet:</b> When the Ethernet cable is not connected to the LAN port or not plugged in tight, the system will alarm according to the corresponding linkage action.</li><li>– <b>IP address conflict:</b> When an IP address conflict is detected in the LAN, the system will alarm according to the corresponding linkage action.</li><li>– <b>Unauthorized access:</b> When the number of failed password entry attempts has reached the upper limit, the system will alarm according to the corresponding linkage action.</li></ul> |



| Parameter      | Description  |
|----------------|--|
| Channel        | <p>It is available only when <b>Exception Type</b> is set to <b>Channel error</b>.</p> <p>It specifies the channel chosen to set the <b>Channel error</b> alarm.</p>   |
| Linkage Action | <p>It specifies the alarm mode of the NVR after an alarm is triggered. The alarm mode of each <b>Exception Type</b> is set independently, and the supported alarm modes are different. The actual page prevails.</p> <ul style="list-style-type: none"> <li>– <b>Pop-up Window:</b> After an alarm is triggered, an alarm notification will be displayed in a pop-up window on the <b>Live View</b> page.</li> <li>– <b>Send Email:</b> After an alarm is triggered, the system will send an alarm email to the preset Recipient email. You need to set the relevant parameters of email for this alarm method to take effect. Please refer to <a href="#">Email Configuration</a> for details.</li> <li>– <b>Message Notification:</b> After an alarm is triggered, the system will send an alarm notification to TDSEE App. The NVR needs to be added successfully through TDSEE App. Please refer to <a href="#">Manage the NVR through TDSEE App</a> for details.</li> </ul> |

## Configure Exception Detection Alarm

**Scenario:** Assume that you have set up a monitoring network with the NVR, and the camera D1 is installed at the door.

**Requirement:** When the system detects the channel is abnormal and the LAN port connection is abnormal of the NVR, it will alarm through a pop-up window. When the system detects unauthorized access, it will push an alarm notification to TDSEE App.

**Solutions:** The **Exception Detection** function can meet this requirement.

### Procedure:

**Step 1** [Log in to the GUI of the NVR.](#)

**Step 2** Navigate to **Configuration > Alarm > Exception Detection**.

**Step 3** Set alarm mode of the channel error.

1. Set **Exception Type**, which is **Channel error** in this example.
2. Select the channel for exception detection, which is **D1** in this example.
3. Select alarm mode, which is **Pop-up Window** in this example.

Exception Type: Channel error

Channel:  All  D1  D2  D3  D4

Linkage Action:  Common Linkage  Pop-up Window  Send Email  Message Notification

**Step 4** Set alarm mode of LAN port connection error of the NVR.

1. Set **Exception Type**, which is **Disconnected from the internet** in this example.
2. Select alarm mode, which is **Pop-up Window** in this example.

Exception Type: Disconnected from the internet

Linkage Action:  Common Linkage  Pop-up Window

**Step 5** Set alarm mode of unauthorized access.

1. Set **Exception Type**, which is **Unauthorized access** in this example.
2. Select alarm mode, which is **Message Notification** in this example.

Exception Type: Unauthorized access

Linkage Action:  Common Linkage  Pop-up Window  Send Email  Message Notification

**Step 6** Click **Save** at the bottom of the page.

**Step 7** Manage the NVR through TDSEE App. Please refer to [Manage the NVR through TDESS App](#) for details.

---End

After the setting completes, when the system detects that D1 is abnormal and the LAN port connection of the NVR is abnormal, it will alarm through a pop-up window. When the system detects unauthorized access, it will push an alarm notification to TDSEE App.

## 4.6.5 Network Configuration

On the network configuration page, you can configure the NVR to access the internet, enable cloud service, modify the Wi-Fi network, check the connected Wi-Fi cameras and enable an email alarm.

### Internet Settings



Navigate to **Configuration > Network > Internet**.

You can view the LAN port parameters of the NVR, and can also modify the LAN port parameters to enable the NVR to access the internet.

|                 |                                     |
|-----------------|-------------------------------------|
| DHCP            | <input checked="" type="checkbox"/> |
| IP Address      | 192 . 168 . 0 . 166                 |
| Subnet Mask     | 255 . 255 . 255 . 0                 |
| Default Gateway | 192 . 168 . 0 . 1                   |
| Auto Obtain DNS | <input checked="" type="checkbox"/> |
| Primary DNS     | 1 . 0 . 0 . 0                       |
| Secondary DNS   | 8 . 8 . 8 . 8                       |
| MTU             | 1500                                |
| MAC Address     | c8:3a:35:00:89:ae                   |

#### Parameter description

| Parameter | Description  |
|-----------|--|
| DHCP      | It specifies whether to enable the function of the NVR automatically obtain an IP address from an upstream device. |

| Parameter       | Description   |
|-----------------|---|
|                 | <p>After the DHCP is enabled, the NVR can automatically obtain its IP address, subnet mask, default gateway and DNS server from the DHCP server in the network.</p> <p> <b>TIP</b></p> <p>If the <b>DHCP</b> is disabled, you need to manually configure an IP address, subnet mask, default gateway and DNS server for NVR.</p>   |
| IP Address      | <p>It specifies the IP address of the NVR.</p> <p>To connect the NVR to the internet, the IP address of the NVR must be set in the same network segment of the LAN IP address of the router with internet connectivity.</p>   |
| Subnet Mask     | It specifies the subnet mask of the NVR.  |
| Default Gateway | <p>It specifies the default gateway of the NVR.</p> <p>To connect the NVR to the internet, the IP address of the NVR must be set in the default gateway of the LAN IP address of the router with internet connectivity.</p>   |
| Auto Obtain DNS | <p>It specifies whether to enable the function of the NVR automatically obtaining DNS from an upstream device.</p> <p>After the <b>Auto Obtain DNS</b> function is enabled, the NVR can automatically obtain its DNS from the DHCP server in the network.</p> <p> <b>TIP</b></p> <p>If the <b>Auto Obtain DNS</b> is disabled, you need to manually configure primary DNS and secondary DNS for NVR.</p> |
| Primary DNS     | They specify the primary or secondary DNS server address of the NVR.  |
| Secondary DNS   | If the router with internet connectivity has a DNS proxy function, the Primary DNS address can be set to the IP address of the LAN port of the router with internet connectivity.   |
| MTU             | It specifies the largest data packet transmitted by the NVR, that is, the maximum transmission unit.  |
| MAC Address     | It specifies the LAN MAC address of the NVR.  |

## Cloud Service

### Overview

Navigate to **Configuration > Network > Cloud Service**.

The cloud service function enables the NVR to connect to the cloud, and you can add the NVR through TDSEE App to preview monitoring videos remotely, play back history recordings and view alarm notifications.

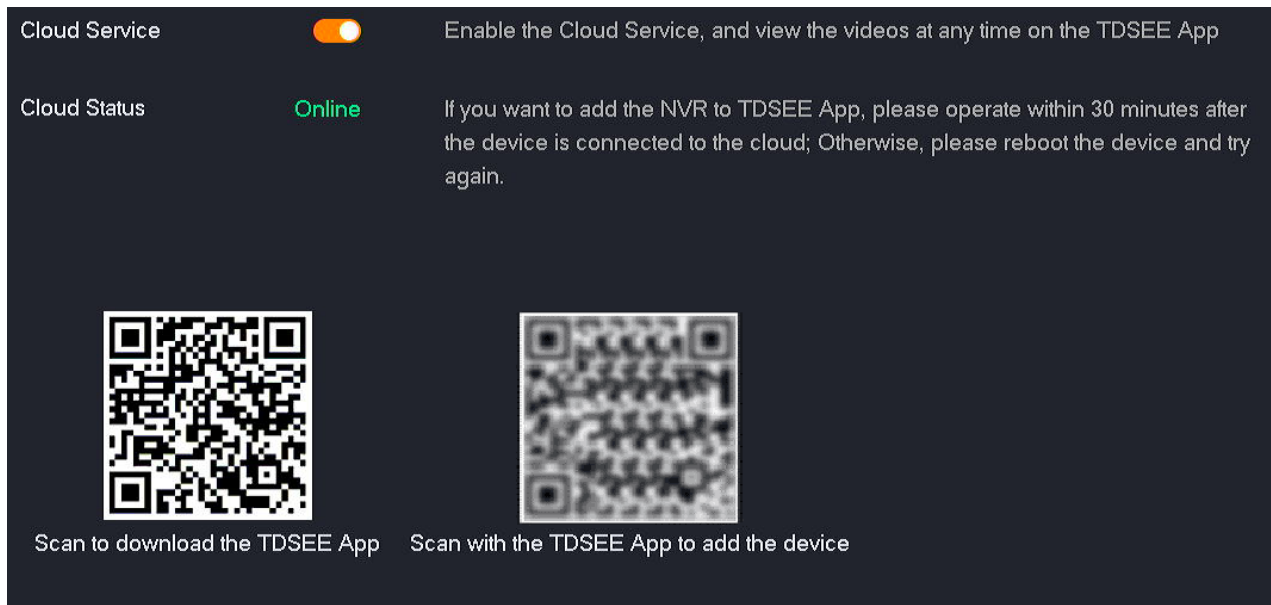



Cloud Service  Enable the Cloud Service, and view the videos at any time on the TDSEE App

Cloud Status **Online** If you want to add the NVR to TDSEE App, please operate within 30 minutes after the device is connected to the cloud; Otherwise, please reboot the device and try again.

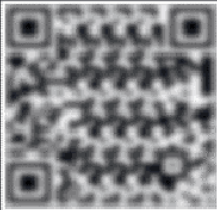
 Scan to download the TDSEE App

 Scan with the TDSEE App to add the device

### Parameter description

| Parameter     | Description   |
|---------------|---|
| Cloud Service | <p>It specifies whether to enable the cloud service function.</p> <p> <b>TIP</b></p> <p>Disabling the cloud service requires rebooting the NVR to enable the settings.</p>                                 |
| Cloud Status  | <p>It specifies the status of the NVR connected to the cloud.</p> <p>If the cloud status displays <b>Offline</b>, move the mouse to  on the top of the page, then follow the on-screen instructions.</p> |

## Manage the NVR Through TDSEE App

Assume that you have set up a monitoring network with the NVR, now you want to remotely manage the NVR and monitor the network through TDSEE App.

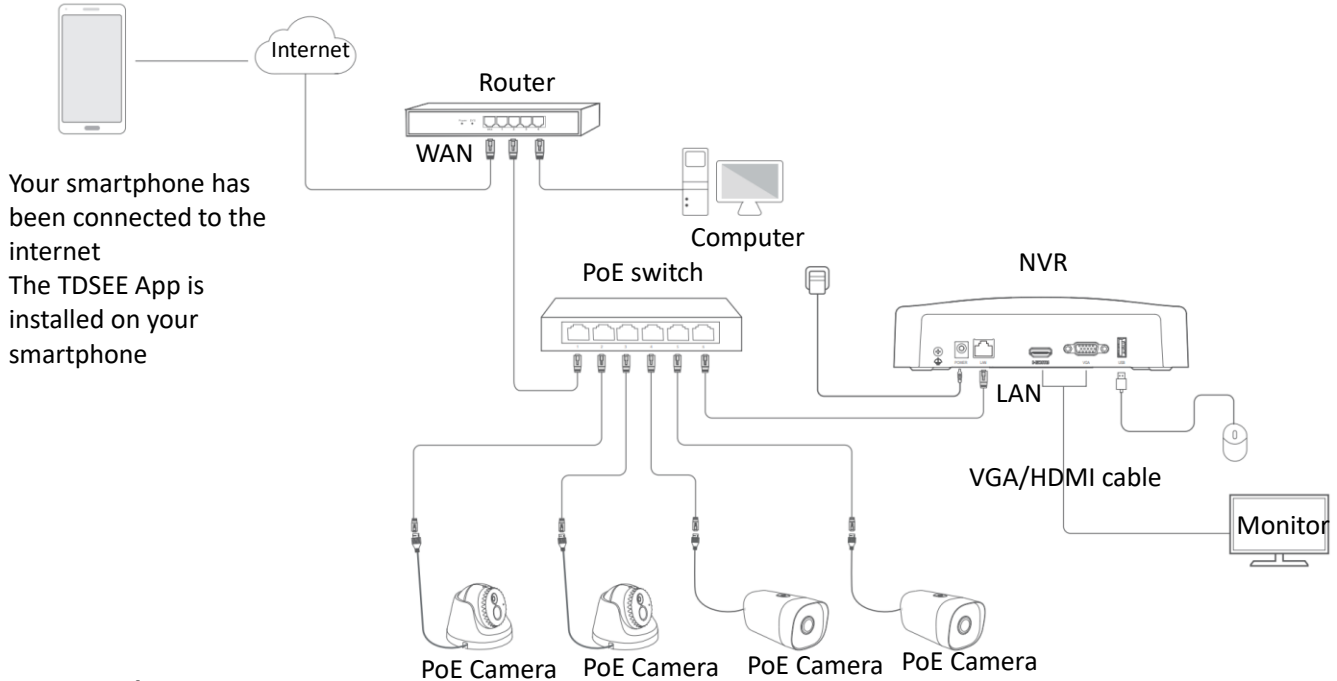

### Procedure:

**Step 1** Configure the NVR.

1. [Log in to the GUI of the NVR.](#)
2. Configure the cloud service function of the NVR.

Navigate to **Configure > Network > Cloud Service**, enable the **Cloud Service** function, and ensure that the **Cloud Status** is **Online**.

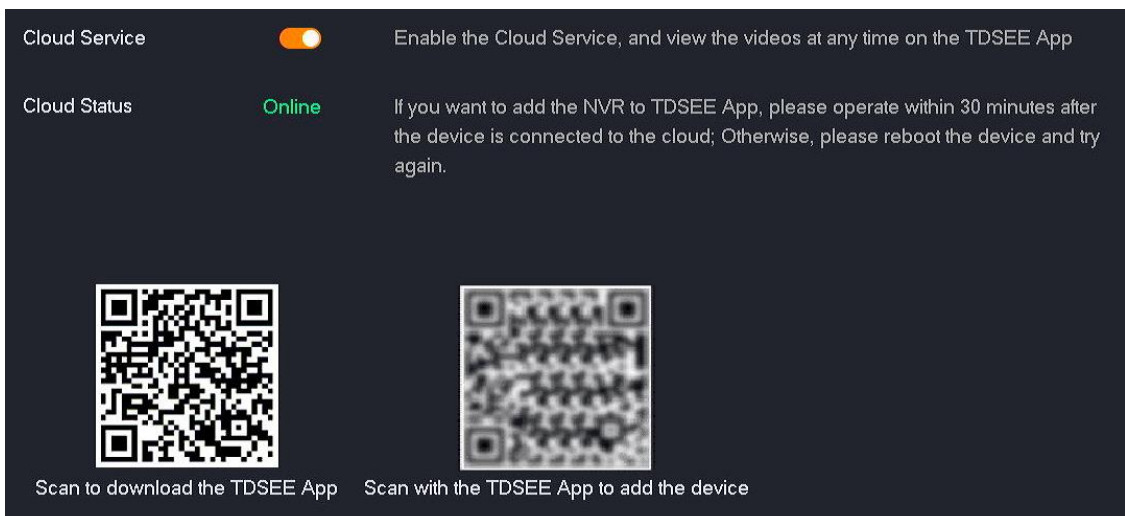

If the cloud status is **Offline**, please try the following solutions:

- Ensure that the router is connected to the internet in the network and the DHCP function is disabled.
- Ensure that the LAN port of the NVR is connected to the peer side (router or switch) correctly and securely.
- Ensure that the LAN [DHCP](#) function of the NVR is enabled.

**Step 2** Download and register the TDSEE App. (If you have registered, skip this step.)

1. After the smartphone is connected to the internet successfully, download and install the TDSEE App onto your smartphone by scanning the QR code below or by searching for TDSEE in the Google Play or App Store.



Scan the code to download TDSEE App

2. Run the TDSEE App.



TDSEE

3. Tap **Register**, and follow the instructions to complete user registration. You can authorize the TDSEE App to use a third-party account to log in.



To ensure that the login password of the NVR can be reset through TDSEE App, please register with the email address you used to activate the NVR.

---

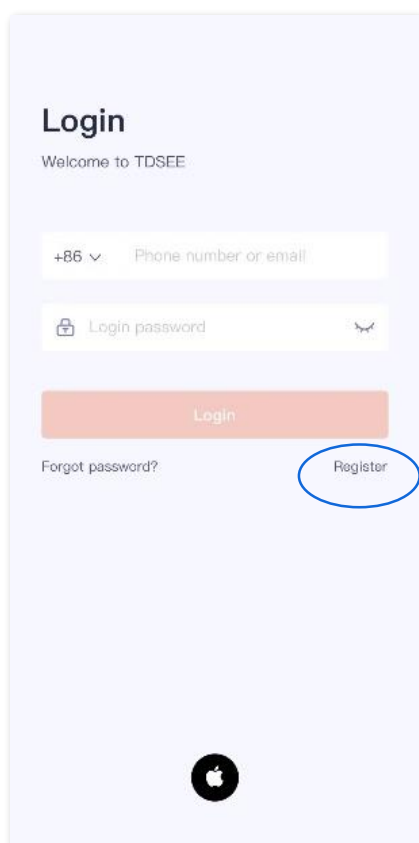

- Step 3** Add the NVR on TDSEE App.



Ensure that the NVR is powered on and working properly.

---



1. Enter the **Home** page, and tap **Add a device** or  in the upper-right corner.

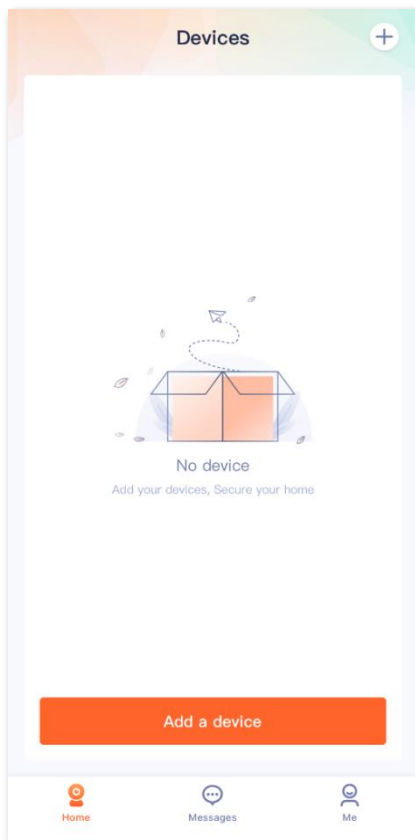

2. Scan the related QR code on the label at the bottom of the NVR or scan the QR code on the **Cloud Service** page, then follow the instructions in the App.

---End

After the setting completes, you can remotely preview real-time videos, play back the recordings and check alarm notifications through TDSEE App.

## Wi-Fi Configuration

The N3W-4H is taken as an example here.

### Wi-Fi Network

Navigate to **Configuration > Network > Wi-Fi > Wi-Fi Network**.

You can modify the Wi-Fi parameters of the NVR, such as Wi-Fi name, Wi-Fi password and channel.

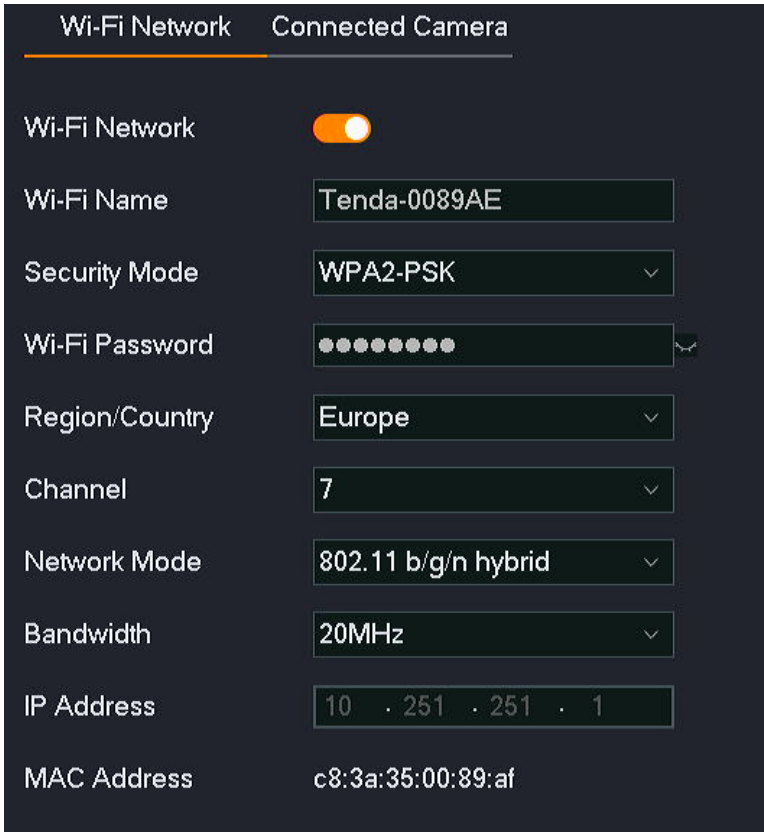

| Wi-Fi Network  | Connected Camera                    |
|----------------|-------------------------------------|
| Wi-Fi Network  | <input checked="" type="checkbox"/> |
| Wi-Fi Name     | Tenda-0089AE                        |
| Security Mode  | WPA2-PSK                            |
| Wi-Fi Password | ●●●●●●●●                            |
| Region/Country | Europe                              |
| Channel        | 7                                   |
| Network Mode   | 802.11 b/g/n hybrid                 |
| Bandwidth      | 20MHz                               |
| IP Address     | 10 . 251 . 251 . 1                  |
| MAC Address    | c8:3a:35:00:89:af                   |

### Parameter description

| Parameter      | Description   |
|----------------|---|
| Wi-Fi Network  | It specifies whether to enable the Wi-Fi network of the NVR.<br> <b>NOTE</b><br>Disabling the Wi-Fi network will affect the connection of the Wi-Fi camera. Please operate with caution. |
| Wi-Fi Name     | It specifies the Wi-Fi name of the NVR.   |
| Security Mode  | It specifies the encryption mode of the NVR.  |
| Wi-Fi Password | It specifies the Wi-Fi password of the NVR.   |

| Parameter      | Description   |
|----------------|---|
| Region/Country | It specifies the country or region where the NVR is located.  |
| Channel        | It specifies the operating channel of the Wi-Fi network.<br>The NVR is operating on a specific channel by default. You can modify the channel if the monitoring video is not smooth or the camera frequently goes online and offline. |
| Network Mode   | It specifies the wireless transmission protocol.  |
| Bandwidth      | It specifies the bandwidth of the wireless channel.   |
| IP Address     | It specifies the IP address of the wireless interface and it cannot be changed.   |
| MAC Address    | It specifies the MAC address of the wireless interface.   |

## Connected Camera

Navigate to **Configuration > Network > Wi-Fi > Connected Camera**.

You can view the related information of the Wi-Fi camera currently connected to the NVR, including IP address, MAC address, wireless speed, and uptime.

| Wi-Fi Network |                | Connected Camera  |           |                    |
|---------------|----------------|-------------------|-----------|--------------------|
| No.           | IP Address     | MAC Address       | Rate      | Uptime             |
| 1             | 10.251.251.114 | c8:3a:35:c0:10:4f | 492(Kbps) | 5 hr 49 min 0 sec  |
| 2             | 10.251.251.153 | c8:3a:35:c0:10:66 | 815(Kbps) | 5 hr 48 min 32 sec |
| 3             | 10.251.251.162 | c8:3a:35:c0:10:73 | 704(Kbps) | 57 min 44 sec      |
| 4             | 10.251.251.164 | c8:3a:35:c0:10:81 | 771(Kbps) | 56 min 50 sec      |

## Parameter description

| Parameter   | Description                                 |
|-------------|---|
| No.         | It specifies the number of the camera.      |
| IP Address  | It specifies the IP address of the camera.  |
| MAC Address | It specifies the MAC address of the camera. |

| Parameter | Description  |
|-----------|--|
| Rate      | It specifies the real-time wireless rate of the camera.                                |
| Uptime    | It specifies the uptime of the camera that was last connected to the Wi-Fi of the NVR. |

## PoE Configuration

Navigate to **Configuration > Network > PoE**. The N6P-4H is taken as an example here.

You can view the connection status, power and IP address of the PoE port of the NVR, and can also switch the operating mode of the PoE port.



### Parameter & button description

| Parameter   | Description   |
|-------------|---|
| 1, 2, 3, 4  | It specifies the number of the PoE port of the NVR.   |
| nW          | It specifies the output power of the PoE port of the NVR.   |
| Port Status | It specifies the current operating mode of the PoE port of the NVR. Click it to switch the common mode to long-distance mode.<br><br>Under normal mode, the maximum transmission distance is 100 m. |

| Parameter       | Description   |   |
|-----------------|---|---|
| Long-range Mode | It specifies the current operating mode of the NVR PoE port. Click it to switch the long-range mode to common mode. Under long-distance mode, the port rate is reduced to 10 Mbps, and the maximum transmission distance is 250 m |   |
| Port Power      | Actual Power  | It specifies the output power of the current PoE power supply of the NVR. |
|                 | Remaining Power   | It specifies the remaining power of the PoE power supply of the NVR.      |
| IP Address      | It specifies the IP address of the PoE port of the NVR. The IP address cannot be modified.  |   |

## Port Configuration

Navigate to **Configuration > Network > Port**.

The port number indicates different network services, for example, port 443 indicates HTTPS service. You can view or modify each service port number here.

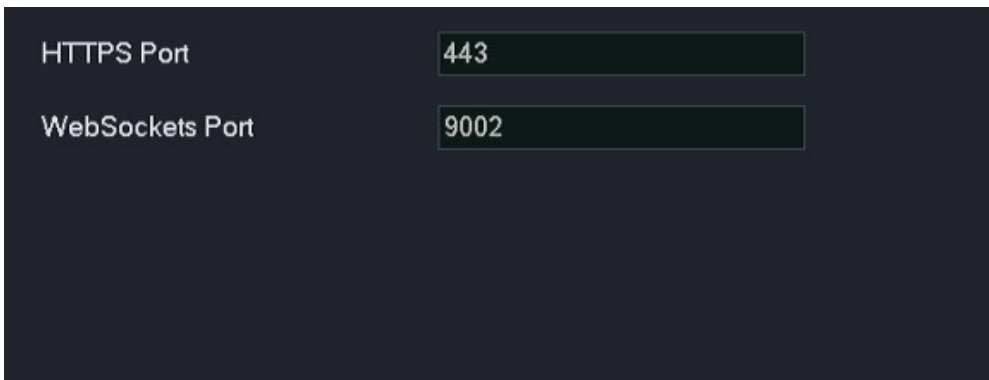

### Parameter description

| Parameter       | Description  |
|-----------------|--|
| HTTPS Port      | It specifies the port of the HTTPS protocol. You are recommended to keep the default settings.<br>After the HTTPS port number is modified, when you log in to the web UI of the camera, you can manually enter this port number behind the IP address of the camera. The access format is HTTPS://camera IP address: HTTPS port. |
| WebSockets Port | It specifies the port of the WebSockets protocol. You are recommended to keep the default settings.  |

| Parameter | Description   |
|-----------|---|
|           | You can realize two-way communication between the browser and the server, and allow the server to push data to the browser through the WebSockets protocol. |

## Email Configuration

### Overview

Navigate to **Configuration > Network > Email**.

The alarm linkage action of this NVR supports email alarm. If you want to receive an alarm notification through email, you need to configure the email alarm function first.

By default, this function is disabled. When it is enabled, the page is shown as below.

The screenshot shows the Email Configuration page with the following settings:



- Email Alarm Service:
- SMTP Server:
- SMTP Port:
- Anonymous:
- Sender:
- Sender Email:
- Password:
- Encryption Mode:
- Image Attachment:

The Recipient table is as follows:

| No. | Recipient Name                                     | Recipient Email                                      | Test                                |
|-----|--|--|-------------------------------------|
| 1   | <input type="text" value="Custom recipient name"/> | <input type="text" value="Recipient Email address"/> | <input type="button" value="Test"/> |
| 2   | <input type="text" value="Custom recipient name"/> | <input type="text" value="Recipient Email address"/> | <input type="button" value="Test"/> |
| 3   | <input type="text" value="Custom recipient name"/> | <input type="text" value="Recipient Email address"/> | <input type="button" value="Test"/> |

### Parameter description

| Parameter           | Description  |
|---------------------|--|
| Email Alarm Service | It specifies whether to enable the email alarm service function.                     |
| SMTP Server         | It specifies the SMTP server address and supports the IP address and domain address. |

| Parameter        | Description   |  |
|------------------|---|--|
| SMTP Port        | <p>It specifies the SMTP server port.</p> <p> <b>NOTE</b><br/>After the encryption is enabled (SSL or TLS), the SMTP server port will be changed, users need to check and fill it by themselves.</p>   |  |
| Anonymous        | <p>It specifies whether to enable the <b>Anonymous</b> function.</p> <p>When it is enabled, the configuration of the sender information is not required, including sender name and sender email information.</p> <p> <b>NOTE</b><br/>This function is only available when the SMTP server address supports sending anonymous emails.</p>   |  |
| Sender           | It specifies the sender's name. You can custom it as required.  |  |
| Sender Email     | It specifies the email account that sends the email.  |  |
| Password         | It specifies the password corresponding to the email account of the sender.   |  |
| Encryption Mode  | <p>It specifies the encryption mode for mail transmission.</p> <ul style="list-style-type: none"> <li>– <b>None:</b> No encrypted transmission.</li> <li>– <b>SSL:</b> Secure Sockets Layer is a security protocol. It uses data encryption, identity verification, and message integrity verification mechanisms to provide security guarantees for network data transmission.</li> <li>– <b>TLS:</b> Transport Layer Security is a security protocol that provides security and data integrity for network communications.</li> </ul> |  |
| Image Attachment | <p>It specifies whether to send alarm pictures.</p> <p>After this function is enabled, when the system detects an alarm, it will send an alarming video and the captured picture at the same time.</p>  |  |
| Recipient        | No.   | It specifies the number of the recipient.                              |
|                  | Recipient Name  | It specifies the name of the recipient. You can custom it as required. |
|                  | Recipient Email   | It specifies the email address of the recipient.                       |
|                  | Test  | It is used to test whether mail is sent and received normally.         |

## Configure Email Alarm

**Scenario:** Assume that you have set up the monitoring network with NVR, and D1 to D4 have been connected to the camera.

**Requirement:** If there is a channel error in D1 to D4, such as **Camera offline**, an alarm notification will be pushed through email.

**Solutions:** Configure the **Exception Detection and Email Configuration** functions to meet this requirement.

- SMTP server address: smtp.gmail.com
- SMTP service port: 465
- Sender email address: Tom@gmail.com
- Encryption mode: SSL
- Recipient email address: Jerry@gmail.com

### Procedure:



Please ensure that the NVR has connected to the internet successfully before configuring the email alarm.

**Step 1** Enable the SMTP service of the sender's email. **Gmail** is taken as an example here. (If it is enabled, skip this step.)

1. Open the browser, and log in to your Gmail. Click  (**Settings**) in the upper-right corner → **See all settings**.

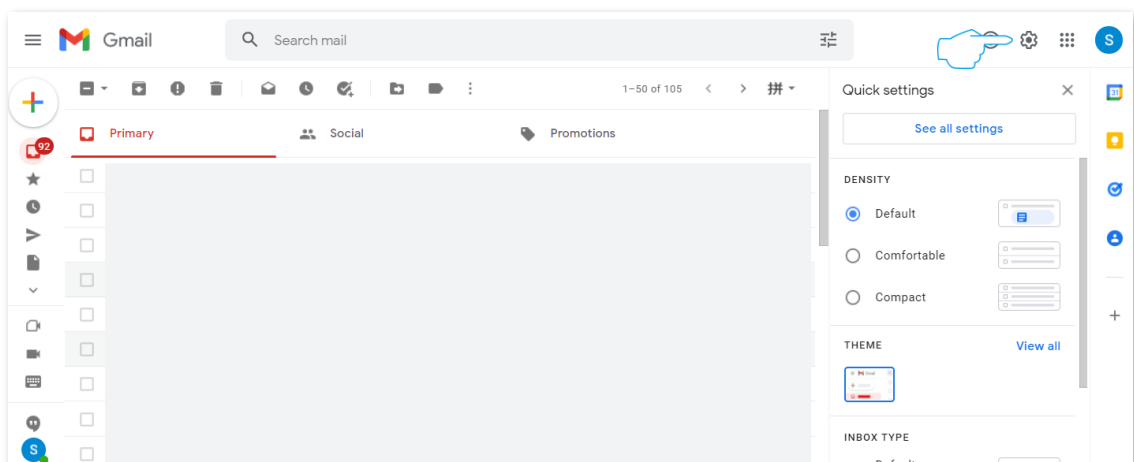



2. Click **Forwarding and POP/IMAP** on the settings page. Find **IMAP access**, tick **Enable IMAP**, and click **Save Changes** at the bottom of the page.

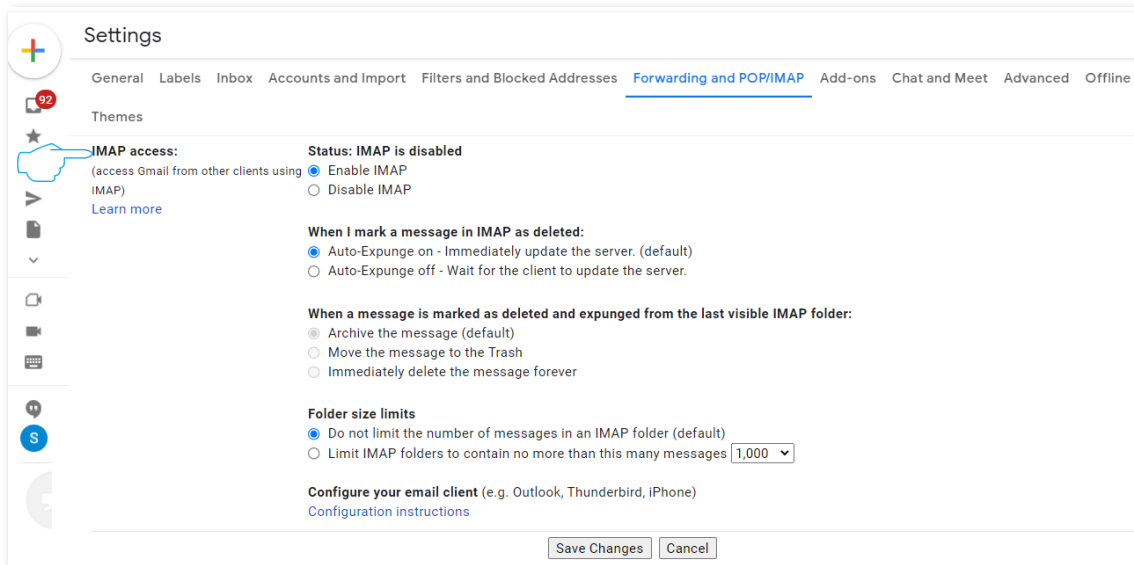

**Step 2** Configure the NVR.

1. [Log in to the GUI of the NVR.](#)
2. When the channel is abnormal, you can set the linkage action.
  - (1) Navigate to **Configuration > Alarm > Exception Detection.**
  - (2) Set **Exception Type**, which is **Channel error** in this example.
  - (3) Select the channels for exception detection, which are **D1 to D4** in this example.
  - (4) Set **Linkage Action**, which is **Send Email** in this example.
  - (5) Click **Save** at the bottom of the page.

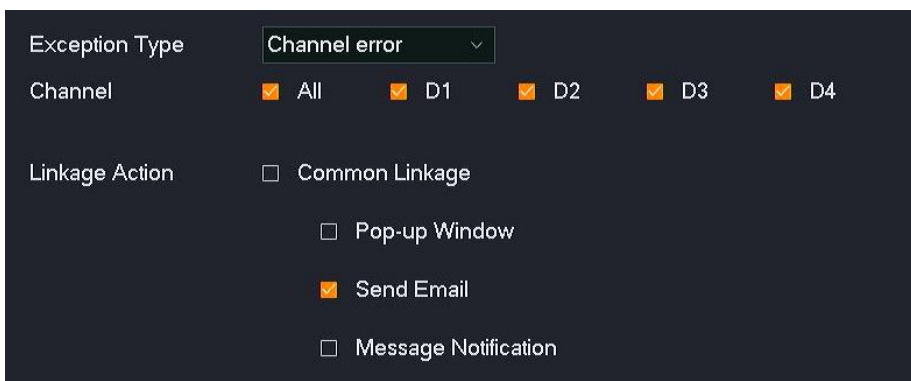

3. Configure the email alarm function.
  - (1) Navigate to **Configuration > Network > Email.**
  - (2) Enable the **Email Alarm Service** function.

- (3) Enter the SMTP server address, which is **smtp.gmail.com** in this example. Enter the SMTP server port, which is **465** in this example.
- (4) Set the name of the sender, which is **Tom** in this example. Enter the email address of the sender, which is **Tom@gmail.com** in this example.
- (5) Enter the login password of the Gmail of the sender. Click the icon  behind the input box to display the entered password.
- (6) Enable the **Image Attachment** function.
- (7) Set the name of the recipient, which is **Jerry** in this example. Enter the email address of the recipient, which is **Jerry@gmail.com** in this example.
- (8) Click **Test**.



If the test fails, try the following steps:

1. Please recheck the parameters you set in the NVR.
  2. Log in to your Gmail, click **Accounts and Import** on the settings page, find **Change account settings**, and click **Other Google Account** settings.
  3. Click **Security**, find less secure app access, and enable the **Turn on access** function.
- (9) Click **Save** at the bottom of the page.

| Email Alarm Service |                                     |                       |                         |      |
|---------------------|-------------------------------------|-----------------------|-------------------------|------|
| SMTP Server         | smtp.gmail.com                      |                       |                         |      |
| SMTP Port           | 465                                 |                       |                         |      |
| Anonymous           | <input type="checkbox"/>            |                       |                         |      |
| Sender              | Tom                                 |                       |                         |      |
| Sender Email        | Tom@gmail.com                       |                       |                         |      |
| Password            | ●●●●●●●●●●                          |                       |                         |      |
| Encryption Mode     | SSL                                 |                       |                         |      |
| Image Attachment    | <input checked="" type="checkbox"/> |                       |                         |      |
| Recipient           | No.                                 | Recipient Name        | Recipient Email         | Test |
|                     | 1                                   | Jerry                 | Jerry@gmail.com         | Test |
|                     | 2                                   | Custom recipient name | Recipient Email address | Test |
|                     | 3                                   | Custom recipient name | Recipient Email address | Test |

---End

After the setting completes, if there is a channel error in D1 to D4, an alarm notification will be pushed to the recipient through email.

## DDNS

### Overview

Navigate to **Configuration > Network > DDNS**.

Through the DDNS function, you can always map the dynamic IP address of the router (a public IP address) to a fixed domain name, so that internet users can access the router through this domain name.

DDNS

Connection Status Disconnected

Service Provider Oray DDNS

Server Address ddns.oray.com

Domain Name Get domain name at service.

User Name Registered user account at s

Password Registered user password at

### Parameter description

| Parameter         | Description   |
|-------------------|---|
| DDNS              | It specifies whether to enable the DDNS function.   |
| Connection Status | It specifies the connection status of the DDNS.   |
| ISP               | It specifies the ISP of the DDNS.   |
| Server Address    | It specifies the IP address of the DDNS.<br>The system has preset the DDNS server address of the corresponding ISP. |
| Domain Name       | It specifies the applied domain name on the website of the DDNS ISP.  |
| User Name         | It specifies the user name/password to log in to DDNS.  |
| Password          | The login user name and login password are registered on the website of the DDNS ISP.                               |

## Internet User Using the Domain Name to Access Web UI of the Camera

**Scenario:** Assume that you have set up a monitoring network with an NVR and connected to the internet.

**Requirement:** The user can access the web UI of the camera through the fixed domain name.

**Solution:** Configure the DDNS and UPnP functions to meet this requirement.

Assume that the related information of the registered DDNS service is as follows:

- ISP: Dyndns
- User name: Tom-Jerry
- Password: tomjerry123456
- Domain name: jointnet.dyndns.org

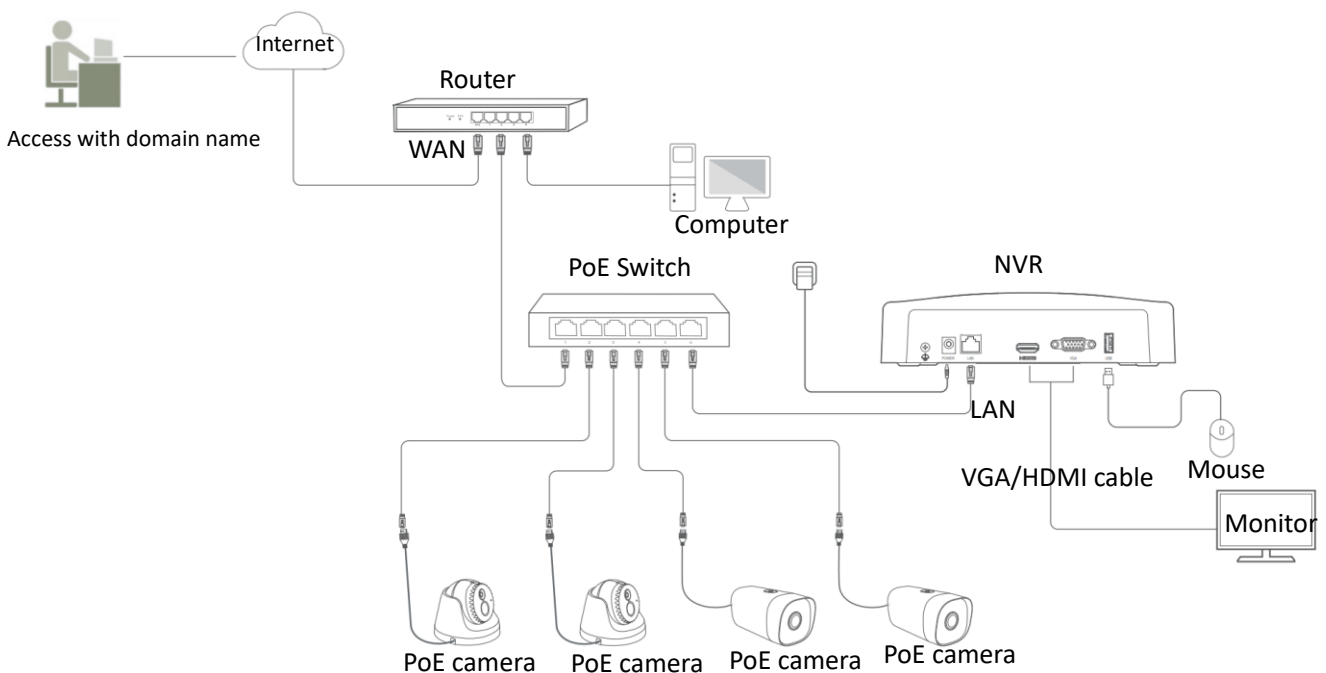

Please ensure that the WAN port of the router obtains a public IP address before configuration.

### Procedure:

**Step 1** [Log in to the GUI of the NVR.](#)

**Step 2** Configure the DDNS.

1. Navigate to **Configuration > Network > DDNS.**

2. Set the button to the enabled status .
3. Click the drop-down list to select **ISP**, which is **Dyndns DDNS** in this example.
4. Enter the applied domain name on the website of the **ISP**, which is **jointnet.dyndns.org** in this example.
5. Enter the login user name and login password registered on the website of the DDNS ISP, which are **Tom-Jerry** and **tomjerry123456** in this example.
6. Click **Save** at the bottom of the page.

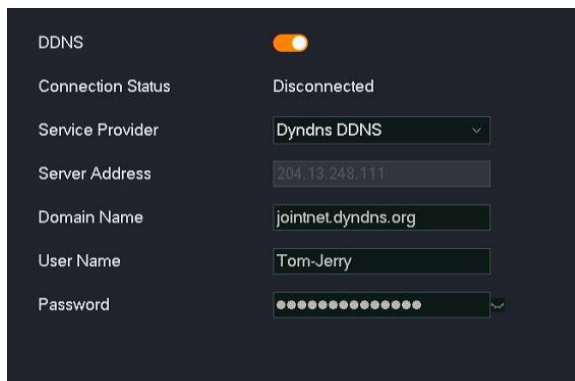

DDNS

Connection Status Disconnected

Service Provider Dyndns DDNS

Server Address 204.13.248.111

Domain Name jointnet.dyndns.org

User Name Tom-Jerry

Password ●●●●●●●●●●

Wait a moment, when the connection status is **Connected**, the DDNS is configured successfully.

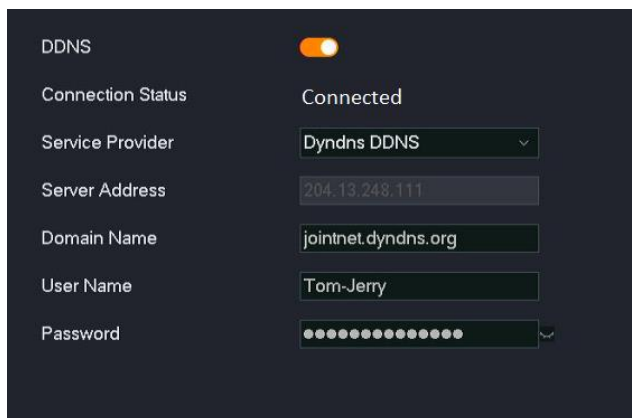

DDNS

Connection Status Connected

Service Provider Dyndns DDNS

Server Address 204.13.248.111

Domain Name jointnet.dyndns.org

User Name Tom-Jerry

Password ●●●●●●●●●●

**Step 3** To configure the UPnP, please refer to the [Internet User Using the IP Address to Access the Web UI of the NVR](#) for detailed steps.

**---End**

After the setting completes, the user can use the domain name to successfully access the web UI of the NVR. When configuring the UPnP, the external port of the HTTPS is not the default port number, the access format is https://domain name: external port.

The access address is https://jointnet.dyndns.org in this example.

## UPnP

### Overview

Navigate to **Configuration > Network > UPnP**.

The internet user cannot access the NVR by default. The UPnP function enables the internet user to access the NVR through an external IP address.

After the UPnP function is enabled, the NVR will open the internal network port and external network port of the designated service, and identify the corresponding service with the LAN IP address and the internal network port. If the NVR receives a request from the external network port of the internet, the NVR forwards the request to the corresponding internal network port, so that internet users can access the NVR through the external IP address.



The UPnP function of the NVR can be used with the UPnP function of the camera.

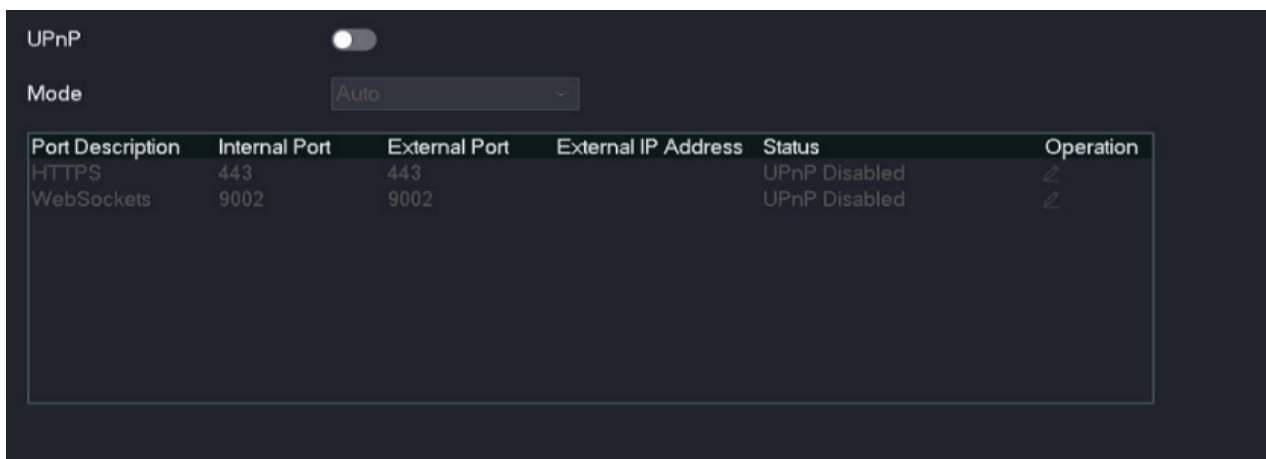

### Parameter description

| Parameter        | Description  |
|------------------|--|
| UPnP             | It specifies whether to enable the UPnP function.  |
| Mode             | It specifies the mode of port mapping. <ul style="list-style-type: none"><li>– <b>Auto:</b> The system uses the preset external network port to map to the internal network port.</li><li>– <b>Custom:</b> The system uses the custom external network port to map to the internal network port.</li></ul> |
| Port Description | It specifies the type of the port.   |

| Parameter           | Description   |
|---------------------|---|
| Internal Port       | It specifies the port of the corresponding service of the NVR.<br>You can modify the port number on the <a href="#">Port Configuration</a> page.  |
| External Port       | It specifies the port allows internet users to access.<br>The system presets the external port number. When the port mapping mode is <b>Custom</b> , you can customize the external port number.  |
| External IP Address | It specifies the WAN IP address of the upstream router of the NVR.<br> <b>NOTE</b><br>After the port mapping succeeded, the system will automatically fill in without any configuration.   |
| Status              | It specifies the status of each port mapping. <ul style="list-style-type: none"> <li>– <b>Mapping Succeeded:</b> The internal port is mapped to the external port successfully.</li> <li>– <b>Router UPnP Disabled:</b> The upstream router of the NVR does not enable the UPnP function.</li> <li>– <b>UPnP Disabled:</b> The UPnP function is disabled.</li> <li>– <b>Mapping Failed:</b> The internal port is not mapped to the external port successfully. You are recommended to customize the external port as the uncommon port (1024 - 65535) and check whether the UPnP configuration of the NVR's upstream router is correct..</li> </ul> |
| Operation           | Available in the port mapping mode is <b>Custom</b> .<br>You can customize the external port of the corresponding service.  |

## Internet User Using the IP Address to Access Web UI of the NVR

**Scenario:** Assume that you have set up a monitoring network with an NVR and connected to the internet.

**Requirement:** The user accesses the web UI of the NVR.

**Solution:** Configure the UPnP function to meet this requirement.

Assume that the WAN IP address of the upstream device is 102.33.66.88.

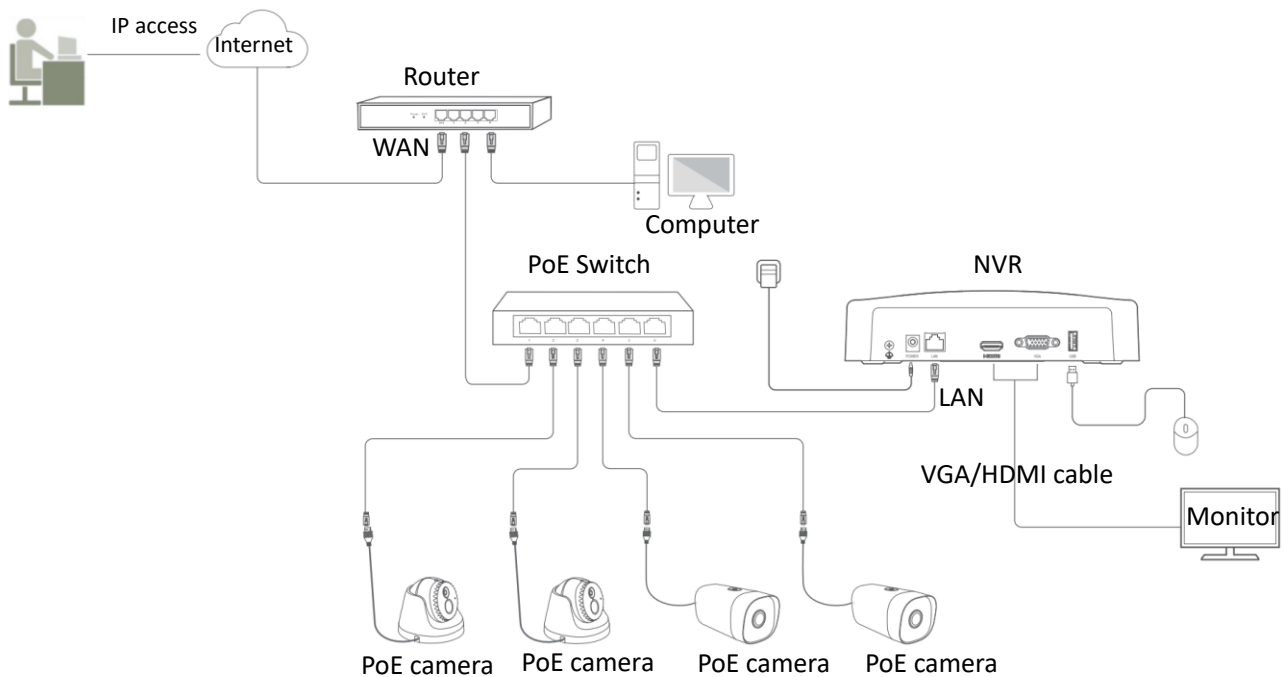

Please ensure that the WAN port of the router obtains a public IP address before configuration.

### Procedure:

- Step 1** [Log in to the GUI of the NVR.](#)
- Step 2** Enable the UPnP function of the NVR.
  1. Navigate to **Configuration > Network > UPnP.**
  2. Set the button to the enabled status  .
  3. Click **Save** .



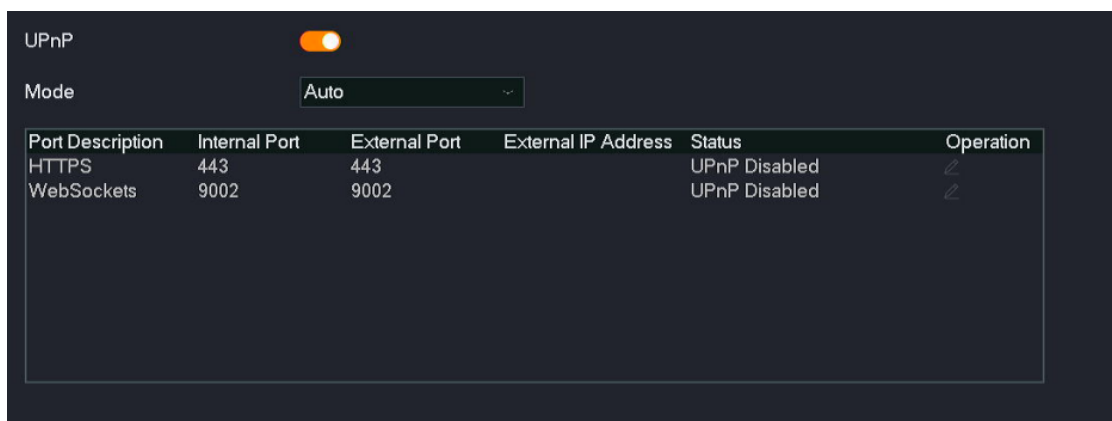

If the port mapping of the HTTPS service fails, try the following solutions:

- Set the mode to **Custom** and customize the external port of HTTPS as the uncommon port (1024-65535). Note: When the external port is modified, the internal port will also be modified synchronously. At this time, when the LAN user uses the IP address of the NVR to access the web UI, the internal port needs to be added. The format is `https://IP address of the NVR: internal port`.
- Check whether the UPnP configuration of NVR's upstream router is correct.

**Step 3** Enable the UPnP function of the router that is in the network.

Please refer to the user guide of the corresponding model for detailed steps.

**---End**

The internet user uses `https://current IP address of WAN port of the router` to successfully access the web UI of the NVR. If the external port of the HTTPS is not the default port, the access format is `https://current IP address of WAN port of the router: external port`.

The access address is `https://102.33.66.88` in this example.

## 4.6.6 System Configuration

On the system configuration page, you can configure the basic information of the NVR, set the system time, manage the login users and configure the live view parameters.

### Basic Configuration

#### Overview

Navigate to **Configuration > System > Basics**.

You can configure the basic parameters of the NVR here, such as device name, language, output resolution, and lock screen password.

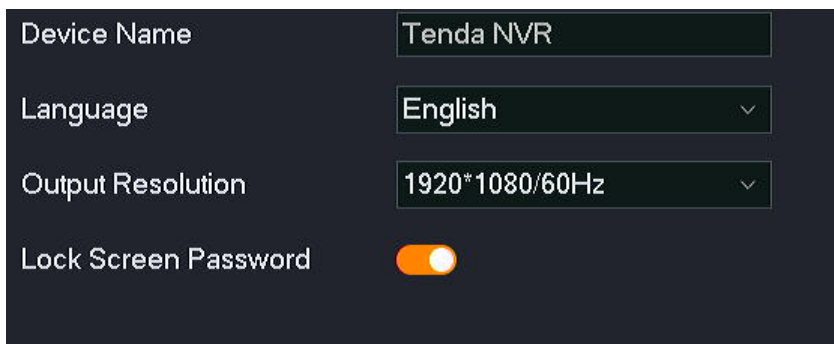

The screenshot shows a configuration interface with four rows. The first row is 'Device Name' with a text input field containing 'Tenda NVR'. The second row is 'Language' with a dropdown menu showing 'English'. The third row is 'Output Resolution' with a dropdown menu showing '1920\*1080/60Hz'. The fourth row is 'Lock Screen Password' with a toggle switch that is turned on (orange).

#### Parameter description

| Parameter            | Description   |
|----------------------|---|
| Device Name          | It specifies the name of the NVR. You can modify it as required.  |
| Language             | It specifies the language displayed on the GUI. You can modify it as required.  |
| Output Resolution    | It specifies the output resolution of the NVR. The resolution of different monitors is different. You can modify it according to the actual situation.  |
| Lock Screen Password | <p>It specifies whether to enable the <b>Lock Screen Password</b> function.</p> <ul style="list-style-type: none"><li>– <b>Enable:</b> The default status. After you enter the GUI of the NVR, if there is no operation within the <a href="#">Lock Screen Time</a> (default: 5 minutes, you can modify it as required), the system will automatically log out and return to the <b>Live View</b> page. If you want to enter the GUI, you need to log in again.</li><li>– <b>Disable:</b> It is not restricted by “Need to log in again when the page is idle for a timeout” unless you log out or reboot the NVR.</li></ul> <p> <b>TIP</b></p> <p>Only administrator account <b>admin</b> is supported.</p> |

## Disable Lock Screen Password

If you do not want to log in again when you enter the GUI even if there is no operation during the **Lock Screen Time**. You can disable the **Lock Screen Password**.

### Procedure:

- Step 1** [Log in to the GUI of the NVR.](#)
- Step 2** Navigate to **Configuration > System > Basics**.
- Step 3** Disable the **Lock Screen Password** function.
- Step 4** Click **Save** at the bottom of the page.

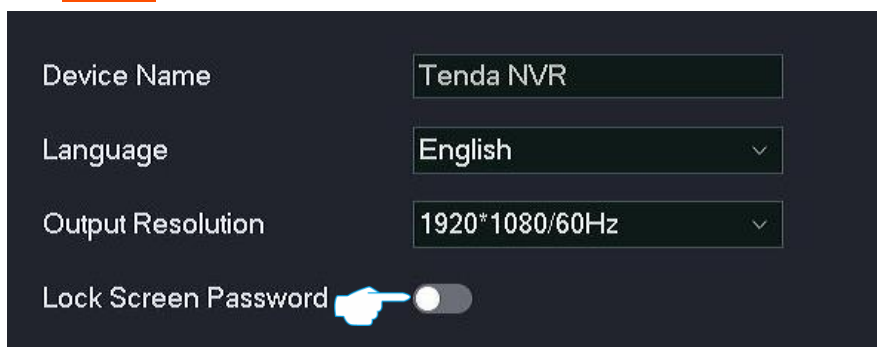

---End

After the setting completes, even if there is no operation during the **Lock Screen Time**, you can enter the GUI without logging in again.

# Time Settings

## Overview

Navigate to **Configuration > System > Time**.

You can set the system time of the NVR here.

To ensure that the time-based functions of the NVR take effect normally, it is necessary to ensure that the system time of the NVR is accurate. The NVR supports two time-setting methods: [Synchronize with the internet](#) and [Manual](#). The default is synchronizing with the internet.

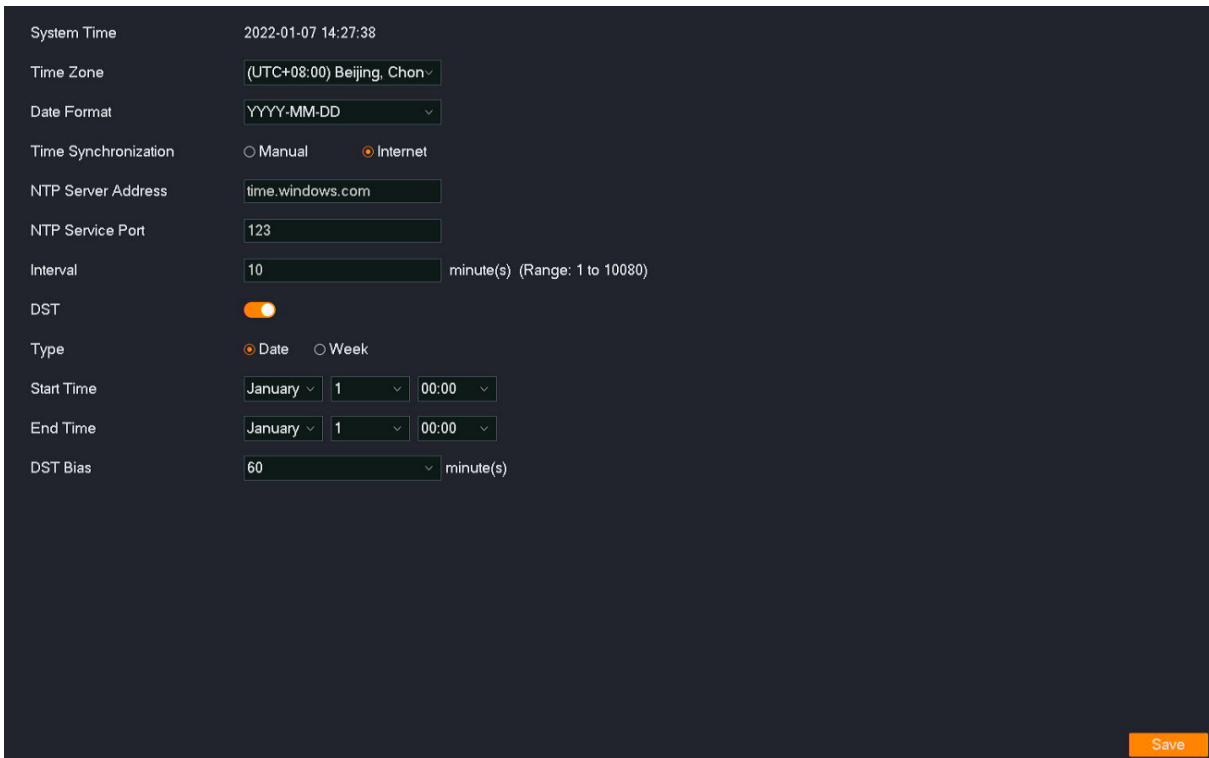

## Parameter description

| Parameter            | Description   |
|----------------------|---|
| System Time          | It specifies the current system time of the NVR.  |
| Time Zone            | It specifies the standard time zone in which the NVR locates.   |
| Date Format          | It specifies the format of the NVR system time.   |
| Time Synchronization | They specify the synchronization mode of the NVR system time. <ul style="list-style-type: none"><li>– <b>Manual:</b> Set the date and time manually.</li><li>– <b>Internet:</b> Synchronize the time of the NTP server according to the interval.</li></ul> |

| Parameter          | Description  |
|--------------------|--|
| Date               | Displayed when <b>Time Synchronization</b> is set to <b>Manual</b> . They are used to manually set the date and time of the NVR.   |
| Time               |  |
| NTP Server Address | Displayed when <b>Time Synchronization</b> is set to <b>Synchronize with the internet</b> .<br>It specifies the address or port of the time server.  |
| NTP Service Port   | Network Time Protocol (NTP) is used to synchronize the time between the client and the network time server.<br>After the <b>Internet</b> function is enabled, the NVR will synchronize the system time through this NTP server according to the <b>Interval</b> .                              |
| Interval           | Displayed when <b>Time Synchronization</b> is set to <b>Synchronize with the internet</b> .<br>It specifies the time interval of the NVR to synchronize the system time to the NTP server.   |
| DST                | It specifies whether to enable the DST function.<br>DST is a time system to save energy. The unified time adopted during the implementation of this system is called <b>DST</b> . If the country or region where the NVR is located implements the DST system, please enable the DST function. |
| Type               | It specifies the type of the DST. Please select according to the local DST system.   |
| Start Time         | They specify the start time and end time of the DST.   |
| End Time           |  |
| DST Bias           | It specifies the time bias during the DST period. For example, the DST system implemented in a country or region is to move the time forward by one hour, the <b>DST Bias</b> should be set to 60 minutes.   |

## Manually Synchronize the System Time

Manually setting the system time of the NVR is generally used when the NVR is disconnected from the internet.

### Method 1

This method is applicable when the professional settings are hidden. When using this method to set the system time, if the NVR is connected to the internet, the system time will automatically synchronize with the NTP server according to the **Interval**.

**Step 1** [Log in to the GUI of the NVR.](#)

- Step 2** Navigate to **Configuration > System > Time**.
- Step 3** (Optional) Select the system time display format.
- Step 4** Set date and time.
- Step 5** Click **Save** at the bottom of the page.

|                      |  |
|----------------------|--|
| Time Zone            | (UTC+08:00) Beijing, Chon  |
| Date Format          | YYYY-MM-DD   |
| Time Synchronization | <input checked="" type="radio"/> Manual <input type="radio"/> Internet |
| Date                 | 2021 - 10 - 30   |
| Time                 | 17 : 32 : 07   |

---End

After the setting is completed, you can click **Show Pro Settings** in the lower-right corner to check whether the **System Time** on the page is accurate.

## Method 2

This method is applicable when the professional settings are displayed.

- Step 1** [Log in to the GUI of the NVR.](#)
- Step 2** Navigate to **Configuration > System > Time**.
- Step 3** (Optional) Select the system time display format.
- Step 4** Set **Time Synchronization**, which is **Manual** in this example.
- Step 5** Set date and time.
- Step 6** Click **Save** at the bottom of the page.

|                      |  |
|----------------------|--|
| System Time          | 2021-10-30 17:32:07  |
| Time Zone            | (UTC+08:00) Beijing, Chon  |
| Date Format          | YYYY-MM-DD   |
| Time Synchronization | <input checked="" type="radio"/> Manual <input type="radio"/> Internet |
| Date                 | 2021 - 10 - 30   |
| Time                 | 17 : 32 : 07   |

---End

After the setting completes, you can check whether the **System Time** on the page is accurate.

## Synchronize the System Time Through Internet

This method is applicable when the professional settings are displayed.

After the NVR is successfully connected to the internet, without settings again, the system time will automatically synchronize with the NTP server according to the **Interval**. You can modify the NTP server and time synchronization according to the actual situation.

Refer to [Internet Settings](#) for the camera accesses to the internet method.

### Procedure:

- Step 1** [Log in to the GUI of the NVR.](#)
- Step 2** Navigate to **Configuration > System > Time**.
- Step 3** Select the time zone in which the NVR locates.
- Step 4** (Optional) Select the system time display format.
- Step 5** Set **Time Synchronization**, which is **Internet** in this example.
- Step 6** Click **Save** at the bottom of the page.

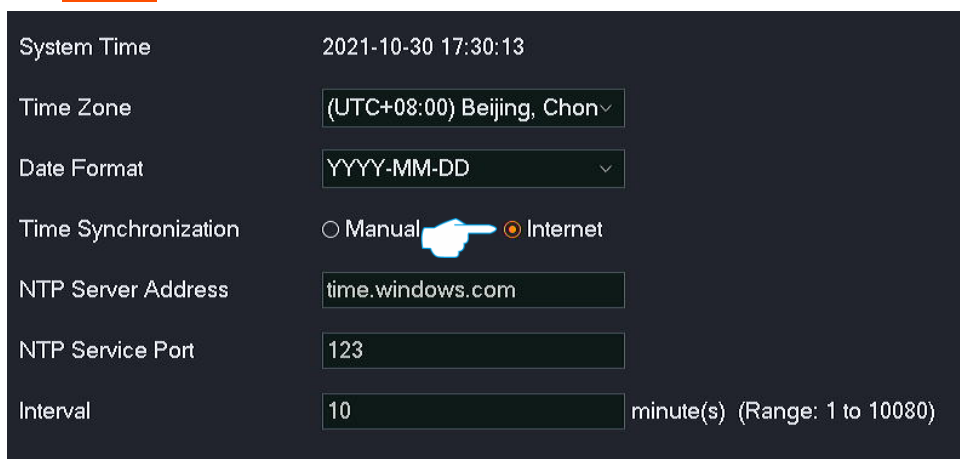

|                      |  |                               |
|----------------------|--|-------------------------------|
| System Time          | 2021-10-30 17:30:13  |                               |
| Time Zone            | (UTC+08:00) Beijing, Chon  |                               |
| Date Format          | YYYY-MM-DD   |                               |
| Time Synchronization | <input type="radio"/> Manual <input checked="" type="radio"/> Internet |                               |
| NTP Server Address   | time.windows.com   |                               |
| NTP Service Port     | 123  |                               |
| Interval             | 10   | minute(s) (Range: 1 to 10080) |

---End

After the setting completes, you can check whether the **System Time** on the page is accurate.

## Enable DST

If the country or region where the NVR is located implements the DST system, please enable the DST function.

### Procedure:

- Step 1** [Log in to the GUI of the NVR.](#)
- Step 2** Navigate to **Configuration > System > Time.**
- Step 3** Find DST, then set the button to the enabled status  .
- Step 4** Select the type of **DST.**
- Step 5** Select the start time and end time of DST.
- Step 6** Set the time bias during the DST period.
- Step 7** Click **Save** at the bottom of the page.

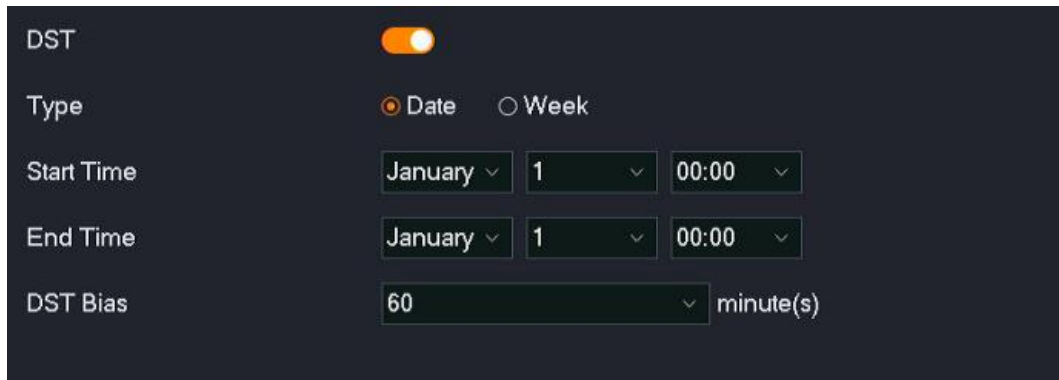

The screenshot shows the DST configuration interface with the following settings:

|            |  |
|------------|--|
| DST        | <input checked="" type="checkbox"/>                              |
| Type       | <input checked="" type="radio"/> Date <input type="radio"/> Week |
| Start Time | January 1 00:00  |
| End Time   | January 1 00:00  |
| DST Bias   | 60 minute(s)   |

---End

After the setting completes, the system time will use the DST system of this time zone in this period you set. You can check whether the **System Time** on the current page is correct.



# User Management

## Overview



Navigate to **Configuration > System > Users**.

You can modify and add the login account information of the NVR here to prevent unauthorized users from entering the GUI of the NVR to change the settings.

| No. | User Name | User Type     | Operation   |
|-----|-----------|---------------|---|
| 1   | admin     | Administrator |  |

### Parameter description

| Parameter | Description  |
|-----------|--|
| No.       | It specifies the number of the login account.            |
| User Name | It specifies the user name allowed to log in to the GUI. |

| Parameter | Description  |
|-----------|--|
| User Type | <p>It specifies the login user type.</p> <ul style="list-style-type: none"> <li>– <b>Administrator:</b> After you log in to the NVR with this type of account, you can add a login account and view or modify all configurations of the NVR.</li> <li>– <b>Common user:</b> After you log in to the NVR with this type of account, you have local authority and channel authority. The allowed authority items are subject to the assignment of the administrator.</li> </ul>  |
| Operation | <p>It is used to perform for the login account.</p> <ul style="list-style-type: none"> <li>– Click  to modify such information as the user name, password and permissions of the account. The administrator account and the common user support different edit items. The actual page prevails.</li> <li>– Click  to delete the account. The administrator account cannot be deleted.</li> </ul> |

The NVR allows an administrator user to add common users and assign permissions to common users. Click **Add** in the lower-right corner to add a login account.

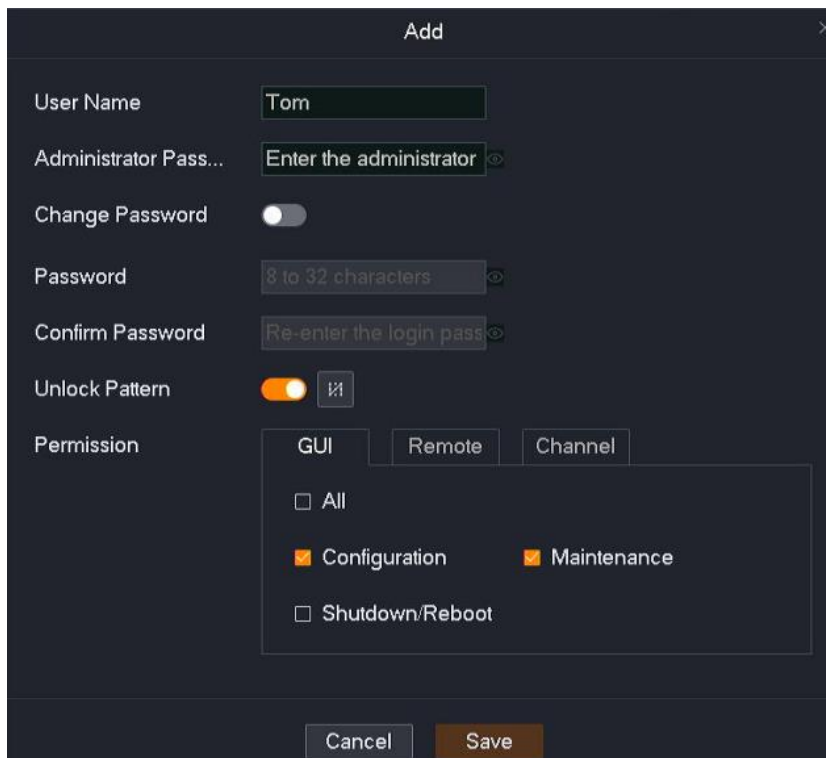

The screenshot shows a dark-themed 'Add' dialog box. The 'User Name' field contains 'Tom'. The 'Administrator Pass...' field contains 'Enter the administrator'. The 'Change Password' toggle is off. The 'Password' field contains '8 to 32 characters'. The 'Confirm Password' field contains 'Re-enter the login pass'. The 'Unlock Pattern' toggle is on, and a pattern icon is visible. The 'Permission' section has three tabs: 'GUI', 'Remote', and 'Channel'. Under the 'GUI' tab, there are four checkboxes: 'All' (unchecked), 'Configuration' (checked), 'Shutdown/Reboot' (unchecked), and 'Maintenance' (checked). At the bottom, there are 'Cancel' and 'Save' buttons.

## Parameter description

| Parameter        | Description   |
|------------------|---|
| User Name        |   |
| Password         | They specify the login user name and password used to enter the GUI.  |
| Confirm Password |   |
| Unlock Pattern   | It specifies whether to use a pattern to log in to the GUI.<br>After it is enabled, you need to draw an unlock pattern by following the instructions.   |
| Permission       | It specifies the permission of the account. <ul style="list-style-type: none"><li>– <b>GUI:</b> It specifies the local operation permission, such as configuration, maintenance, and shutdown or reboot.</li><li>– <b>Remote:</b> It specifies the remote management permission, such as configuration and system management.</li><li>– <b>Channel:</b> It specifies the channels that can be operated and their permissions, such as live view and playback.</li></ul> |

## Add User

Assume that the administrator wants to add a login account for Tom.

The account can be used to:

- Log in to the GUI using a password and pattern.
- Configure and maintain with local permissions.
- Configure operation with remote permissions.
- Preview and play back recordings of channels D1 to D3 with channel permissions.

**Procedure:**

**Step 1** [Log in to the GUI of the NVR.](#)

**Step 2** Navigate to **Configuration > System > Users.**

**Step 3** Add the login user account.

1. Click **Add** at the bottom of the page.
2. Set the user name and password. The following figure is for reference only.
3. Re-enter the login password in **Confirm Password** input box.
4. Enable the **Unlock Pattern** and draw an unlock pattern by following the instruction.

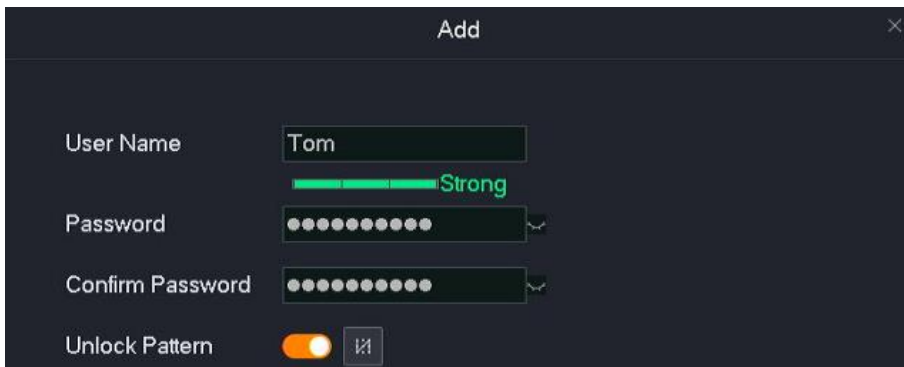

5. Set the management permissions of this account.
  - (1) Set the local permission of this account, which are **Configuration** and **Maintenance** in this example.

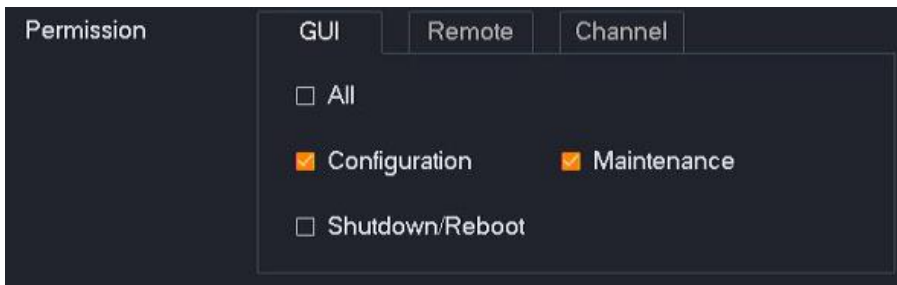

- (2) Click **Remote** and set the remote permission of this account, which is **Configuration** in this example.

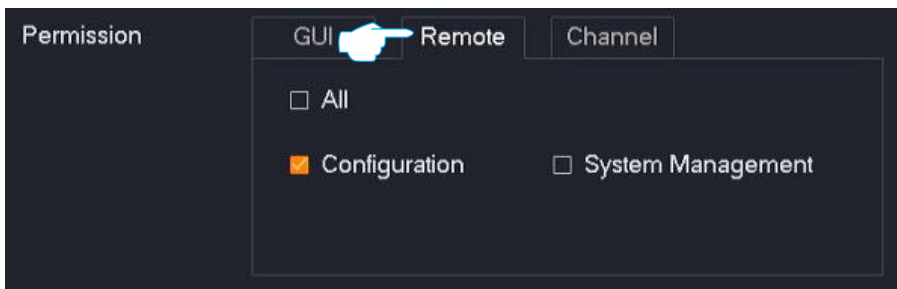

- (3) Click **Channel** and set related permissions, which are **Live view** and **Playback** permission of the D1 to D3 in this example.

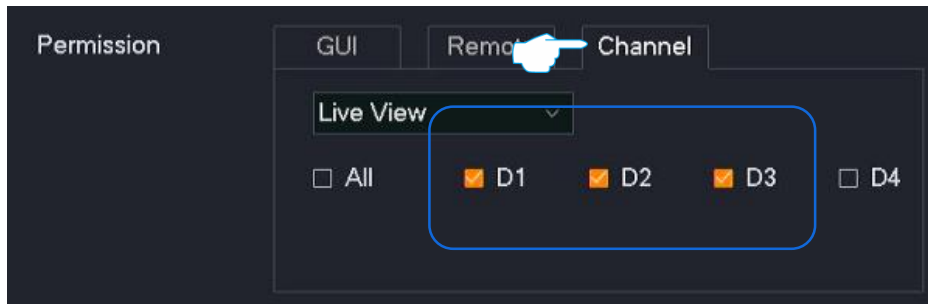

**Step 4** Click **Save**.

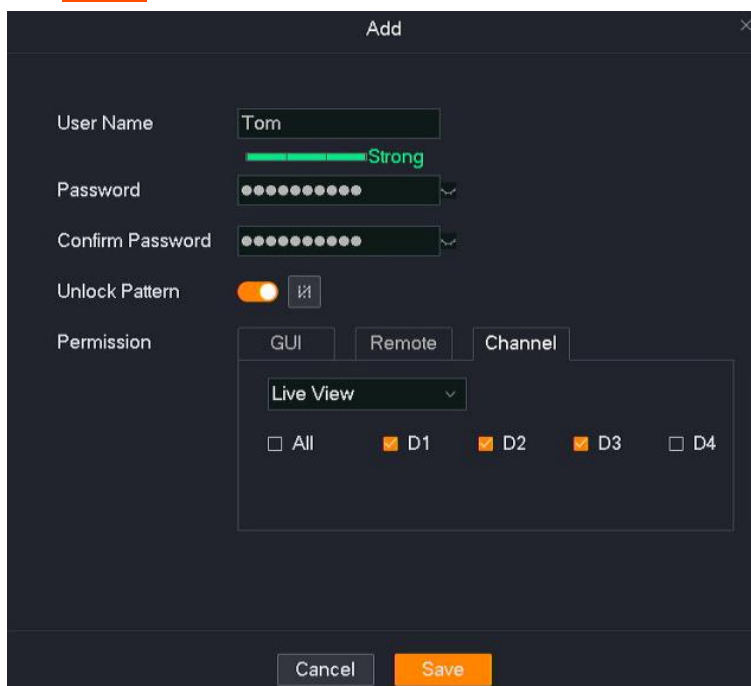

---End

After the setting completes, when you log in with the user name **Tom**, both password and pattern login is supported. During local management, configuration and maintenance can be performed, and the recordings of D1 to D3 can be played back and live viewed. During remote access, the **Configuration** chapter can be operated.

| No. | User Name | User Type     | Operation |
|-----|-----------|---------------|-----------|
| 1   | admin     | Administrator |           |
| 2   | Tom       | Common user   |           |

## Modify User Info

Assume that you want to modify the login unlock pattern of **Tom**.

### Procedure:

**Step 1** [Log in to the GUI of the NVR.](#)

**Step 2** Navigate to **Configuration > System > Users**.

**Step 3** Find the user name of the user for which the login and unlock pattern is to be modified, and click .

| No. | User Name | User Type     | Operation   |
|-----|-----------|---------------|---|
| 1   | admin     | Administrator |    |
| 2   | Tom       | Common user   |   |

**Step 4** Enter the administrator password.

**Step 5** Click the unlock pattern icon , then follow the on-screen instructions to draw an unlock pattern.

**Step 6** Click **Save**.

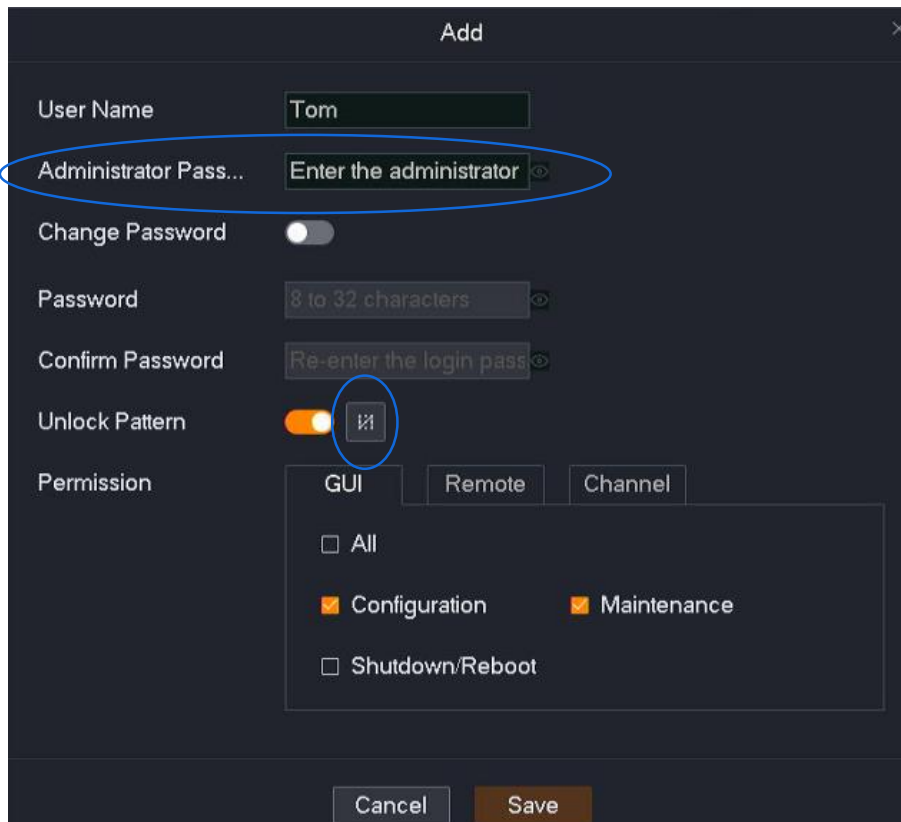

The screenshot shows a dialog box titled "Add" with the following fields and options:

- User Name: Tom
- Administrator Pass...: Enter the administrator password (circled in blue)
- Change Password: Off
- Password: 8 to 32 characters
- Confirm Password: Re-enter the login password
- Unlock Pattern: On (circled in blue)
- Permission: GUI (selected), Remote, Channel
  - All
  - Configuration
  - Maintenance
  - Shutdown/Reboot

Buttons: Cancel, Save

---End

## Live View Configuration

### Overview

Navigate to **Configuration > System > Live View**.

You can modify the live view information of the NVR, including auto-switch dwell time, single-screen alarm dwells time, lock screen time and default live view division.

|                                |   |   |           |
|--------------------------------|---|---|-----------|
| Auto-switch Dwell Time         | 5 | ▼ | second(s) |
| Single Screen Alarm Dwell Time | 5 | ▼ | second(s) |
| Lock Screen Time               | 5 | ▼ | minute(s) |
| Default Live View Division     | 4 | ▼ | screen(s) |

### Parameter description

| Parameter                      | Description  |
|--------------------------------|--|
| Auto-switch Dwell Time         | It specifies the image dwell time during auto-switch live view on the <b>Live View</b> page.   |
| Single Screen Alarm Dwell Time | It specifies the dwell time of the single-screen display of the alarm image when the alarm mode is <b>Single-screen display</b> and an alarm is triggered.   |
| Lock Screen Time               | <p>It specifies the page idle timeout time.</p> <p>After entering the GUI of the NVR, if there is no operation during the <b>Lock Screen Time</b>, the system will automatically log out and return to the <b>Live View</b> page.</p> <p> <b>TIP</b></p> <p>0 indicates that the screen will not be locked.</p> |
| Default Live View Division     | It specifies the default number of division screens for a single screen of the live view page. You can modify it according to the actual situation.  |

## Set Lock Screen Time

Assume that you want to extend the page timeout time.

### Procedure:

**Step 1** [Log in to the GUI of the NVR.](#)

**Step 2** Navigate to **Configuration > System > Live View.**

**Step 3** Select a time from the **Lock Screen Time** drop-down list box, which is **30 minutes** in this example.

**Step 4** Click **Save** at the bottom of the page.



---End

After the setting completes, when you enter the GUI of the NVR, if there is no operation within 30 minutes, the system will automatically log out and return to the **Live View** page. If you want to enter the GUI, you need to log in again.



## 4.7 Maintenance

On the maintenance page, you can check the device information and channel information of the NVR, and can also perform maintenance operations on the NVR, including device upgrade, device log view or export, network detection and device maintenance.

### 4.7.1 Devie Info

Navigate to **Maintenance > Device Info**.

You can view such basic information as device name, device model, software version, software release time and system time of the NVR.

|                  |                             |
|------------------|-----------------------------|
| Device Name      | Tenda NVR                   |
| Device Model     | N3L-4H                      |
| Device S/N       | 2106C5110100000025          |
| Firmware Version | V12.1.3.9                   |
| Release Date     | 2021-12-22                  |
| System Time      | 2022-01-06 17:55:54         |
| Uptime           | 0day(s)00hour(s)38minute(s) |

#### Parameter description

| Parameter        | Description   |
|------------------|---|
| Device Name      | It specifies the name of the NVR.   |
| Device Model     | It specifies the model of the NVR.  |
| Device S/N       | It specifies the S/N of the NVR.  |
| Firmware Version | It specifies the version number of the current system firmware of the NVR.  |
| UUID             | Universal Unique Identifier (UUID), which identifies the uniqueness of the NVR.<br>When an NVR is added through the TDSEE App, you can use the UUID number to add it. |
| Release Date     | It specifies the release time of the current system firmware of the NVR.  |

| Parameter   | Description   |
|-------------|---|
| System Time | It specifies the current system time of the NVR.                              |
| Uptime      | It specifies the time during which the NVR is operating since the last start. |

## 4.7.2 Channel Info

Navigate to **Maintenance > Channel Info**. The N6P-4H is taken as an example here.

You can view such channel information as channel name, camera model, IP address, status and the resolution of the main stream/sub-stream, frame rate and bitrate.

| Channel | Channel Name | IP Address    | Model        | Status   | Resolution | Frame Rate | Bitrate | Encoding |
|---------|--------------|---------------|--------------|----------|------------|------------|---------|----------|
| 1       |              | 192.168.0.140 | TD-L33DS1201 | ● Online | 2560*1440  | 25fps      | 416kbps | H.265    |
| 2       | IC7          | 192.168.0.149 | IC7          | ● Online | 2560*1440  | 25fps      | 416kbps | H.265    |

### Parameter description

| Parameter    | Description  |
|--------------|--|
| Channel      | It specifies the number of channels in which the camera locates. |
| Channel Name | It specifies the name of channels in which the camera locates.   |
| IP Address   | It specifies the IP address of the camera.                       |
| Model        | It specifies the model of the camera.                            |

| Parameter   | Description  |
|-------------|--|
| Status      | <p>It specifies the status of the camera.</p> <ul style="list-style-type: none"> <li>– <b>Connecting... (Logging in...):</b> The NVR is trying to log in to the camera.</li> <li>– <b>Online:</b> The NVR has successfully added a camera, and you can view or manage the camera through the NVR GUI.</li> <li>– <b>Exception:</b> The NVR failed to add a camera. The detailed reasons for the exception are as follows: <ul style="list-style-type: none"> <li>• <b>Camera is offline:</b> The camera is not connected to the NVR.</li> <li>• <b>Network error:</b> The network between the camera and the NVR is disconnected. Please ensure that the network connection between the camera and the NVR is normal, and the network parameters are configured correctly.</li> <li>• <b>Incorrect user name or password:</b> The user name or password of the camera is incorrect.</li> <li>• <b>The user has been locked:</b> The login user of the camera has been locked.</li> </ul> </li> </ul> |
| Stream Type | It specifies the stream type of the camera. Main stream and sub-stream are supported.  |
| Resolution  | It specifies the resolution of the camera video. The higher the resolution, the clearer the image and the more obvious details.  |
| Frame Rate  | It specifies the frame rate of the camera video. The higher the frame rate, the smoother the image.  |
| Bitrate     | It specifies the data traffic used by the camera video file per unit time. The larger the bit rate, the better the picture quality.  |
| Encoding    | It specifies the encoding standard of the camera video.  |

## 4.7.3 Device Upgrade

Navigate to **Maintenance > Device Upgrade**.

The firmware upgrade enables the NVR to get new or more stable performance. The NVR only supports **Local Upgrade** for now.



- To avoid damage to the NVR, please use the correct upgrade file. Generally, the firmware upgrade file is suffixed with .bin.
  - During upgrading, do not directly cut off the power supply of the NVR; it may cause upgrade failure or NVR damage.
- 

### Method 1

It is applicable for the NVR that cannot be connected to the mouse and the USB storage device at the same time.

**Step 1** Visit [www.tendacn.com](http://www.tendacn.com) to download the latest upgrade firmware of the corresponding camera model, and unzip it to the root directory of the USB device.

**Step 2** Save the upgrade file to the root directory of the USB storage device.

---



The NVR can recognize USB storage devices formatted as FAT32, exFAT and NTFS.

---

**Step 3** [Log in to the GUI of the NVR](#) to upgrade firmware.

1. Navigate to **Maintenance > Device Upgrade**, and click **Local Upgrade**.

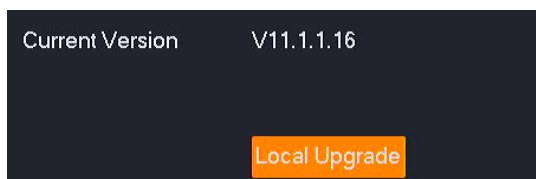

2. Unplug the mouse and connect the USB storage device to the USB port of the NVR within 1 minute.
- 



The system will automatically verify and select the latest version upgrade file in the USB storage device that fits the current NVR model to upgrade.

---

---End

After the system detects the upgrade file, the upgrade starts automatically. Please wait with patience.

After the upgrade completes, unplug the USB storage device, re-plug in the mouse to enter the GUI of the NVR and check the **Current version** of the NVR on the **Device upgrade** page to confirm that it is the same as the firmware version you just upgraded.

## Method 2

It is applicable for the NVR that can be connected to the mouse and the USB storage device at the same time.



If the NVR has only one USB port or the USB port has been used, you need to prepare a USB hub by yourself.

**Step 1** Visit [www.tendacn.com](http://www.tendacn.com) to download the latest upgrade firmware of the corresponding camera model, and unzip it to the root directory of the USB device.

**Step 2** Save the upgrade file to the root directory of the USB storage device.



The NVR can recognize USB storage devices formatted as FAT32, exFAT and NTFS.

**Step 3** [Log in to the GUI of the NVR](#) to upgrade firmware.

1. Navigate to **Maintenance > Device Upgrade**, and click **Local Upgrade**.

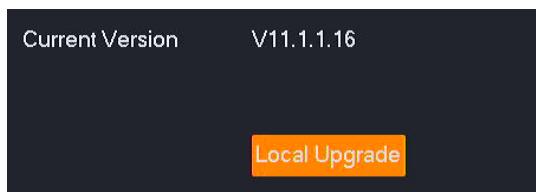

2. Click the drop-down list to select your USB storage device, then select upgrade file (the suffixed with .bin.), and click **Upgrade**.

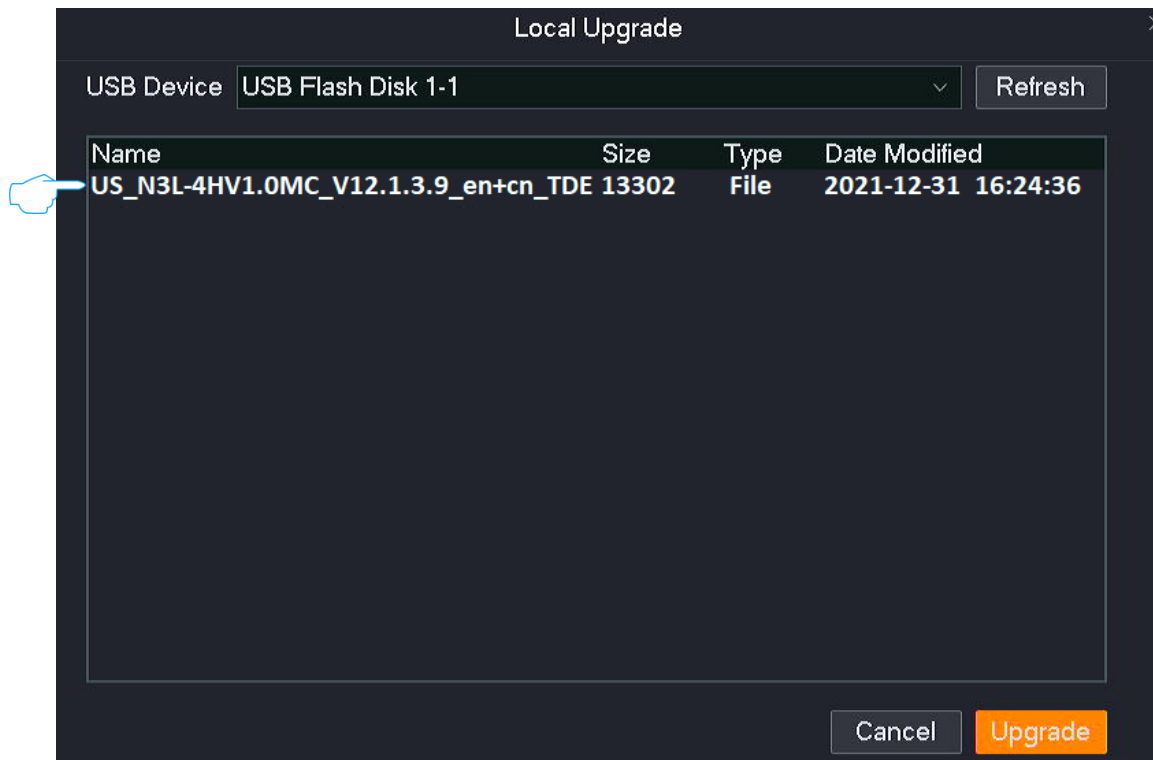

---End

Wait for a moment until the ongoing process finishes. Log in to the GUI of the NVR again. Check the **Current Version** of the NVR on the **Firmware Upgrade** page to confirm that the firmware version of your NVR is the same as the latest firmware version.

## 4.7.4 System Log

### Overview

Navigate to **Maintenance > Device Log**.

The system log records such information as running status, configuration information, alarm information, and exception conditions of the system. You can use system logs for viewing alarm information and troubleshooting. It is recommended to check and back up logs regularly.

The screenshot displays the System Log interface. At the top, there is a filter for 'Type' set to 'All'. Below this are input fields for 'Start Time' (2022-04-06 00:00:00) and 'End Time' (2022-04-07 00:00:00), along with a 'Search' button. The main area contains a table with the following data:

| No. | Time                | Type          | Detail  |
|-----|---------------------|---------------|---|
| 1   | 2022-04-06 08:39:24 | Exception     | IPC Connect Abnormal{"Channel":2,"Result":"Disconnect","State":2}                               |
| 2   | 2022-04-06 08:40:02 | Exception     | IPC Connect Abnormal{"Channel":2,"Result":"Disconnect","State":5}                               |
| 3   | 2022-04-06 08:45:24 | Operation     | Shutdown{"Shutdown Time":"2000-00-00 00:00:00"}   |
| 4   | 2022-04-06 08:45:27 | Operation     | Start Up{"Disk":1,"Flag":1}   |
| 5   | 2022-04-06 08:45:27 | Exception     | Network Failure{"Network Failure":"eth0.1"}   |
| 6   | 2022-04-06 08:45:27 | Exception     | Video Lost{"Channel":"3"}   |
| 7   | 2022-04-06 08:45:27 | Exception     | Video Lost{"Channel":"4"}   |
| 8   | 2022-04-06 08:45:27 | Exception     | IPC Connect Abnormal{"Channel":1,"Result":"Disconnect","State":5}                               |
| 9   | 2022-04-06 08:45:31 | Exception     | IPC Connect Abnormal{"Channel":2,"Result":"Disconnect","State":5}                               |
| 10  | 2022-04-06 09:18:41 | Operation     | Shutdown{"Shutdown Time":"2000-00-00 00:00:00"}   |
| 11  | 2022-04-06 09:18:44 | Operation     | Start Up{"Disk":1,"Flag":1}   |
| 12  | 2022-04-06 09:18:44 | Exception     | IPC Connect Abnormal{"Channel":1,"Result":"Disconnect","State":5}                               |
| 13  | 2022-04-06 09:18:44 | Exception     | Network Failure{"Network Failure":"eth0.1"}   |
| 14  | 2022-04-06 09:18:44 | Exception     | Video Lost{"Channel":"3"}   |
| 15  | 2022-04-06 09:18:44 | Exception     | Video Lost{"Channel":"4"}   |
| 16  | 2022-04-06 09:18:47 | Exception     | IPC Connect Abnormal{"Channel":2,"Result":"Disconnect","State":5}                               |
| 17  | 2022-04-06 09:26:11 | Information   | Network Recovery{"Network Recovery":"eth0.1"}   |
| 18  | 2022-04-06 09:28:47 | Configuration | System Time{"Config Name":"NetNTP","New Time":"2022-04-06 09:28:47"}                            |
| 19  | 2022-04-06 09:45:48 | Operation     | User Login{"Address":"","LoginAs":"Local","Session":"9"}  |
| 20  | 2022-04-06 09:46:50 | Configuration | Modify Configuration{"Config Name":"VideoWidget","New Config":"","Old Config":"","Session":"9"} |
| 21  | 2022-04-06 09:46:50 | Operation     | Shutdown{"Shutdown Time":"2000-00-00 00:00:00"}   |
| 22  | 2022-04-06 09:46:53 | Operation     | Start Up{"Disk":1,"Flag":1}   |
| 23  | 2022-04-06 09:46:53 | Configuration | Modify Configuration{"Config Name":"LoginSet","New Config":"","Old Config":"","Session":"9"}    |
| 24  | 2022-04-06 09:46:53 | Exception     | Video Lost{"Channel":"1"}   |

At the bottom right of the table, it shows 'Total: 114' and navigation controls. Below the table is an 'Export Log' button.

## Check System Log

Assume that you want to check the exception log information from 12:00:00 on October 30, 2021, to 16:00:00 on October 31, 2021.

### Procedure:

**Step 1** [Log in to the GUI of the NVR.](#)

**Step 2** Navigate to **Maintenance > Device Log.**

**Step 3** Set **Type**, which is **Exception** in this example.

**Step 4** Set the **Start Time** and **End Time**, which is **12:00:00 on October 30, 2021**, to **16:00:00 on October 31, 2021**, in this example.

**Step 5** Click **Search**.



---End

After the search completes, you can check the related information as required.

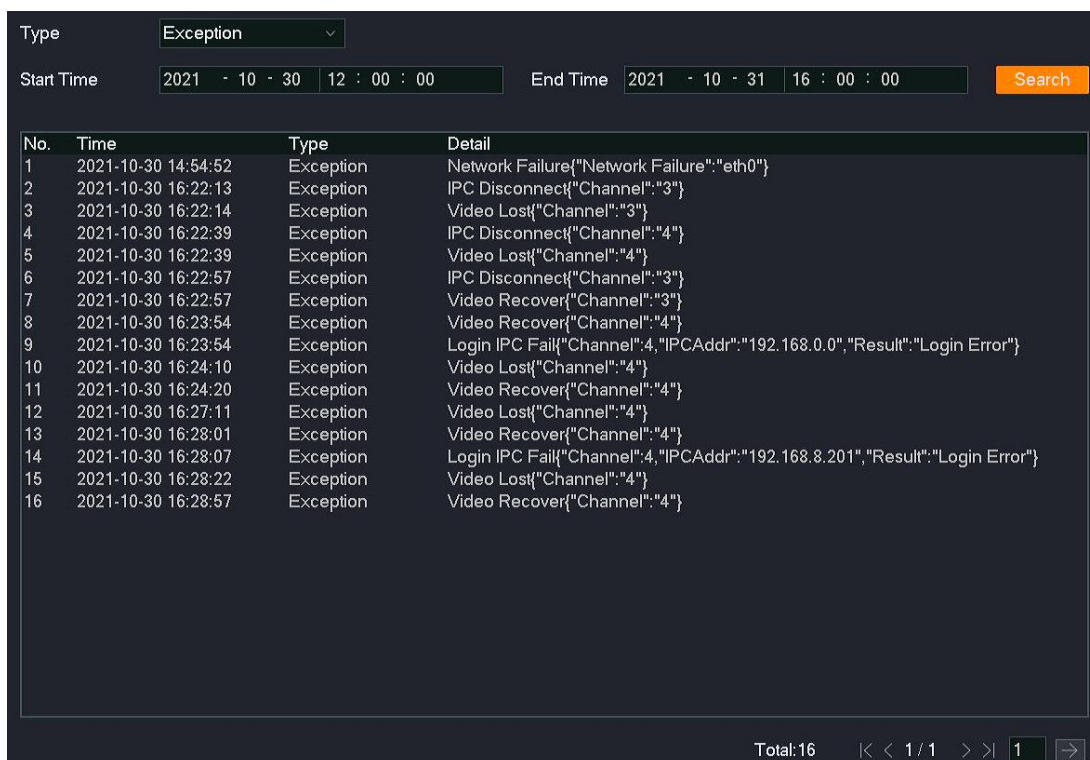

| No. | Time                | Type      | Detail   |
|-----|---------------------|-----------|--|
| 1   | 2021-10-30 14:54:52 | Exception | Network Failure{"Network Failure":"eth0"}                                    |
| 2   | 2021-10-30 16:22:13 | Exception | IPC Disconnect{"Channel":"3"}  |
| 3   | 2021-10-30 16:22:14 | Exception | Video Lost{"Channel":"3"}  |
| 4   | 2021-10-30 16:22:39 | Exception | IPC Disconnect{"Channel":"4"}  |
| 5   | 2021-10-30 16:22:39 | Exception | Video Lost{"Channel":"4"}  |
| 6   | 2021-10-30 16:22:57 | Exception | IPC Disconnect{"Channel":"3"}  |
| 7   | 2021-10-30 16:22:57 | Exception | Video Recover{"Channel":"3"}   |
| 8   | 2021-10-30 16:23:54 | Exception | Video Recover{"Channel":"4"}   |
| 9   | 2021-10-30 16:23:54 | Exception | Login IPC Fail{"Channel":4,"IPCAddr":"192.168.0.0","Result":"Login Error"}   |
| 10  | 2021-10-30 16:24:10 | Exception | Video Lost{"Channel":"4"}  |
| 11  | 2021-10-30 16:24:20 | Exception | Video Recover{"Channel":"4"}   |
| 12  | 2021-10-30 16:27:11 | Exception | Video Lost{"Channel":"4"}  |
| 13  | 2021-10-30 16:28:01 | Exception | Video Recover{"Channel":"4"}   |
| 14  | 2021-10-30 16:28:07 | Exception | Login IPC Fail{"Channel":4,"IPCAddr":"192.168.8.201","Result":"Login Error"} |
| 15  | 2021-10-30 16:28:22 | Exception | Video Lost{"Channel":"4"}  |
| 16  | 2021-10-30 16:28:57 | Exception | Video Recover{"Channel":"4"}   |

Total: 16 << 1 / 1 >> 1



## Export System Log

Assume that you want to check the exception log information from 12:00:00 on October 30, 2021 to 16:00:00 on October 31, 2021.



The NVR can recognize USB storage devices formatted as FAT32, exFAT and NTFS.

### Method 1

It is applicable for the NVR cannot be connected to the mouse and the USB storage device at the same time.

**Step 1** [Log in to the GUI of the NVR.](#)

**Step 2** Navigate to **Maintenance > Device Log.**

**Step 3** Set **Type**, which is **Exception** in this example.

**Step 4** Set the **Start Time** and **End Time**, which is **12:00:00 on October 30, 2021**, to **16:00:00 on October 31, 2021**, in this example.

**Step 5** Click **Search** .

Type: Exception  
Start Time: 2021 - 10 - 30 12 : 00 : 00    End Time: 2021 - 10 - 31 16 : 00 : 00    Search

**Step 6** Click **Export Log** at the bottom of the page.

| No. | Time                | Type      | Detail  |
|-----|---------------------|-----------|---|
| 1   | 2021-10-30 14:54:52 | Exception | Network Failure{"Network Failure":"eth0"}                                       |
| 2   | 2021-10-30 16:22:13 | Exception | IPC Disconnect{"Channel":"3"}   |
| 3   | 2021-10-30 16:22:14 | Exception | Video Lost{"Channel":"3"}   |
| 4   | 2021-10-30 16:22:39 | Exception | IPC Disconnect{"Channel":"4"}   |
| 5   | 2021-10-30 16:22:39 | Exception | Video Lost{"Channel":"4"}   |
| 6   | 2021-10-30 16:22:57 | Exception | IPC Disconnect{"Channel":"3"}   |
| 7   | 2021-10-30 16:22:57 | Exception | Video Recover{"Channel":"3"}  |
| 8   | 2021-10-30 16:23:54 | Exception | Video Recover{"Channel":"4"}  |
| 9   | 2021-10-30 16:23:54 | Exception | Login IPC Fail{"Channel":"4","IPCAAddr":"192.168.0.0","Result":"Login Error"}   |
| 10  | 2021-10-30 16:24:10 | Exception | Video Lost{"Channel":"4"}   |
| 11  | 2021-10-30 16:24:20 | Exception | Video Recover{"Channel":"4"}  |
| 12  | 2021-10-30 16:27:11 | Exception | Video Lost{"Channel":"4"}   |
| 13  | 2021-10-30 16:28:01 | Exception | Video Recover{"Channel":"4"}  |
| 14  | 2021-10-30 16:28:07 | Exception | Login IPC Fail{"Channel":"4","IPCAAddr":"192.168.8.201","Result":"Login Error"} |
| 15  | 2021-10-30 16:28:22 | Exception | Video Lost{"Channel":"4"}   |
| 16  | 2021-10-30 16:28:57 | Exception | Video Recover{"Channel":"4"}  |

Total:16    << 1 / 1 >> 1

Export Log

**Step 7** Unplug the mouse and connect the USB storage device to the USB port of the NVR within 1 minute.

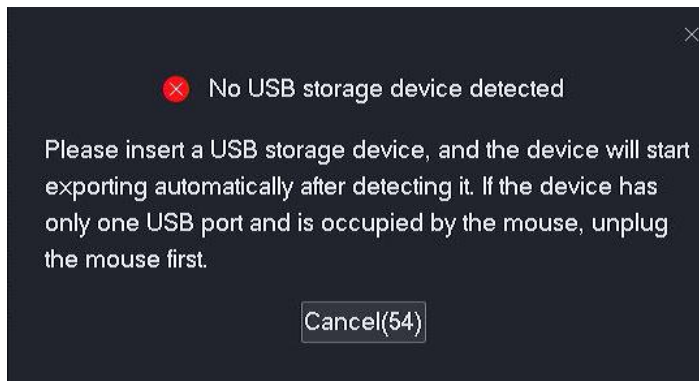

**---End**

The system log with the suffix of .txt will be exported to the root directory of the USB storage device.

## Method 2

It is applicable for the NVR that can be connected to the mouse and the USB storage device at the same time.



If the NVR has only one USB port or the USB port has been used, you need to prepare a USB hub by yourself.

**Step 1** Connect the USB storage device to the USB port of the NVR.

**Step 2** [Log in to the GUI of the NVR](#), and export the system log.

1. Navigate to **Maintenance > Device Log**.
2. Set **Type**, which is **Exception** in this example.
3. Set the **Start Time** and **End Time**, which is **12:00:00** on **October 30, 2021** to **16:00:00** on **October 31, 2021** in this example.
4. Click **Search**, and click **Export Log** at the bottom of the page.

| No. | Time                | Type      | Detail  |
|-----|---------------------|-----------|---|
| 1   | 2021-10-30 14:54:52 | Exception | Network Failure{"Network Failure":"eth0"}                                   |
| 2   | 2021-10-30 16:22:13 | Exception | IPC Disconnect{"Channel":"3"}   |
| 3   | 2021-10-30 16:22:14 | Exception | Video Lost{"Channel":"3"}   |
| 4   | 2021-10-30 16:22:39 | Exception | IPC Disconnect{"Channel":"4"}   |
| 5   | 2021-10-30 16:22:39 | Exception | Video Lost{"Channel":"4"}   |
| 6   | 2021-10-30 16:22:57 | Exception | IPC Disconnect{"Channel":"3"}   |
| 7   | 2021-10-30 16:22:57 | Exception | Video Recover{"Channel":"3"}  |
| 8   | 2021-10-30 16:23:54 | Exception | Video Recover{"Channel":"4"}  |
| 9   | 2021-10-30 16:23:54 | Exception | Login IPC Fail{"Channel":4,"IPAddr":"192.168.0.0","Result":"Login Error"}   |
| 10  | 2021-10-30 16:24:10 | Exception | Video Lost{"Channel":"4"}   |
| 11  | 2021-10-30 16:24:20 | Exception | Video Recover{"Channel":"4"}  |
| 12  | 2021-10-30 16:27:11 | Exception | Video Lost{"Channel":"4"}   |
| 13  | 2021-10-30 16:28:01 | Exception | Video Recover{"Channel":"4"}  |
| 14  | 2021-10-30 16:28:07 | Exception | Login IPC Fail{"Channel":4,"IPAddr":"192.168.8.201","Result":"Login Error"} |
| 15  | 2021-10-30 16:28:22 | Exception | Video Lost{"Channel":"4"}   |
| 16  | 2021-10-30 16:28:57 | Exception | Video Recover{"Channel":"4"}  |

Total: 16 << < 1 / 1 > > 1 >

**Export Log**

5. Click the drop-down list of the **USB Device** to select your USB storage device, and click **Export**.

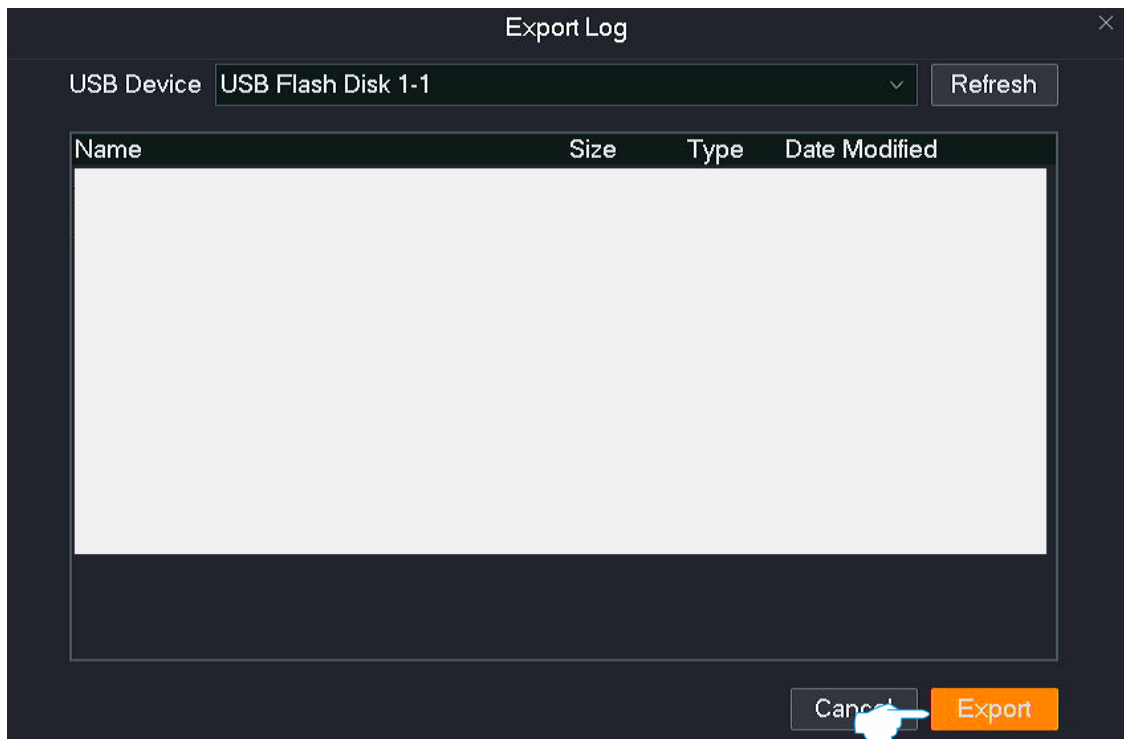

---End

The system log with the suffix of .txt will be exported to the root directory of the USB storage device.

## 4.7.5 Diagnosis

### Overview

Navigate to **Maintenance > Diagnosis**.

You can check the bandwidth usage of the NVR and perform network detection here.

The screenshot displays the 'Diagnosis' interface with the following elements:

- Input Bandwidth:** A progress bar showing 1.6Mbps used (orange) and 58.4Mbps available (grey).
- Output Bandwidth:** A progress bar showing 0.2Mbps used (orange) and 59.8Mbps available (grey).
- One-key Diagnosis:** A prominent orange button labeled 'One-key Diagnosis'.
- Custom Diagnosis:** Radio buttons for 'Ping' (selected) and 'Traceroute'.
- Target Address:** A text input field containing 'IP address/Domain name'.
- Packet Size:** A text input field containing '64'.
- Packet Number:** A text input field containing '4'.
- Start:** A button to initiate the diagnostic test.

#### Parameter description

| Parameter         | Description  |
|-------------------|--|
| Input Bandwidth   | It specifies the usage of the NVR input bandwidth (used for receiving data from cameras). Cameras cannot be added when the bandwidth is used up.                                       |
| Output Bandwidth  | It specifies the usage of the NVR output bandwidth (used for forwarding data from cameras). Remote live view, playback and download cannot be conducted when the bandwidth is used up. |
| One-key Diagnosis | It is used to diagnose the network connectivity and network quality of all channels.   |

| Parameter        | Description   |
|------------------|---|
| Custom Diagnosis | <p>It specifies the network diagnosis method.</p> <ul style="list-style-type: none"> <li>– <b>Ping:</b> Used to check whether the connection is correct and the connection quality.</li> <li>– <b>Traceroute:</b> Used to detect the route from the NVR to the destination IP address.</li> </ul>                         |
| Target Address   | It specifies the target address to be detected. IP address and domain name are supported.   |
| Packet Size      | It specifies the size of a single data packet. It is available only when <b>Custom Diagnosis</b> is set to <b>Ping</b> .  |
| Packet Number    | It specifies the number of data packets detected by a single Ping. It is available only when <b>Custom Diagnosis</b> is set to <b>Ping</b> .  |
| Max. Hop         | <p>It is available only when <b>Custom Diagnosis</b> is set to <b>Traceroute</b>.</p> <p>It specifies the maximum number of hops (maximum lifetime) detected by Traceroute. It means the maximum number of routes that a data packet can pass to reach the destination IP address after it leaves the LAN of the NVR.</p> |

## Execute One-key Diagnosis

Assume that you want to diagnose the network connectivity and network quality of all channels.

### Procedure:

**Step 1** [Log in to the GUI of the NVR.](#)

**Step 2** Navigate to **Maintenance > Diagnosis**.

**Step 3** Click **One-key Diagnosis**.

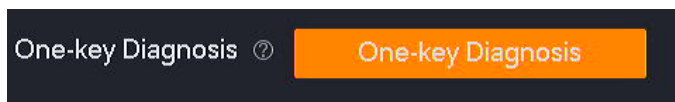

---End

The diagnosis result is displayed on the right side of the page. See the following figure.

| Network Connectivity       |           |
|----------------------------|-----------|
| Gateway connectivity       | Connected |
| Internet connectivity      | Connected |
| Cloud service connectivity | Connected |

| Channel Network Quality |         |     |
|-------------------------|---------|-----|
| Channel                 | Delay   | PLR |
| D1                      | 4.69ms  | 0%  |
| D2                      | 6.09ms  | 0%  |
| D3                      | 13.66ms | 0%  |

**Parameter description**

| Parameter               | Description   |
|-------------------------|---|
| Network Connectivity    | Gateway Connectivity<br>It specifies the connectivity between the NVR and the gateway.                  |
|                         | Internet Connectivity<br>It specifies the connectivity of the NVR to the internet.                      |
|                         | Cloud Service Connectivity<br>It specifies the connectivity between the NVR and the cloud platform.     |
| Channel Network Quality | Channel<br>It specifies the NVR channel number.   |
|                         | Delay<br>It specifies the average round-trip time taken for the data packet between the NVR and camera. |
|                         | PLR<br>It specifies the ratio of the total number of packets lost to the total number of packets sent.  |

**Execute Ping Command to Detect Connection Quality**

Assume that you want to detect whether the link between the NVR and Facebook (www.facebook.com) is unblocked.

**Procedure:**

- Step 1** [Log in to the GUI of the NVR.](#)
- Step 2** Navigate to **Maintenance > Diagnosis.**
- Step 3** Set **Custom Diagnosis**, which is **Ping** in this example.

**Step 4** Enter the destination IP address or domain name, which is **facebook.com** in this example.

**Step 5** Enter the ping packet size. The default value is recommended.

**Step 6** Enter the number of ping packets. The default value is recommended.

**Step 7** Click **Start**.

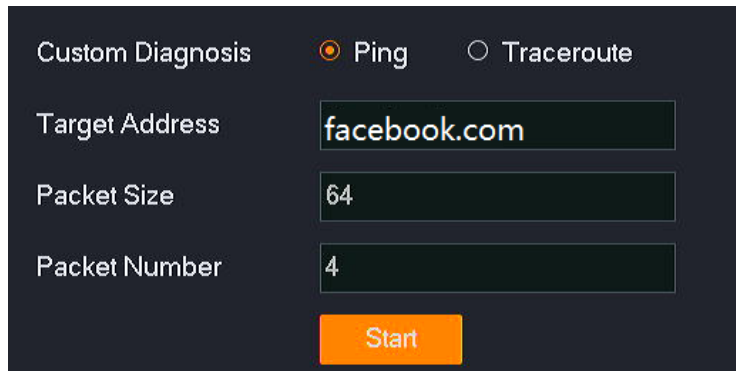

The screenshot shows a 'Custom Diagnosis' window with two radio buttons: 'Ping' (selected) and 'Traceroute'. Below the radio buttons are three input fields: 'Target Address' containing 'facebook.com', 'Packet Size' containing '64', and 'Packet Number' containing '4'. At the bottom of the window is an orange 'Start' button.

---End

The diagnosis result is displayed on the right side of the page. See the following figure.

```
PING 218.93.250.18 (218.93.250.18): 56 data bytes

Ping statistics for 218.93.250.18:
Packets: Sent = 4, Received = 0, Lost = 4 (100% loss)
Approximate round trip times in milli-seconds:
Minimum = 0.0ms, Maximum = 0.0ms, Average = 0.0ms
```

## Execute Traceroute Command to Detect Connection Quality

Assume that you want to detect whether the link between the NVR and Facebook (www.facebook.com) is unblocked.

### Procedure:

**Step 1** [Log in to the GUI of the NVR.](#)

**Step 2** Navigate to **Maintenance > Diagnosis**.

**Step 3** Set **Custom Diagnosis**, which is **Traceroute** in this example.



**Step 4** Enter the destination IP address or domain name, which is **facebook.com** in this example.

**Step 5** Enter the number of hops. The default value is recommended.

**Step 6** Click **Start**.

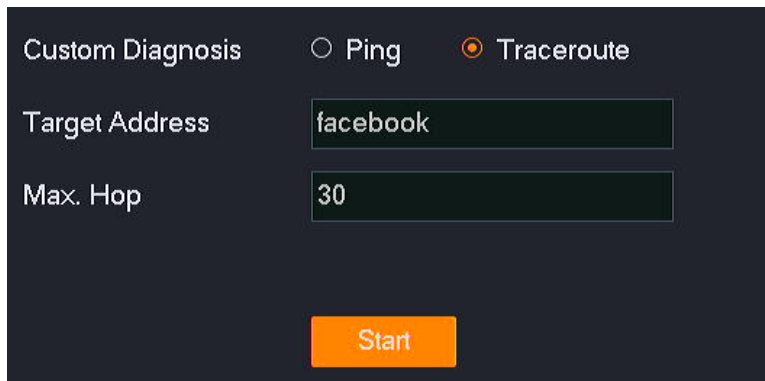

Custom Diagnosis     Ping     Traceroute

Target Address    facebook

Max. Hop    30

Start

---End

The diagnosis result is displayed on the right side of the page. See the following figure.

```
traceroute to facebook (218.93.250.18), 31 hops max, 38 byte packets
 1 192.168.0.1 (192.168.0.1) 0.225 ms 0.169 ms 0.143 ms
 2 172.16.200.1 (172.16.200.1) 1.080 ms 0.872 ms 0.676 ms
 3 192.168.20.1 (192.168.20.1) 1.728 ms 1.543 ms 1.620 ms
 4 192.168.21.254 (192.168.21.254) 1.537 ms 0.977 ms 0.885 ms
 5 113.87.160.1 (113.87.160.1) 18.380 ms 3.145 ms 2.640 ms
 6 233.106.38.59.broad.fs.gd.dynamic.163data.com.cn (59.38.106.233) 4.617 ms 229.106.3
 8.59.broad.fs.gd.dynamic.163data.com.cn (59.38.106.229) 10.058 ms 14.147.74.33 (14.147
 7 14.147.127.105 (14.147.127.105) 3.939 ms 14.147.127.85 (14.147.127.85) 7.690 ms *
 8 202.97.42.202 (202.97.42.202) 29.558 ms 202.97.29.74 (202.97.29.74) 44.325 ms 202.97.
 2.33 (202.97.2.33) 30.013 ms
 9 61.147.248.18 (61.147.248.18) 29.262 ms 61.147.245.74 (61.147.245.74) 34.923 ms 61.1
 47.245.90 (61.147.245.90) 36.783 ms
10 222.187.235.201 (222.187.235.201) 51.313 ms 45.905 ms *
11 61.147.244.126 (61.147.244.126) 55.602 ms 61.147.244.90 (61.147.244.90) 39.826 ms 4
```

## 4.7.6 Device Maintenance

Navigate to **Maintenance > Device Maintenance**.

You can perform maintenance operations on the NVR here, such as enabling or disabling SSH debugging, scheduled reboot, restoring default settings, and restoring factory settings.

### SSH Debugging

Secure Shell (SSH) is a protocol used to realize secure remote access and file transfer services through encryption mechanisms and authentication mechanisms. This NVR supports the SSH

server function and accepts SSH client connections.

By default, SSH debugging is disabled.

After SSH debugging is enabled, you can log in to the NVR through the SSH client. The SSH debugging is only used by professionals to debug the NVR. For security, please do not enable this function unless special situation.



## Set Scheduled Reboot

The scheduled reboot can prevent performance decrease and instability of the NVR due to long-time running. You can set the NVR to automatically reboot periodically during idle time, for example, set the NVR to automatically reboot at 3:00:00 from Monday to Friday.

### Procedure:

- Step 1** [Log in to the GUI of the NVR.](#)
- Step 2** Navigate to **Maintenance > Maintenance.**
- Step 3** Enable the **Scheduled Reboot** function.
- Step 4** Select the reboot date, which is **Monday to Friday** in this example.
- Step 5** Set the reboot time, which is **03:00:00** in this example.
- Step 6** Click **Save** at the bottom of the page.

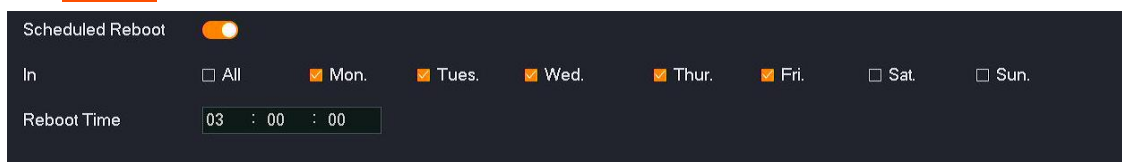

---End

After the setting completes, the NVR will automatically reboot from Monday to Friday at 3:00 am.

## Restore Settings

If the NVR is running slowly, or a configuration error occurs, you can try to restore the NVR.

- Restore the default settings: Except for the network configuration and user management-related configuration, all other settings are restored to the factory settings.
- Restore factory settings: Restore all settings of the NVR to the factory settings.



- When the NVR restores its settings, it will disconnect all current connections.
  - Restoring the settings will not delete recordings and log information.
  - To avoid damaging the NVR, please ensure that the NVR is powered on properly during the process of restoring the factory settings.
- 

### Procedure:

**Step 1** [Log in to the GUI of the NVR.](#)

**Step 2** Navigate to **Maintenance > Device Maintenance**.

**Step 3** Click **Restore Default Settings** or **Restore Factory Settings** according to the actual situation.

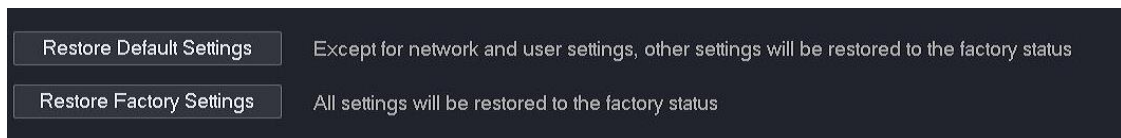

**Step 4** Read the prompt message, and click **OK**.

**---End**

Wait until the progress bar completes.

# 5 Web Management

## 5.1 Web Login

### Scenario 1: With DHCP Server in the Network

**Step 1** Connect the computer to the switch or router that is connected to the NVR.

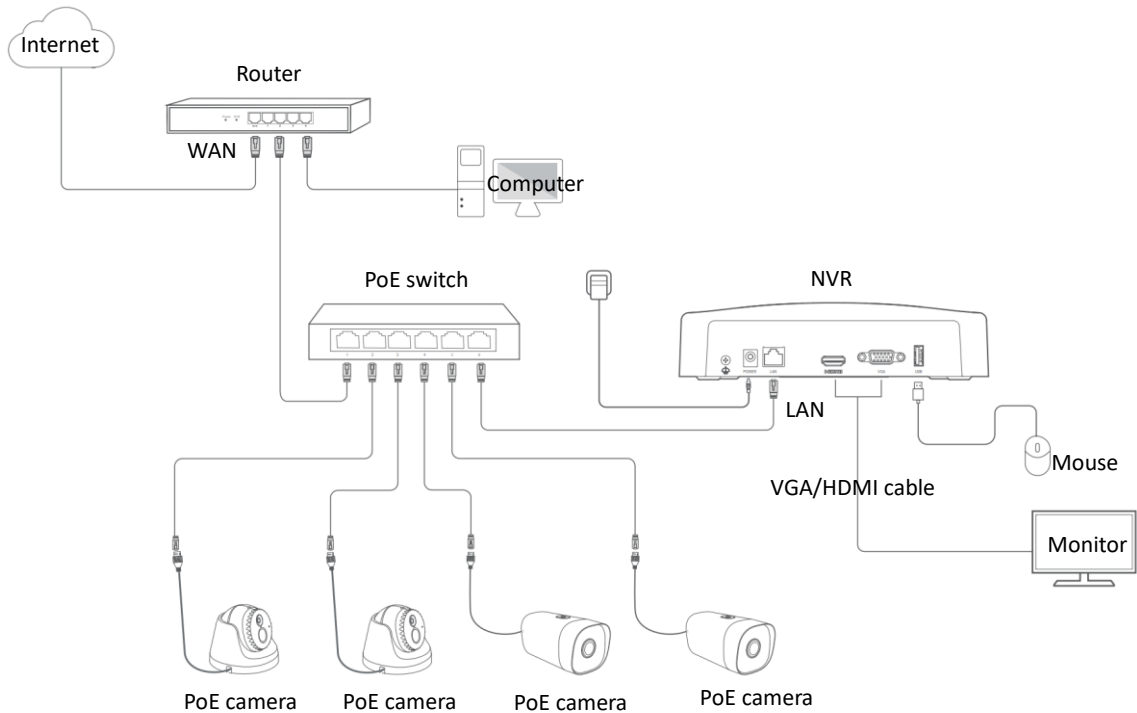

**Step 2** Log in to the web UI of the DHCP to view the IP address of the NVR.

**Step 3** Start a web browser on the computer, and input the IP address (which is 192.168.0.188 in this example) of the NVR in the address bar.

The NVR supports HTTPS secure login. When you access the web UI of the NVR, the browser may prompt that the address is not safe, just ignore it and continue. For example, in Google Chrome, click **Advanced**, and then click **Proceed to 192.168.0.188 (unsafe)**.

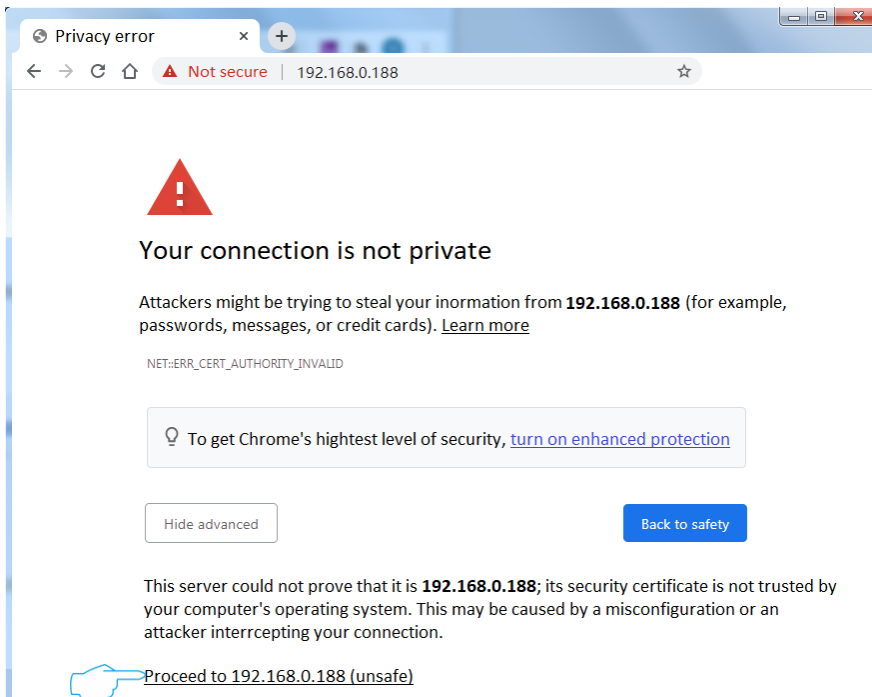
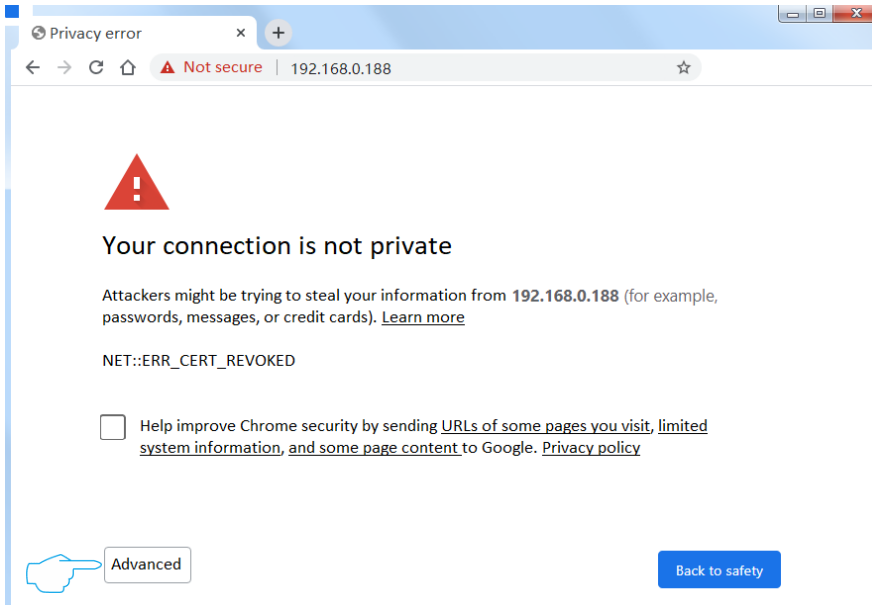

**Step 4** Enter the **Login User Name** and **Login Password**, and click **Login**.

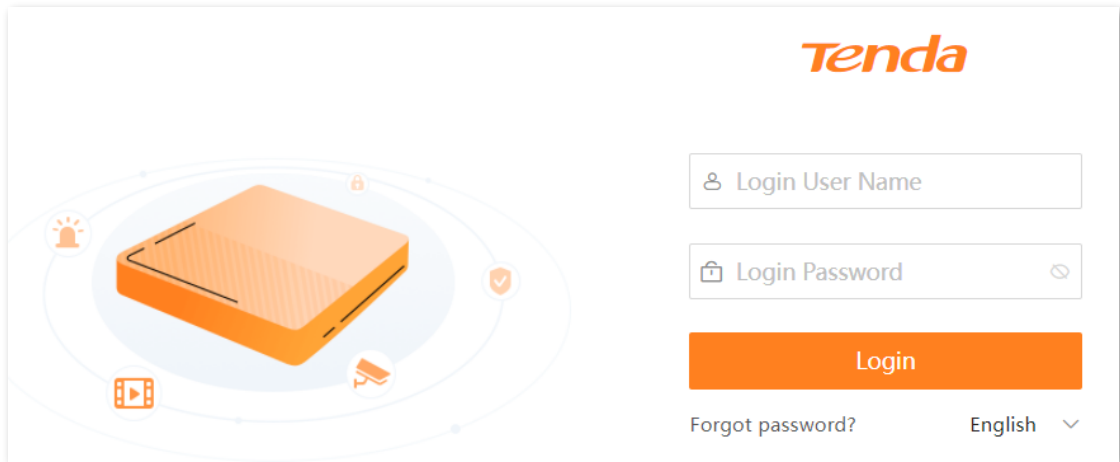

**---End**

After you successfully log in to the web UI of the NVR, you can preview real-time videos or configure them as required.

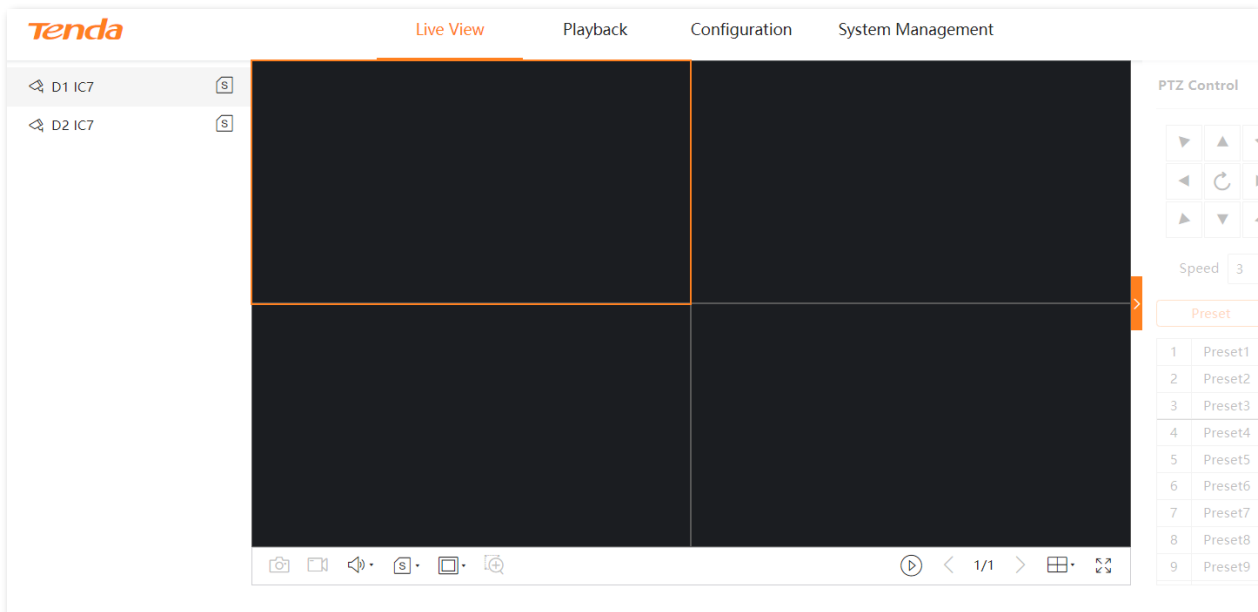

## Scenario 2: Without DHCP Server in the Network

**Step 1** Connect the computer to the switch or router that is connected to the NVR.

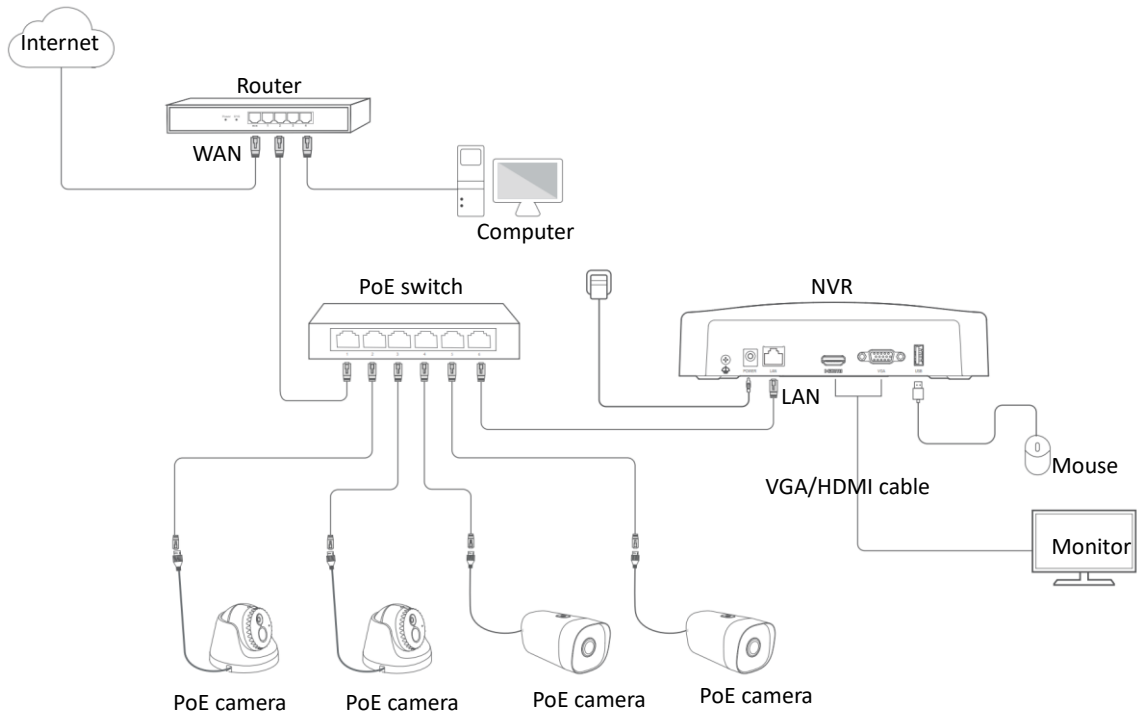

**Step 2** Set the IP address of the computer to an unused one belonging to the same network segment of the IP address (default: 192.168.1.254) of the NVR but different from the IP address of the NVR.

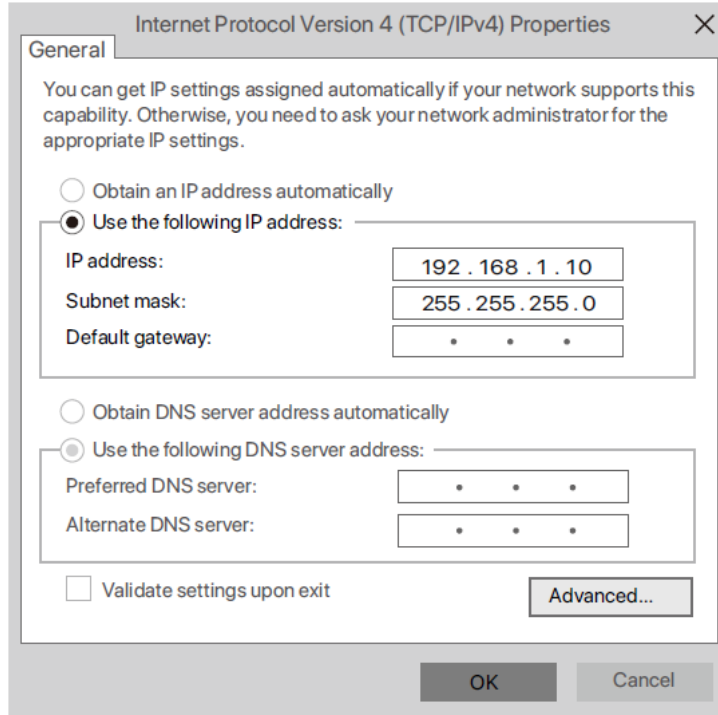



**Step 3** Start a web browser on the computer, and input the IP address of the NVR (default: 192.168.1.254).

The NVR supports HTTPS secure login. When you access the web UI of the NVR, the browser may prompt that the address is not safe, just ignore it and continue. For example, in Google Chrome, click **Advanced**, and then click **Proceed to 192.168.1.254 (unsafe)**.

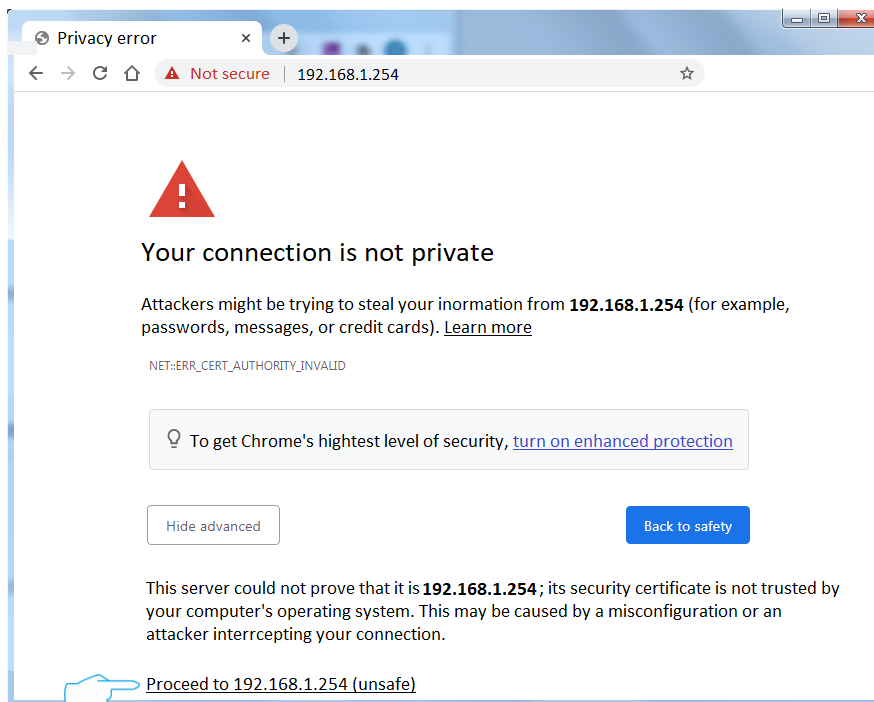
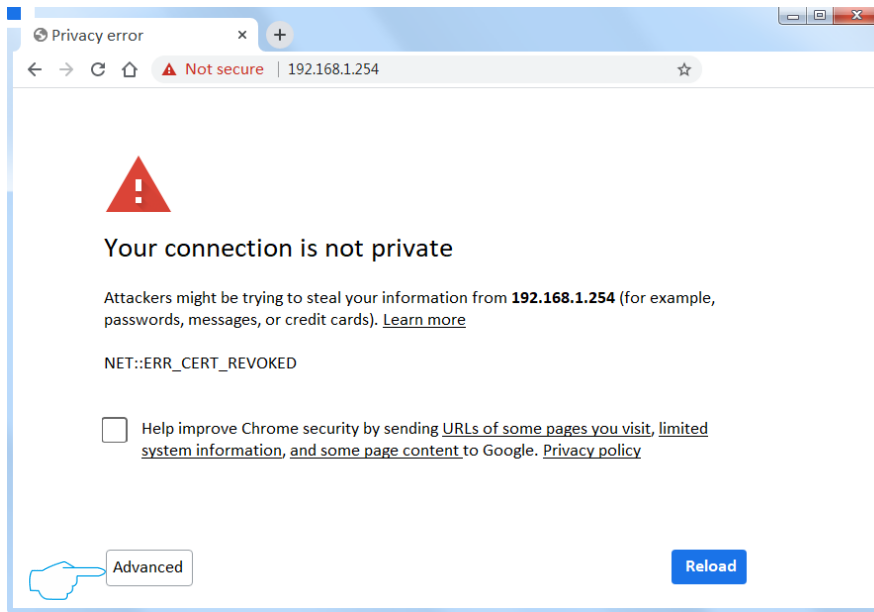

**Step 4** Enter the **Login User Name** and **Login Password**, and click **Login**.

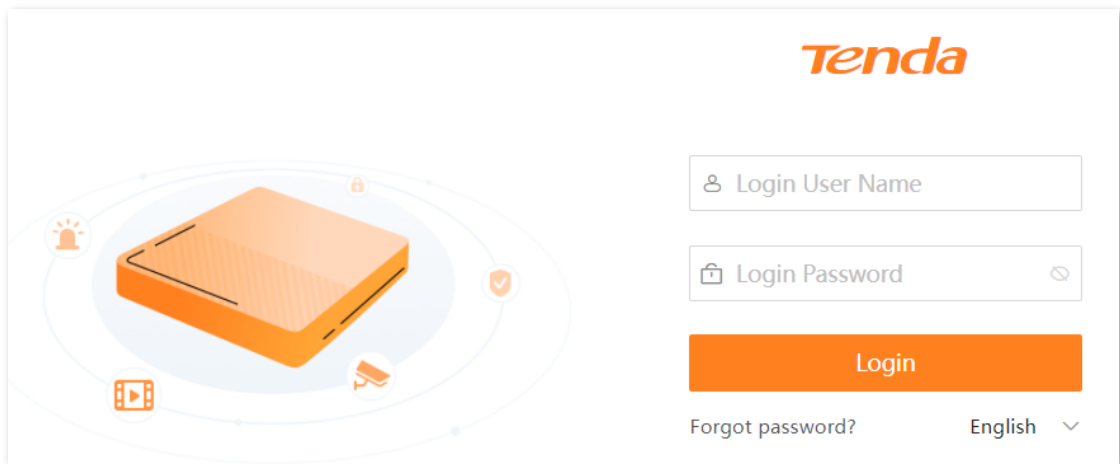

**---End**

After you successfully log in to the web UI of the NVR, you can preview real-time videos or configure them as required.

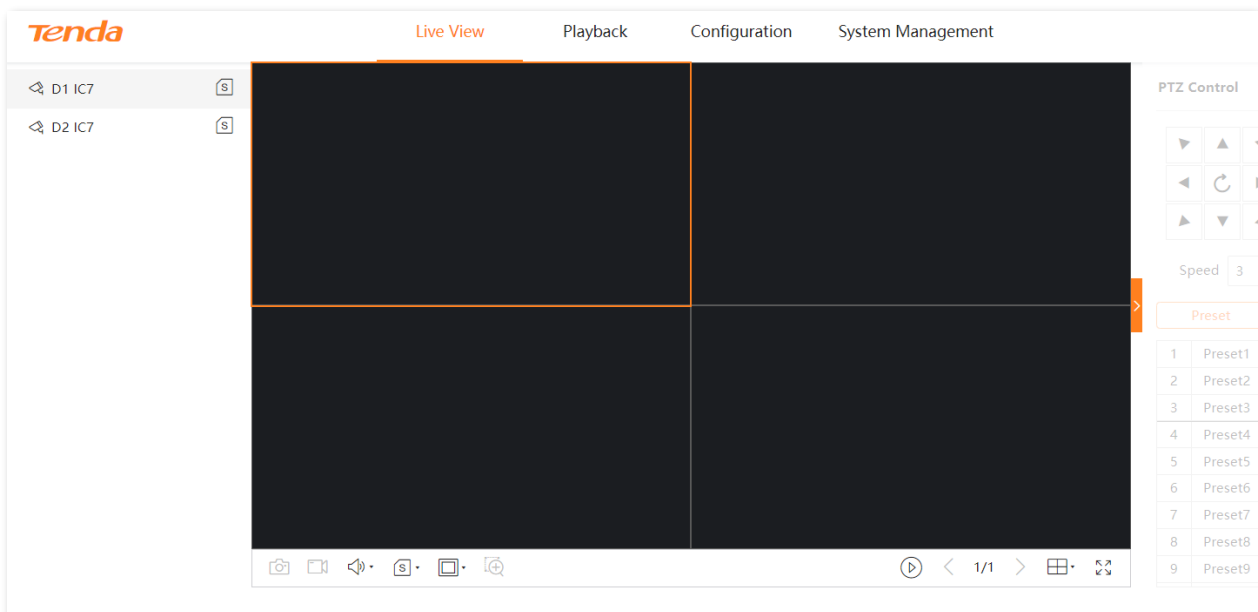

## 5.2 Live View

### 5.2.1 Overview

Click **Live View** to enter the page.





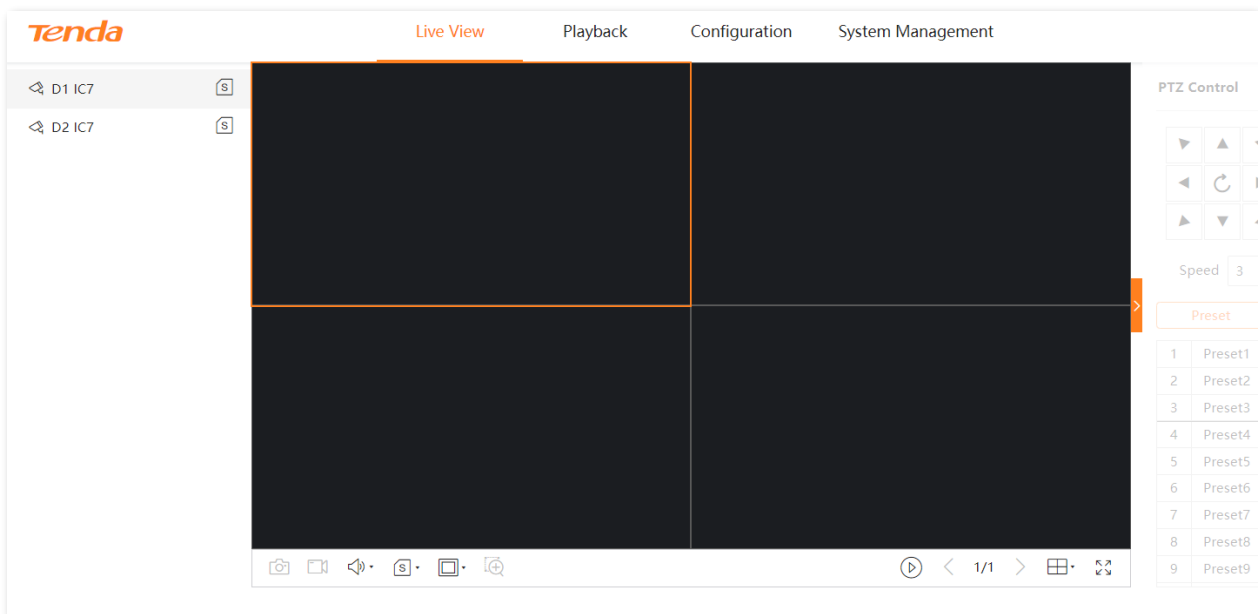

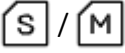

The default page is the live view page after you enter the web UI of the NVR. The number of window divisions of devices varies with different models. The actual model prevails. In this section, you can check the monitoring image of each channel, and perform such basic management as switch division mode, recording and PTZ control for the channel or camera.

Some descriptions of parameters and functions are as follows. Please refer to the [Live View](#) of the GUI chapter for other content.

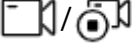

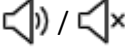
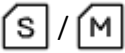
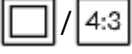
#### Parameter description

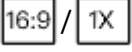
| Parameter   | Description  |
|---|--|
|  | Camera.<br>Double-click the icon to start/stop the preview of this channel. By default, the preview is not performed.<br>A green dot icon at the upper-right of the icon indicates that the monitoring image is being previewed. |

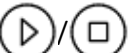
| Parameter   | Description   |
|---|---|
|    | They are located on the left side of the page.<br>Click them to check or set the stream of a single channel.  |
|    | Capture.<br>Click it to take a screenshot of the currently selected monitoring image of the channel and save it to the local computer.  |
|    | Recording.<br>Click  to start recording, and click  to stop recording. The recording files will be automatically saved to the local computer. |
|    | Click them to adjust the video volume of all channels.  |
|    | They are located at the bottom of the page.<br>Click them to set the stream of all online channels.   |
|  | Click them to adjust the ratio of the monitoring image display, or display the monitoring image in its original size (  ).   |
|  |   |
|  | Area zoom-in.<br>Click it to select a specific area of the channel to zoom in on this area through the mouse. Click it again to stop zooming in.<br>Refer to <a href="#">Zoom in</a> function of the web UI chapter for details.  |
|  | Click them to start/stop previewing all channel monitoring.   |
| PTZ Control   | It specifies the monitoring direction and patrol of PTZ cameras or domes that can be managed. Only PTZ cameras can be edited.<br>Please refer to <a href="#">PTZ Control</a> of the GUI chapter for details.  |

## 5.2.2 Preview the Monitoring Image of Each Channel

### Preview the Monitoring Image of Single Channel

Assume that you want to preview the monitoring image of D3.

#### Procedure:

**Step 1** [Log in to the web UI of the NVR.](#)

**Step 2** Click **Live View**, then double-click the channel on the left side, which is D3 in this example.

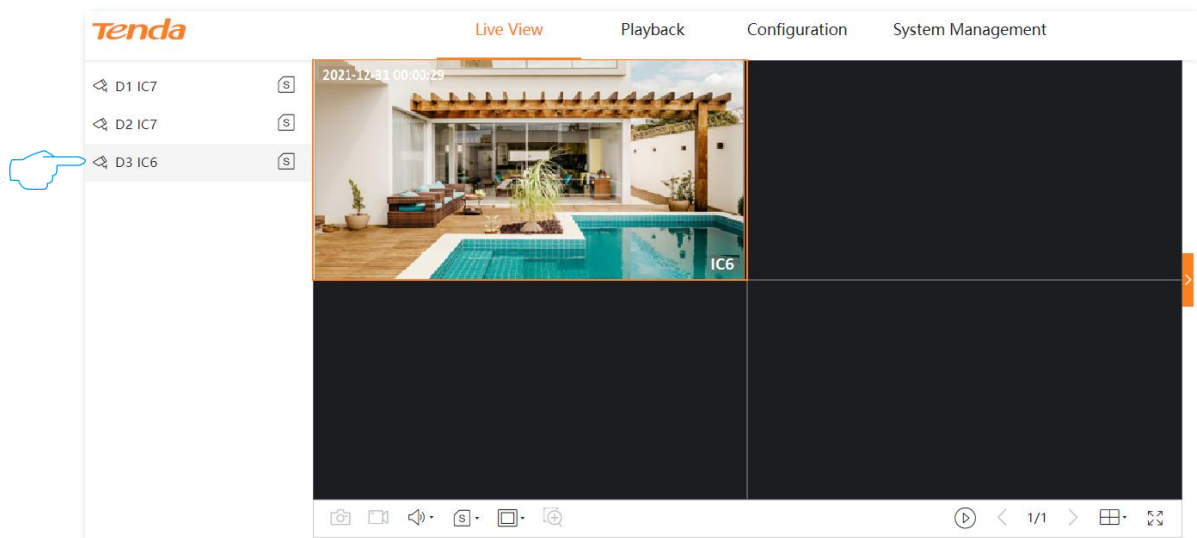

---End

## Preview the Monitoring Image of All Channel

Assume that you want to preview the monitoring image of all channels.

**Procedure:**

**Step 1** [Log in to the web UI of the NVR.](#)

**Step 2** Click **Live View**, then click  at the bottom of the page.

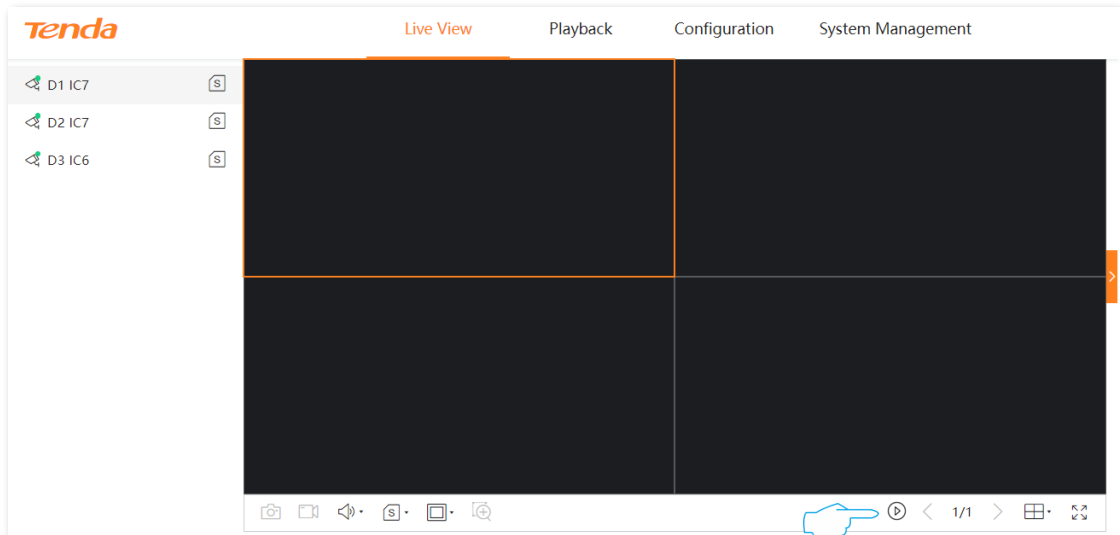

---End

The monitoring images of all channels are previewed successfully.

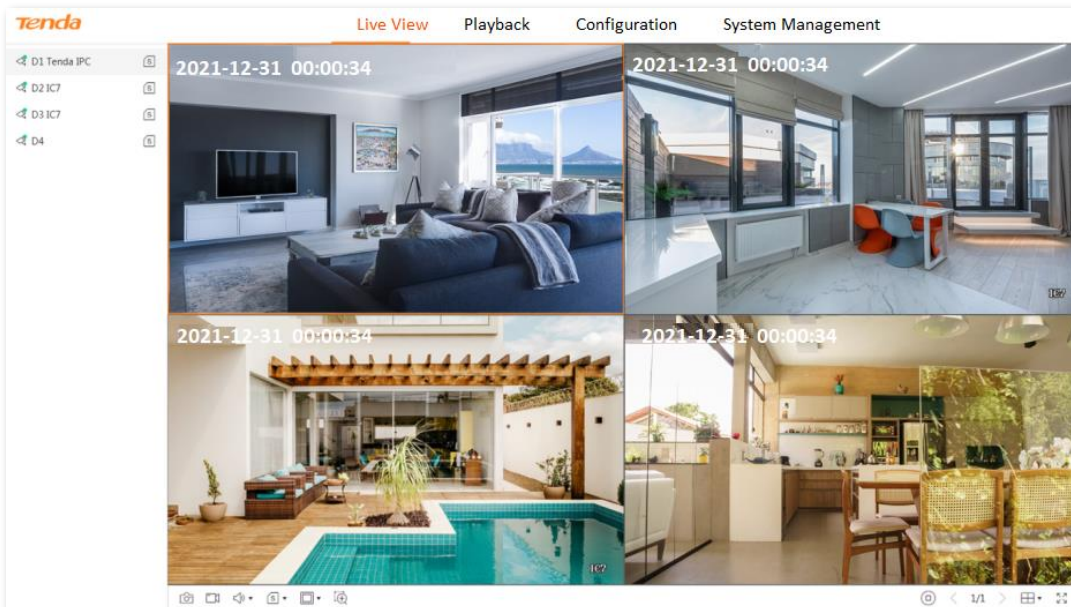

## 5.2.3 Zoom in

The zoom-in function enables you to zoom in on a specific area of the monitoring image to check the details.

### Procedure:

**Step 1** [Log in to the web UI of the NVR.](#)

**Step 2** Click **Live View**.

**Step 3** Select the channel you want to zoom in on the monitoring image, which is D3 in this example.

**Step 4** Click  at the bottom of the page.

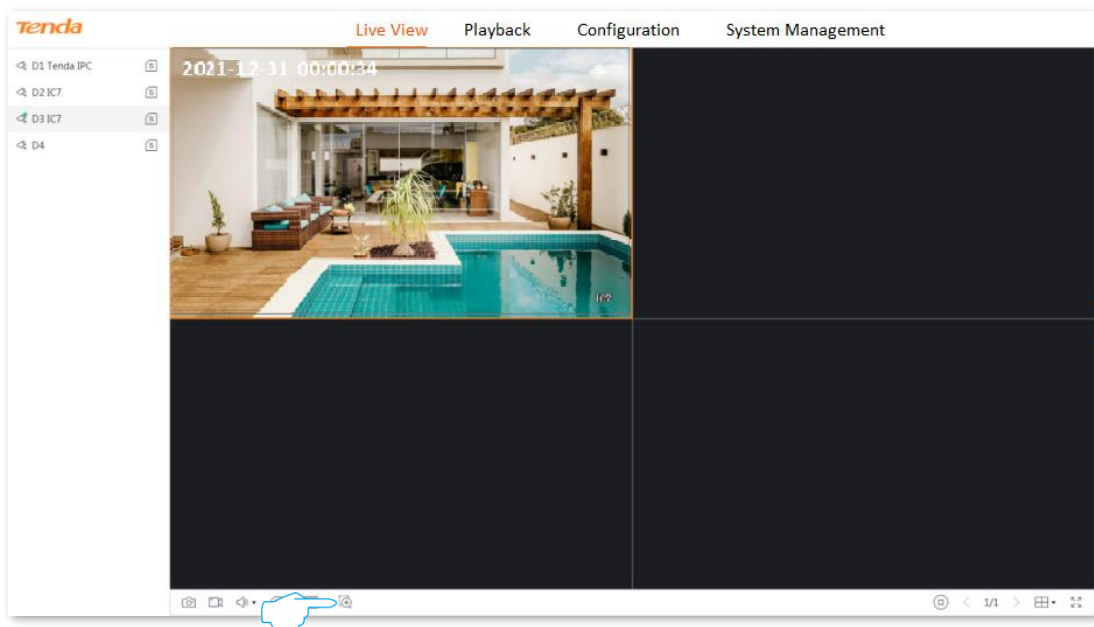

**Step 5** Use the mouse to select the area you want to zoom in.

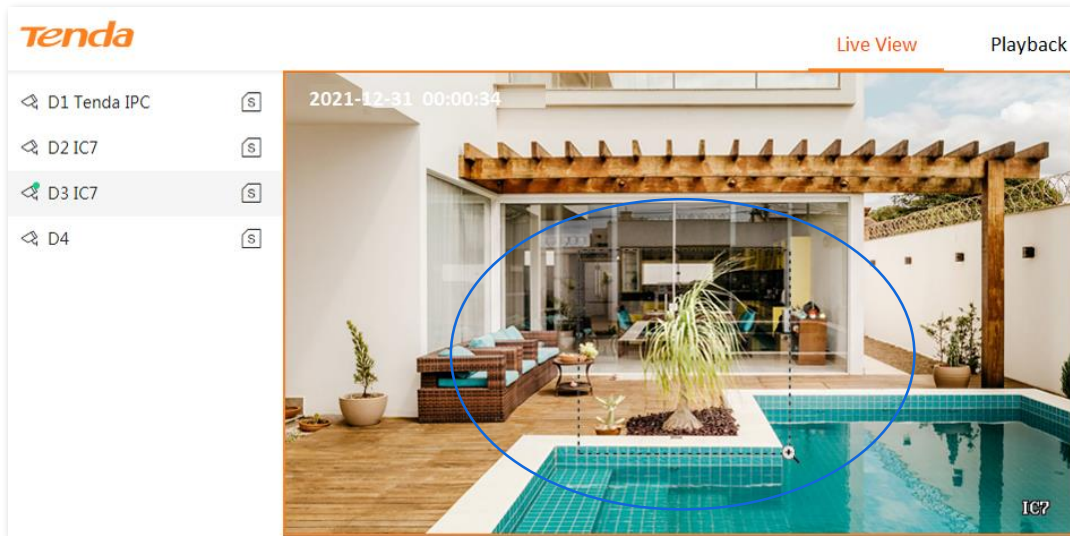

---End

The area is zoomed in successfully. You can check the details of this area.

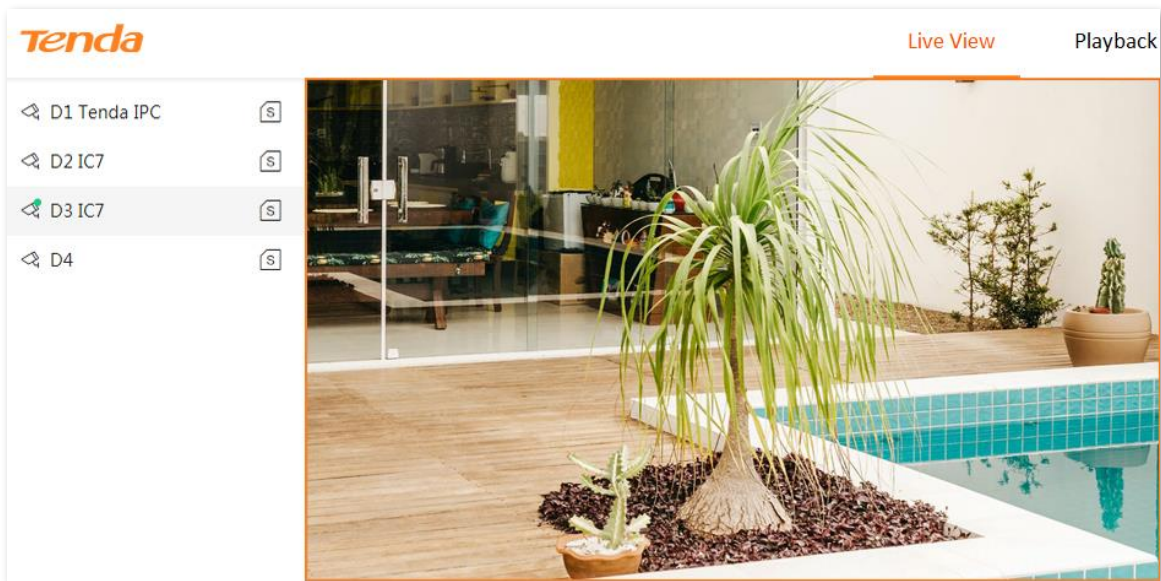



## 5.3 Playback

### 5.3.1 Overview



Click **Playback** to enter the page.

The channel playback is supported for now. It indicates that you can search and play back the corresponding recording file according to the channel and date. You can perform such operations as checking, capturing, clipping and exporting for recording files as required.

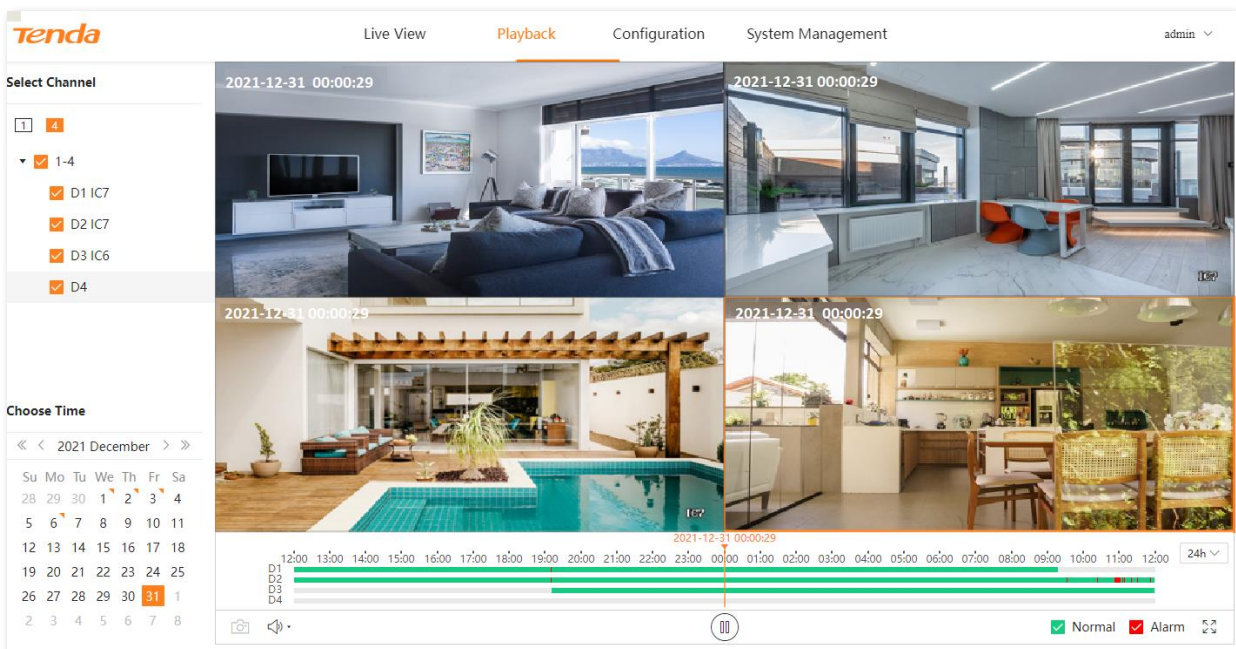
Some descriptions of parameters and functions are as follows. Refer to the [Playback](#) for details.



## Parameter description

| Parameter   | Description   |
|---|---|
| Time Bar  | <p>It specifies the recording and time under the current filter conditions.</p> <ul style="list-style-type: none"><li>– Use the mouse to drag the time bar to the left or right, and the playback interface will start to play back from the time point of the time bar.</li><li>– The time bar color varies with recoding file types. Green means normal recording and red means alarm recording.</li></ul> <p> <b>TIP</b></p> <p>Up to 4 channels can be displayed. If you select more than 4 channels, only the currently selected channel will be displayed.</p> |
|  | <p>Capture.</p> <p>Take a screenshot of the currently selected monitoring image of the channel and save it to the local computer.</p>   |

## 5.3.2 Play Back the Specific Channel

Assume that you want to play back the recordings of D1 to D4 on December 31, 2021.

### Procedure:

**Step 1** [Log in to the web UI of the NVR.](#)

**Step 2** Click **Playback**, and then click .

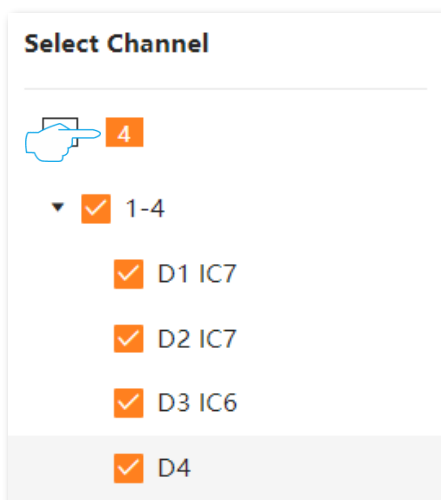

**Step 3** Select the date, which is **December 31, 2021** in this example.

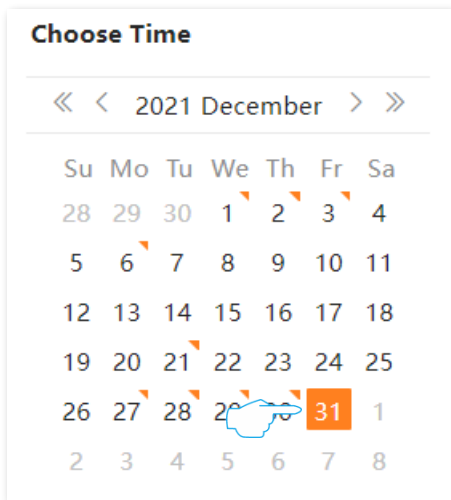

**Step 4** Edit the time bar and play back the control area as required to play back the recordings.

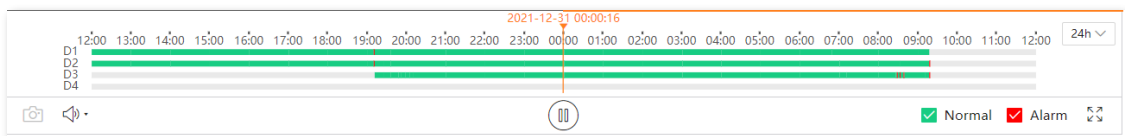

---End

## 5.4 Configuration

On the configuration page, you can configure such main function parameters as channel management, storage management, alarm management and network configuration of the device.

### 5.4.1 Channel

Navigate to **Configuration > Channel**.

You can manage the camera, and configure OSD display, image and video parameters here. Please refer to the [Channel Management](#) for details.

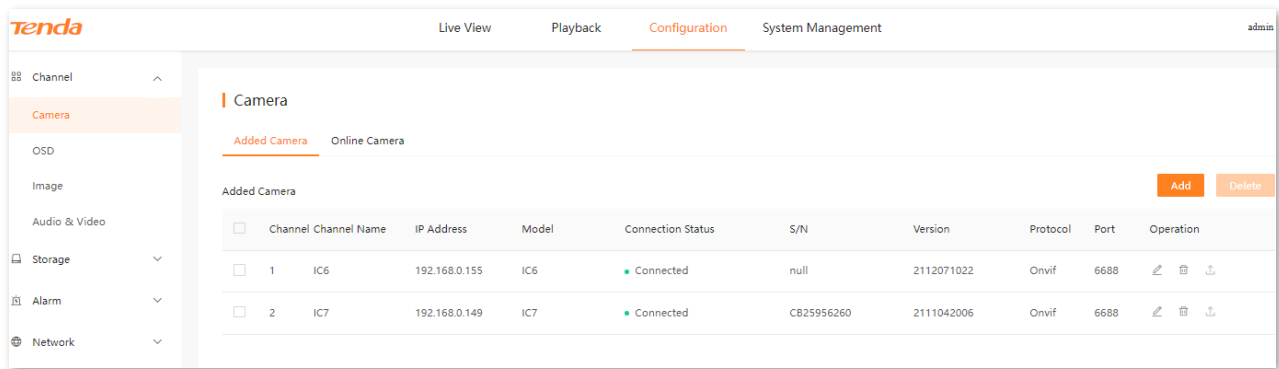

### 5.4.2 Storage Management

#### HDD Management

Navigate to **Configuration > Storage > HDD**.

You can check the HDD status, format the HDD, and make a storage strategy when the HDD space is not enough. Please refer to the [HDD Management](#) for details.

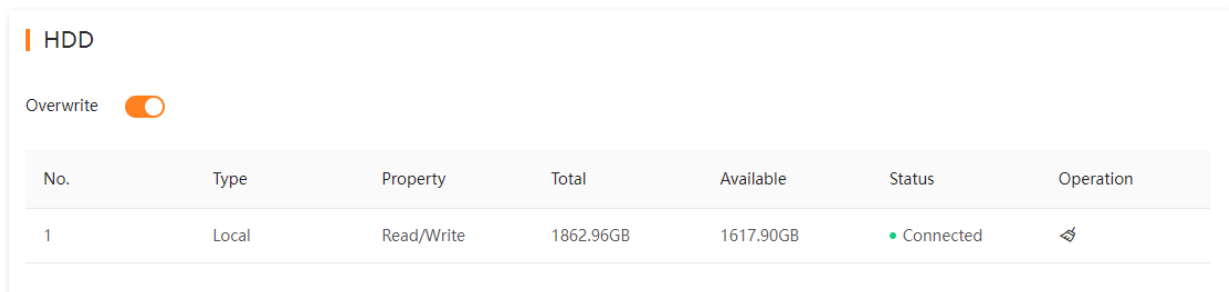

# Schedule

## Overview

Navigate to **Configuration > Storage > Schedule**.

The system will record according to the recording schedule. By default, the system presets the recording schedule of 24 hours continuous normal recording of each channel.

You can modify the recording time and recording type as required. Some description of parameter and function is as follows, please refer to the [Schedule](#) for details.

**Schedule**

Channel: D1 IC7

Recording:

Normal  Alarm

0 1 2 3 4 5 6 7 8 9 10 11 12 13 14 15 16 17 18 19 20 21 22 23 24

Mon. [Green bar] [Edit icon]

Tues. [Green bar] [Edit icon]

Wed. [Green bar] [Edit icon]

Thur. [Green bar] [Edit icon]

Fri. [Green bar] [Edit icon]

Sat. [Green bar] [Edit icon]



Sun. [Green bar] [Edit icon]

Tip: 8 periods are supported for one day at most

Advanced >>

### Parameter & button description

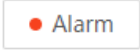
| Parameter                               | Description   |
|---|---|
| <input checked="" type="radio"/> Normal | Green means normal recording. It specifies the NVR always records. Click this button to draw the normal recording time in the period when the recording schedule is not configured. |

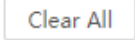
| Parameter   | Description   |
|---|---|
|  | Red means alarm recording. It specifies the NVR will record only when the camera triggers an alarm. Click this button to draw the alarm recording time in the period when the recording schedule is not configured. |
| Time Bar  | Click it to edit the recording type and the recording time, and also to delete the recording period.  |
|  | Click it to synchronize the recording schedule of the current week to other days in the week.   |
|  | Click it to clear the current recording schedule.   |
| Post-record   | Only applicable for <b>Alarm</b> . Click <b>Advanced</b> to enter the page.<br>It specifies the time of continuous recording after an alarm is finished.  |

### Configure Schedule

Assume that you want to set a schedule for D1, D2, D3, and D4 cameras as shown in the table below:

| Recording        | Recording Time | Recording Type   |
|------------------|----------------|------------------|
| Monday to Sunday | 00:00 to 8:00  | Not recording    |
| Monday to Sunday | 8:00 to 12:00  | Alarm recording  |
| Monday to Sunday | 12:00 to 14:00 | Normal recording |
| Monday to Sunday | 14:00 to 18:00 | Alarm recording  |
| Monday to Sunday | 18:00 to 24:00 | Normal recording |



After an alarm recording plan is set for the corresponding channel, the alarm event also needs to be set for the channel in the [Alarm Recording](#).

**Step 1** [Log in to the web UI of the NVR.](#)

**Step 2** Navigate to **Configuration > Storage > Schedule.**

**Step 3** Set the recording schedule of the D1 camera.

1. Select **Channel** as **D1**, and ensure that **Recording** function is enabled.

2. Set the recording schedule for **Monday**.

(1) Click **Monday**, then drag the time bar.

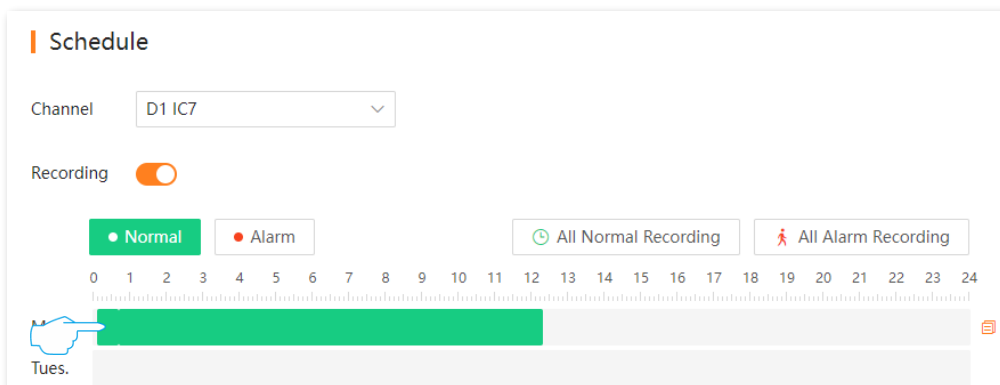

(2) Set the first alarm recording period, which is 8:00 to 12:00 in this example.

Select **Alarm** and set the arming schedule, see the following figure. Click **OK**.

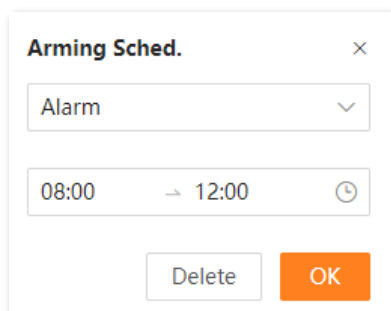

- (3) Set the second alarm recording period, which is 14:00 to 18:00 in this example. Click **Alarm**, and then hold down the left mouse button and drag to draw the recording period on the corresponding time on the Monday time bar.



If the drawn time is not accurate, you can click the period after the drawing is completed, and then select the time again in the pop-up window.

- (4) Refer to substep (3) to set a normal recording schedule, which is 12:00 to 14:00 and 18:00 to 24:00 in this example.
- (5) Click **Save**.



3. Set the recording schedule for Tuesday to Sunday.

(1) Click  behind the Monday time bar.

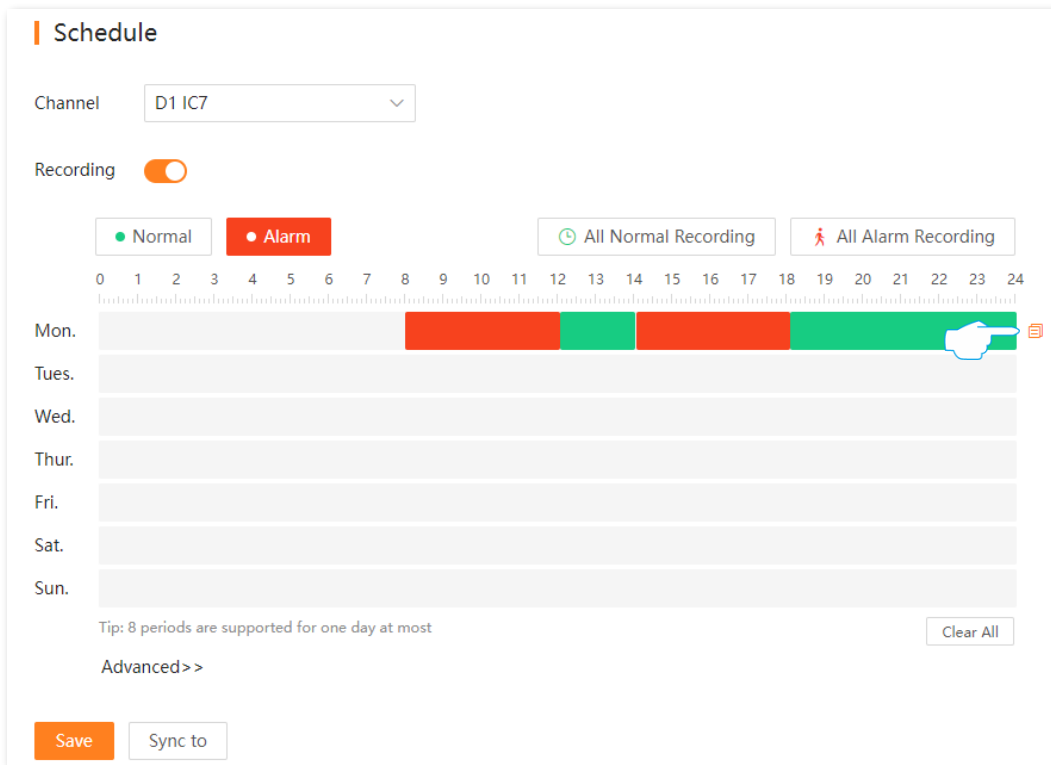

**Schedule**

Channel: D1 IC7

Recording:

Normal  Alarm  All Normal Recording  All Alarm Recording

0 1 2 3 4 5 6 7 8 9 10 11 12 13 14 15 16 17 18 19 20 21 22 23 24

Mon. [Schedule bar with segments: 8-12 Alarm, 12-14 Normal, 14-18 Alarm, 18-24 Normal]

Tues. [Empty bar]

Wed. [Empty bar]

Thur. [Empty bar]

Fri. [Empty bar]

Sat. [Empty bar]

Sun. [Empty bar]

Tip: 8 periods are supported for one day at most

Clear All

Advanced>>

Save Sync to

(2) Select other days in the week to synchronize the recording schedule of Monday, Which is **Tues.** to **Sun.** in this example (You can also tick **All.**), and click **OK**.

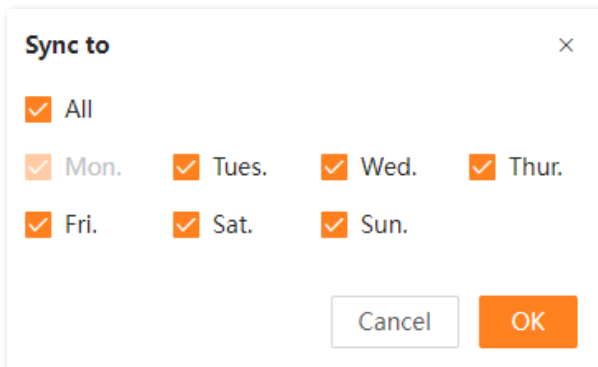

**Sync to** [Close]

All

Mon.  Tues.  Wed.  Thur.

Fri.  Sat.  Sun.

Cancel OK

(3) Click **Save**.

**Schedule**

Channel: D1 IC7

Recording:

Normal  Alarm

|       | 0 | 1 | 2 | 3 | 4 | 5 | 6 | 7 | 8 | 9 | 10 | 11 | 12 | 13 | 14 | 15 | 16 | 17 | 18 | 19 | 20 | 21 | 22 | 23 | 24 |
|-------|---|---|---|---|---|---|---|---|---|---|----|----|----|----|----|----|----|----|----|----|----|----|----|----|----|
| Mon.  |   |   |   |   |   |   |   |   |   |   |    |    |    |    |    |    |    |    |    |    |    |    |    |    |    |
| Tues. |   |   |   |   |   |   |   |   |   |   |    |    |    |    |    |    |    |    |    |    |    |    |    |    |    |
| Wed.  |   |   |   |   |   |   |   |   |   |   |    |    |    |    |    |    |    |    |    |    |    |    |    |    |    |
| Thur. |   |   |   |   |   |   |   |   |   |   |    |    |    |    |    |    |    |    |    |    |    |    |    |    |    |
| Fri.  |   |   |   |   |   |   |   |   |   |   |    |    |    |    |    |    |    |    |    |    |    |    |    |    |    |
| Sat.  |   |   |   |   |   |   |   |   |   |   |    |    |    |    |    |    |    |    |    |    |    |    |    |    |    |
| Sun.  |   |   |   |   |   |   |   |   |   |   |    |    |    |    |    |    |    |    |    |    |    |    |    |    |    |

Tip: 8 periods are supported for one day at most

Advanced >>

**Step 4** Set the recording schedule of other channel cameras.

1. Click  at the bottom of the page, then select the channel you want to synchronize the D1 camera recording schedule, which is **D2** to **D4** in this example. (You can also tick **All**.)
2. Click **Sync**.

Sync to

All  D1  D2  D3

---End

After the setting completes, the D1, D2, D3 and D4 camera will record according to the above schedule.

## 5.4.3 Alarm Recording

### Motion Detection

Navigate to **Configuration > Alarm > Motion Detection**.

Motion detection refers to the detection alarm of moving targets. When a moving target appears on the monitoring image and the moving sensitivity reaches the preset value, the system will alarm and record according to the linkage action you set.

Some descriptions of parameters and functions are as follows. Please refer to the [Motion Detection](#) for details.

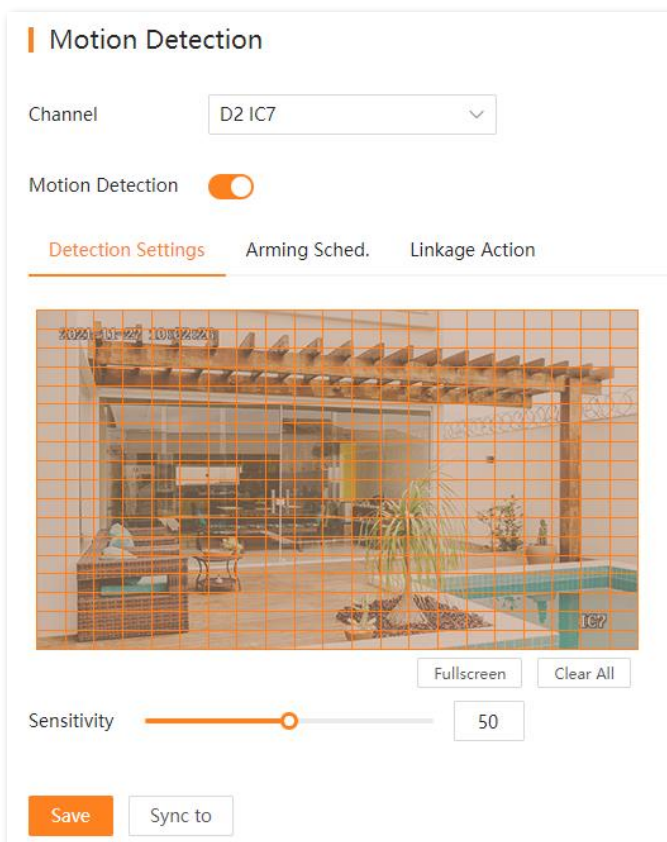

#### Parameter description

| Parameter     | Description  |
|---------------|--|
| Time Bar      | Click it to edit the recording type and recording time, or delete the recording period.  |
| Arming Sched. |  Click it to sync the recording schedule of the current week to other days in the week. |

| Parameter      |                                      | Description   |
|----------------|--------------------------------------|---|
|                | <input type="button" value="Clear"/> | Click it to clear the arming schedule of the current channel.   |
| Linkage Action | Linkage Action                       | <p>It specifies the alarm method of the NVR after an alarm is triggered.</p> <ul style="list-style-type: none"> <li>- <b>Single Screen Display:</b> The alarm channel is displayed on a single screen on the <b>Live View</b> page after an alarm is triggered.</li> <li>- <b>Send Email:</b> The system will send an alarm email to the preset receiver email after an alarm is triggered. You need to set the relevant parameters of email for this alarm method to take effect. Please refer to <a href="#">Email Configuration</a> for details.</li> <li>- <b>Message Notification:</b> The system will send an alarm notification to TDSEE App after an alarm is triggered. The NVR needs to be added successfully through TDSEE App. Please refer to <a href="#">Manage the NVR through TDSEE App</a> for details.</li> </ul> |

## Tempering Detection

Navigate to **Configuration > Alarm > Tampering Detection**.

Tampering detection refers to the tampering detection alarm of the camera lens. When the camera lens is blocked by other objects and the moving sensitivity reaches the preset value, the system will alarm and record according to the linkage action you set.

Some descriptions of parameters and functions are as follows. Please refer to the [Tempering Detection](#) for details.

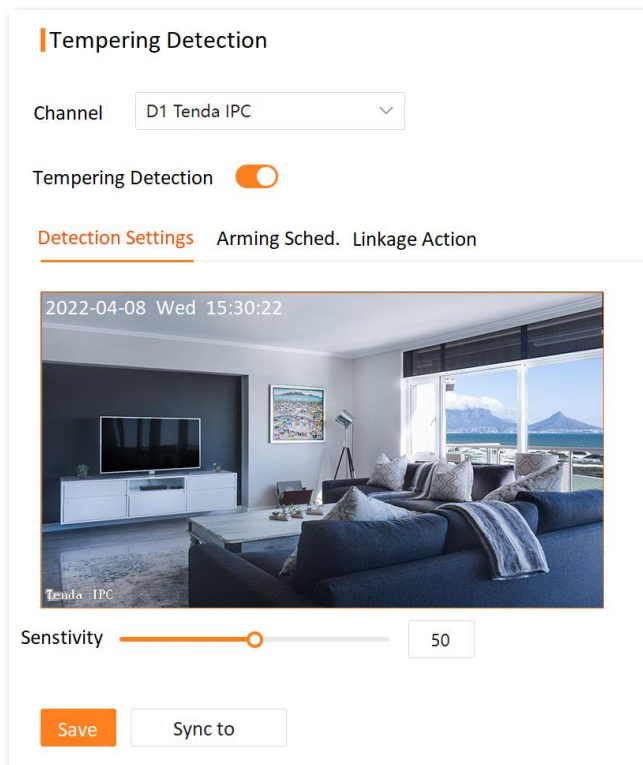

Parameter & button description

| Parameter     | Description   |
|---------------|---|
| Time Bar      | Click it to edit the recording type and recording time, or delete the recording period. |
| Arming Sched. | Click it to sync the recording schedule of the current week to other days in the week.  |
| Clear         | Click it to clear the arming schedule of the current channel.                           |

| Parameter      |                | Description   |
|----------------|----------------|---|
| Linkage Action | Common Linkage | <p>It specifies the alarm method of the NVR after an alarm is triggered.</p> <ul style="list-style-type: none"> <li>– <b>Single Screen Display:</b> The alarm channel is displayed on a single screen on the <b>Live View</b> page after an alarm is triggered.</li> <li>– <b>Send Email:</b> The system will send an alarm email to the preset receiver email after an alarm is triggered. You need to set the relevant parameters of email for this alarm method to take effect. Please refer to <a href="#">Email Configuration</a> for details.</li> <li>– <b>Message Notification:</b> The system will send an alarm notification to TDSEE App after an alarm is triggered. The NVR needs to be added successfully through TDSEE App. Please refer to <a href="#">Manage the NVR through TDSEE App</a> for details.</li> </ul> |

## Exception Detection

Navigate to **Configuration > Alarm > Exception Detection**.

Exception detection refers to the detection and alarm of exception events. When an exception event occurs, the system will be alarmed according to the linkage action you set.

Some descriptions of parameters and functions are as follows. Please refer to the [Exception Detection](#) for details.

**Exception Detection**

Exception Type

Linkage Action  Monitor pop-up window  Send Email  Message Notification

## Parameter description

| Parameter      | Description   |
|----------------|---|
| Linkage Action | <p>It specifies the alarm method of the NVR after an alarm is triggered.</p> <ul style="list-style-type: none"><li>– <b>Single Screen Display:</b> The alarm channel is displayed on a single screen on the <b>Live View</b> page after an alarm is triggered.</li><li>– <b>Send Email:</b> The system will send an alarm email to the preset receiver email after an alarm is triggered. You need to set the relevant parameters of email for this alarm method to take effect. Please refer to <a href="#">Email Configuration</a> for details.</li><li>– <b>Message Notification:</b> The system will send an alarm notification to TDSEE App after an alarm is triggered. The NVR needs to be added successfully through TDSEE App. Please refer to <a href="#">Manage the NVR through TDSEE App</a> for details.</li></ul> |

## 5.4.4 Network Configuration

Navigate to **Configuration > Network**. The N6P-4H is taken as an example here.

On the network configuration page, you can perform the network configuration, including internet settings, cloud service, PoE configuration, port configuration, email configuration, DDNS and UPnP. Please refer to [Network Configuration](#) in the GUI chapter for details.

The screenshot displays the Tenda web interface for network configuration. The top navigation bar includes 'Live View', 'Playback', 'Configuration' (highlighted), and 'System Management'. The left sidebar lists various settings: Channel, Storage, Alarm, Network (expanded), Internet (selected), Cloud Service, Port Config, Email, DDNS, and UPnP. The main panel is titled 'Internet' and contains the following configuration options:

- DHCP:
- IP Address: 192 . 168 . 0 . 188
- Subnet Mask: 255 . 255 . 255 . 0
- Default Gateway: 192 . 168 . 0 . 1
- Auto Obtain DNS:
- Primary DNS: 192 . 168 . 0 . 1
- Secondary DNS: 0 . 0 . 0 . 0
- MTU: 1500
- MAC Address: 50:2b:73:f9:09:40

A 'Save' button is located at the bottom of the configuration area.

## 5.5 System Management

### 5.5.1 Device Info

Navigate to **Configuration > Device Info > Device Info**.

You can check such basic information as device name, device model, firmware version, firmware release time and system time of the NVR.

Please refer to [Device Info](#) in the GUI chapter for details.

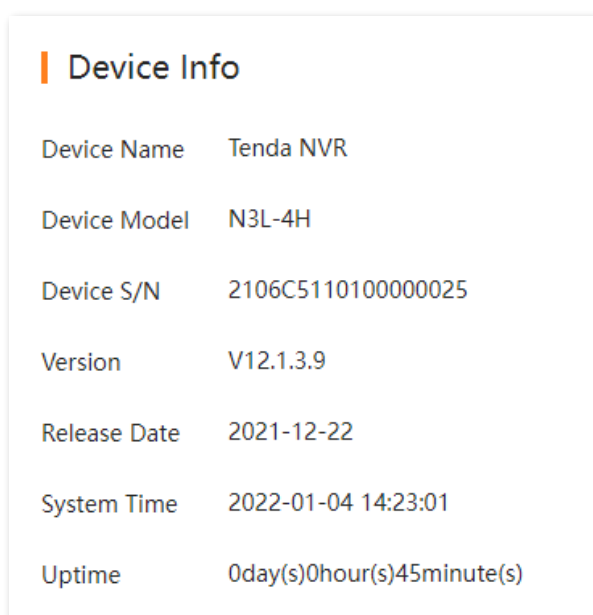

| Device Info  |                            |
|--------------|----------------------------|
| Device Name  | Tenda NVR                  |
| Device Model | N3L-4H                     |
| Device S/N   | 2106C5110100000025         |
| Version      | V12.1.3.9                  |
| Release Date | 2021-12-22                 |
| System Time  | 2022-01-04 14:23:01        |
| Uptime       | 0day(s)0hour(s)45minute(s) |

### 5.5.2 Device Log

Navigate to **Configuration > Device Info > Device Log**.

The system log records such information as running status, configuration information, alarm information, and exception conditions of the system. You can use system logs for viewing alarm information and troubleshooting. It is recommended to check and back up logs regularly.

Please refer to [System Log](#) in the GUI chapter for details.



**Device Log**

Type:  Time:  →

| No. | Time                | Type      | Detail   |
|-----|---------------------|-----------|--|
| 1   | 2022-01-04 13:37:39 | Operation | { "Shutdown Time": "2000-00-00 00:00:00" }               |
| 2   | 2022-01-04 13:37:41 | Operation | { "Disk": "1", "Flag": "1" }                             |
| 3   | 2022-01-04 13:37:42 | Exception | { "Channel": "4" }                                       |
| 4   | 2022-01-04 13:37:45 | Exception | { "Channel": "1", "Result": "Disconnect", "State": "5" } |
| 5   | 2022-01-04 13:44:41 | Operation | { "Session": "2" }                                       |

5 items in total

## 5.5.3 System Configuration

### Basic Settings

Navigate to **System Management > System Settings > Basics**.

You can configure such basic parameters as the device name and output resolution of the NVR.

Please refer to [Basic Configuration](#) in the GUI chapter for details.

**Basics**

Device Name:

Output Resolution:

## Time

Navigate to **System Management > System Settings > Time**.

You can configure the system time of the NVR. To ensure that the time-based functions of the NVR take effect normally, the system time of the NVR must be accurate.

Please refer to [Time Settings](#) in the GUI chapter for details.

### Time

System Time 2022-04-06 13:48:25

Time Zone (UTC+08:00) Beijing, Chongqing

Date Format YYYY-MM-DD

Time Synchronization  Manual  Internet

Server Address time.windows.com

Port 123

Interval 10  minute(s) (range: 1 - 10080)

DST

Type  Date  Week

Start Time January  1  0:00

End Time January  1  0:00

Offset Time 60  minute(s)

## 5.5.4 System Maintenance

### Device Upgrade

Navigate to **System Management > System Maintenance > Device Upgrade**.

The firmware upgrade enables the NVR to get new or more stable performance. The NVR only supports **Local Upgrade** for now.



- To avoid damage to the NVR, please use the correct upgrade file. Generally, the suffix of the firmware upgrade file is .bin.
- During upgrading, do not directly cut off the power supply of the NVR; it may cause upgrade failure or damage the NVR.

#### Upgrade firmware:

**Step 1** [Log in to the web UI of the NVR.](#)

**Step 2** Navigate to **System Management > System Maintenance > Device Upgrade**.

**Step 3** (If you have got the upgrade file, skip this step) Click **Tenda Download Center**, and then download the latest upgrade file of the corresponding model NVR to the local computer and unzip it.

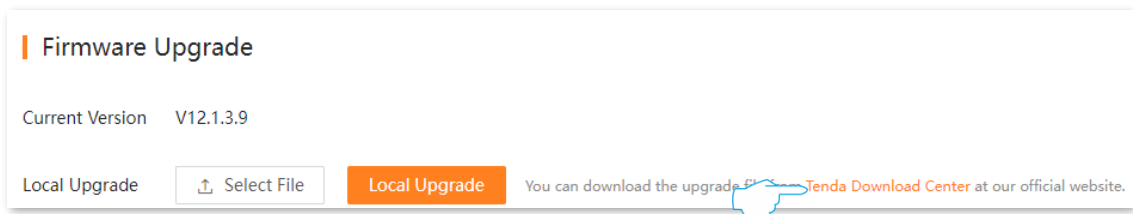

**Step 4** Click **Select File**.

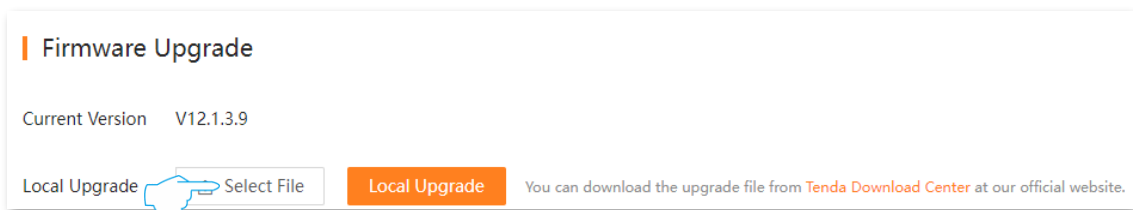

**Step 5** Target the firmware file downloaded previously, and click **Open**. The following figure is for reference only.

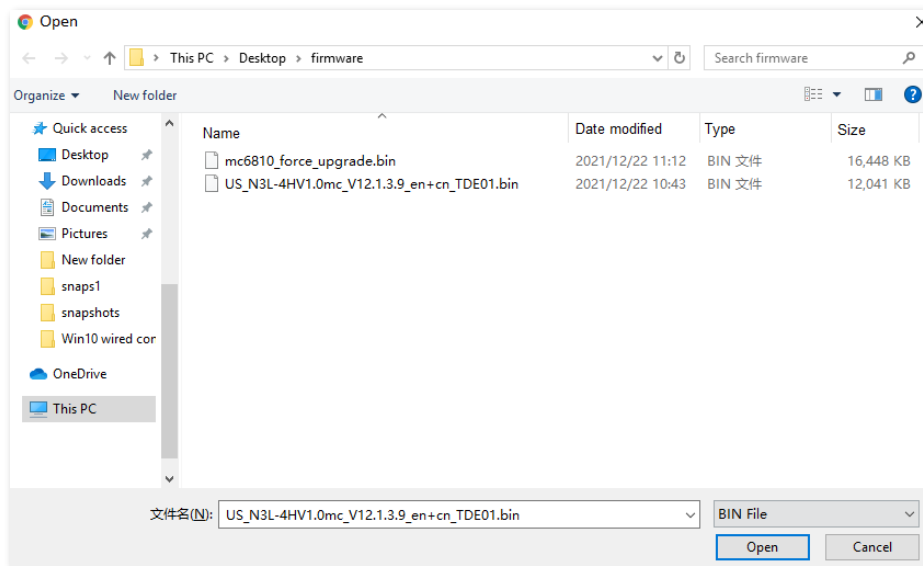

**Step 6** Click **Local Upgrade**.

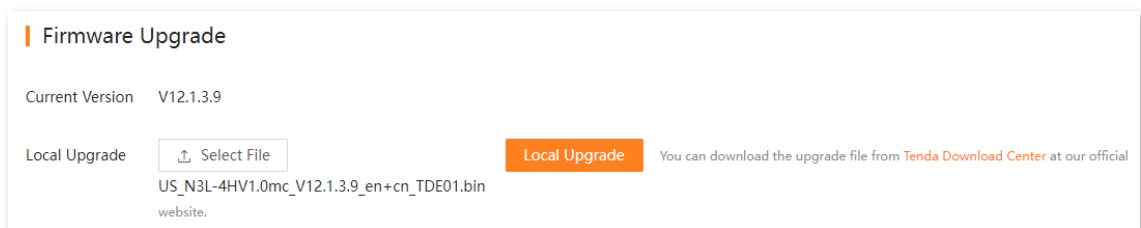

---End

Wait for a moment until the ongoing process finishes. After the upgrade completes, log in to the web UI of the NVR again, and check the **Current Version** on the **Firmware Upgrade** page to confirm whether the firmware version is correct.

## Configuration Management

Navigate to **System Management > System Maintenance > Configuration Mgmt.**

If the NVR is running slowly, or a configuration error occurs, you can try to restore the NVR.

Please refer to the [Restore Settings](#) in the GUI chapter for details.

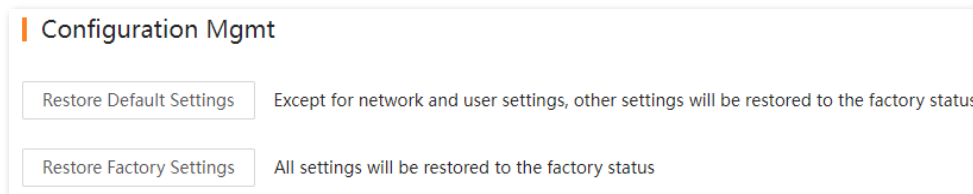

## Reboot Settings

Navigate to **System Management > System Maintenance > Reboot Settings.**

The reboot can prevent performance decrease and instability of the NVR due to long-time running. You can reboot the NVR now, or set the NVR to automatically reboot periodically during idle time.

Assume that you want to the NVR to automatically reboot at 3:00:00 from Monday to Friday.

### Procedure:

- Step 1** [Log in to the web UI of the NVR.](#)
- Step 2** Navigate to **System Management > System Maintenance > Reboot Settings.**
- Step 3** Enable the **Scheduled Reboot** function.
- Step 4** Select the reboot date, which is **Monday to Friday** in this example.
- Step 5** Set the reboot time, which is **03:00:00** in this example.
- Step 6** Click **Save** at the bottom of the page.

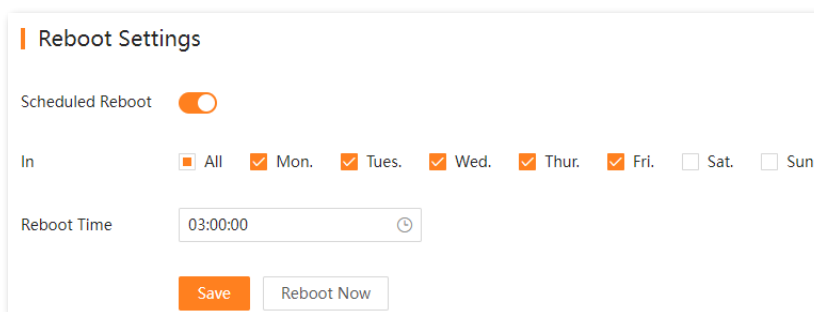

---End

After the setting completes, the NVR will automatically reboot from Monday to Friday at 3 am.

## System Service

Navigate to **System Management > System Maintenance > System Service**.

You can configure the SSH debugging function here.

Please refer to [SSH Debugging](#) in the GUI chapter for details.

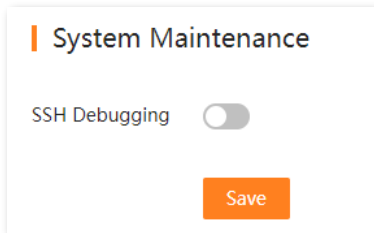

## 5.5.5 User Management

Navigate to **System Management > Users**.

You can modify and add the login account information of the NVR here to prevent unauthorized users from entering the GUI of the NVR to change the settings.

Please refer to [User Management](#) in the GUI chapter for details.

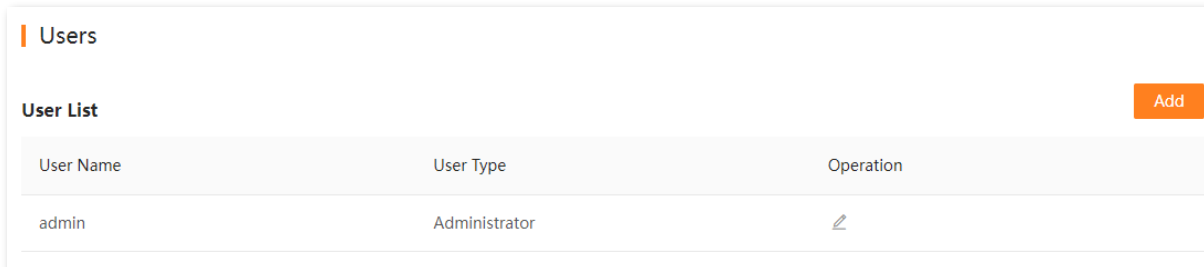

# Appendix

## Acronyms and Abbreviations

| Acronym or Abbreviation | Full Spelling                       |
|-------------------------|-------------------------------------|
| BLC                     | Back Light Compensation             |
| CBR                     | Constants Bits Rate                 |
| DDNS                    | Dynamic Domain Name Server          |
| DHCP                    | Dynamic Host Configuration Protocol |
| DNS                     | Domain Name System                  |
| DST                     | Daylight Saving Time                |
| GUI                     | Graphical User Interface            |
| HDD                     | Hard Disk Drive                     |
| HLC                     | Highlight Compensation              |
| HTTP                    | HyperText Transfer Protocol         |
| HTTPS                   | Hypertext Transfer Protocol Secure  |
| IMAP                    | Internet Message Access Protocol    |
| IP                      | Internet Protocol                   |
| IPv4                    | Internet Protocol Version 4         |
| IR                      | Infrared Radiation                  |
| ISP                     | Internet Service Provider           |
| LAN                     | Local Area Network                  |
| MAC                     | Medium Access Control               |

| <b>Acronym or Abbreviation</b> | <b>Full Spelling</b>                    |
|--------------------------------|---|
| MTU                            | Maximum Transmission Unit               |
| NAT                            | Network Address Translation             |
| NTFS                           | New Technology File System              |
| NTP                            | Network Time Protocol                   |
| NTSC                           | National Television Standards Committee |
| ONVIF                          | Open Network Video Interface Forum      |
| OSD                            | On-screen display                       |
| PAL                            | Phase Alteration Line                   |
| PLR                            | Packet Loss Rate                        |
| RTSP                           | Real Time Streaming Protocol            |
| SATA                           | Serial Advanced Technology Attachment   |
| SMTP                           | Simple Mail Transfer Protocol           |
| SSH                            | Secure Shell                            |
| SSID                           | Service Set Identifier                  |
| SSL                            | Secure Sockets Layer                    |
| TCP                            | Transmission Control Protocol           |
| TLS                            | Transport Layer Security                |
| UDP                            | User Datagram Protocol                  |
| UI                             | User Interface                          |
| UTC                            | Coordinated Universal Time              |
| UPnP                           | Universal Plug and Play                 |
| UUID                           | Universal Unique Identifier             |
| VBR                            | Variable Bit Rate                       |



| <b>Acronym or Abbreviation</b> | <b>Full Spelling</b> |
|--------------------------------|----------------------|
| WDR                            | Wide Dynamic Range   |
| Wi-Fi                          | Wireless Fidelity    |